

SDP8/SDP18 Preset Metered Dispense Valve Pulse FC Enabled

3A6673H
EN

For dispensing oil, automatic transmission fluid (ATF), gear oils, and antifreeze.

Not approved for use in explosive atmospheres or hazardous locations. For professional use only.

See page 4 for model information.

1500 psi (10 MPa, 103 bar) Maximum Working Pressure



Important Safety Instructions

Read all warnings and instructions in this manual and related system manuals before using the equipment. Save all instructions.

NOTICE

The metered dispense valve is designed to dispense petroleum-based lubricants, and antifreeze only. Brake cleaner and/or harsh solvents may damage the plastic components.

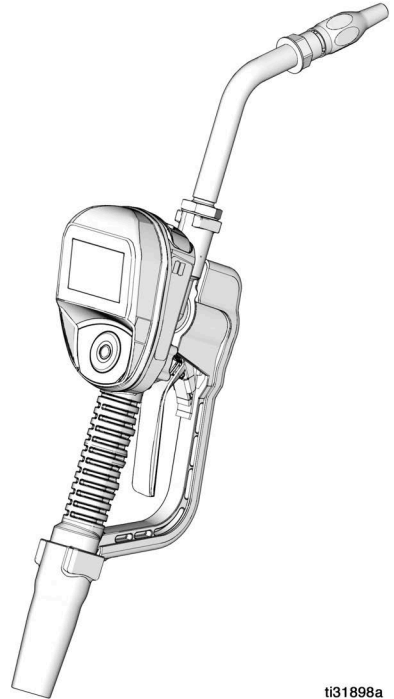

ti31898a

Contents

Contents	2
Models	4
Warnings	5
Overview	7
Metered Dispense Valve	7
Navigation Pad	7
Locking and Unlocking the Trigger	7
Opening and Closing the Nozzle	8
Typical Installation	9
Mounting Bracket	9
Oil Bar	9
Installation	10
Pressure Relief Procedure	10
Grounding	10
Pre-Installation Procedure	10
Flushing	11
Install the Metered Dispense Valve	11
Install the Extension Tube	12
Install the Nozzle	12
Preset Mode	13
Main Menu Screen	13
Calibration	13
Manual Calibration	15
Alternate Calibration	16
DISPENSE	18
Preset Dispense	19
STOP Function	20
TOTAL	21
UTILITY MENU	21
DEVICE INFORMATION	21
RESET	22
SET-UP SCREENS	22
UNIT OF MEASURE	23
BANNER	23
CALIBRATE	24
“+++”	24
LANGUAGE	24
PRESET	24
PRESET SETUP SCREEN	25
Creating a PRESET	25
FLIP DISPLAY	25
LOCK SETTINGS	26
DEVICE INFORMATION	27









RESET	27
GO BACK	27
Pulse FC Mode	28
Enable Pulse FC Mode	28
Activation	29
Calibration	29
Manual Calibration	31
DISPENSE	32
Screen Identification	32
END Function	33
UTILITY MENU	33
DEVICE INFORMATION	33
FLIP DISPLAY	34
GO BACK	34
Service	35
Battery Replacement	35
Troubleshooting	36
Fault Codes	38
Parts	39
Parts	40
Related Kits	40
Technical Specifications	41
California Proposition 65	41
FCC / IC Notice	42
Graco 5-Year Meter and Valve Warranty	43
Graco Information	44

Models

Model	Swivel	Extension	Nozzle	Fluid	Max Volumetric Flow Rate	
					GPM	LPM
26C384	1/2 npt	Rigid	Automatic	Oil	8	30
26C385	1/2 npt	Rigid	Antifreeze	Antifreeze	8	30
26C354	1/2 npt	Flexible	Automatic	Oil	8	30
26C355	1/2 npt	Flexible	Antifreeze	Antifreeze	8	30
26C356	1/2 npt	Rigid	High Flow	Oil	18	68
26C357	1/2 npt	Flexible	High Flow	Oil	18	68
26C358	1/2 npt	Gear Lube	Manual	Gear Lube	5	19
26C360	3/4 npt	Rigid	High Flow	Oil	18	68
26C361	3/4 npt	Flexible	High Flow	Oil	18	68
26C362	1/2 bspp	Rigid	Automatic	Oil	8	30
26C363	1/2 bspp	Rigid	Antifreeze	Antifreeze	8	30
26C364	1/2 bspp	Flexible	Automatic	Oil	8	30
26C365	1/2 bspp	Flexible	Antifreeze	Antifreeze	8	30
26C368	1/2 bspp	Rigid	High Flow	Oil	18	68
26C369	1/2 bspp	Flexible	High Flow	Oil	18	68
26C370	1/2 bspp	Gear Lube	Manual	Gear Lube	5	19
26C372	3/4 bspp	Rigid	High Flow	Oil	18	68
26C373	3/4 bspp	Flexible	High Flow	Oil	18	68
26C374	1/2 bspt	Rigid	Automatic	Oil	8	30
26C375	1/2 bspt	Rigid	Antifreeze	Antifreeze	8	30
26C376	1/2 bspt	Flexible	Automatic	Oil	8	30
26C377	1/2 bspt	Flexible	Antifreeze	Antifreeze	8	30
26C378	1/2 bspt	Rigid	High Flow	Oil	18	68
26C379	1/2 bspt	Flexible	High Flow	Oil	18	68
26C380	1/2 bspt	Gear Lube	Manual	Gear Lube	5	19
26C382	3/4 bspt	Rigid	High Flow	Oil	18	68
26C383	3/4 bspt	Flexible	High Flow	Oil	18	68

Warnings

The following warnings are for the setup, use, grounding, maintenance, and repair of this equipment. The exclamation point symbol alerts you to a general warning and the hazard symbols refer to procedure-specific risks. When these symbols appear in the body of this manual or on warning labels, refer back to these Warnings. Product-specific hazard symbols and warnings not covered in this section may appear throughout the body of this manual where applicable.

 WARNING	
    	<p>SKIN INJECTION HAZARD</p> <p>High-pressure fluid from dispensing device, hose leaks, or ruptured components will pierce skin. This may look like just a cut, but it is a serious injury that can result in amputation. Get immediate surgical treatment.</p> <ul style="list-style-type: none"> • Do not point dispensing device at anyone or at any part of the body. • Do not put your hand over the fluid outlet. • Do not stop or deflect leaks with your hand, body, glove, or rag. • Follow the Pressure Relief Procedure when you stop dispensing and before cleaning, checking, or servicing equipment. • Tighten all fluid connections before operating the equipment. • Check hoses and couplings daily. Replace worn or damaged parts immediately.
 	<p>EQUIPMENT MISUSE HAZARD</p> <p>Misuse can cause death or serious injury.</p> <ul style="list-style-type: none"> • Do not operate the unit when fatigued or under the influence of drugs or alcohol. • Do not exceed the maximum working pressure or temperature rating of the lowest rated system component. See Parts in all equipment manuals. • Use fluids and solvents that are compatible with equipment wetted parts. See Parts in all equipment manuals. Read fluid and solvent manufacturer's warnings. For complete information about your material, request Safety Data Sheets (SDSs) from distributor or retailer. • Turn off all equipment and follow the Pressure Relief Procedure when equipment is not in use. • Check equipment daily. Repair or replace worn or damaged parts immediately with genuine manufacturer's replacement parts only. • Do not alter or modify equipment. Alterations or modifications may void agency approvals and create safety hazards. • Make sure all equipment is rated and approved for the environment in which you are using it. • Use equipment only for its intended purpose. Call your distributor for information. • Route hoses and cables away from traffic areas, sharp edges, moving parts, and hot surfaces. • Do not kink or over bend hoses or use hoses to pull equipment. • Keep children and animals away from work area. • Comply with all applicable safety regulations.

Warnings

WARNING



FIRE AND EXPLOSION HAZARD

When flammable fluids are present in the work area, such as gasoline and windshield wiper fluid, be aware that flammable fumes can ignite or explode. To help prevent fire and explosion:

- Use equipment only in well-ventilated area.
- Eliminate all ignition sources, such as cigarettes and portable electric lamps.
- Ground all equipment in the work area.
- Keep work area free of debris, including rags and spilled or open containers of solvent and gasoline.
- Do not plug or unplug power cords or turn lights on or off when flammable fumes are present.
- Use only grounded hoses.
- **Stop operation immediately** if static sparking occurs or you feel a shock. Do not use equipment until you identify and correct the problem.
- Keep a working fire extinguisher in the work area.



PERSONAL PROTECTIVE EQUIPMENT

Wear appropriate protective equipment when in the work area to help prevent serious injury, including eye injury, hearing loss, inhalation of toxic fumes, and burns. Protective equipment includes but is not limited to:

- Protective eye wear, and hearing protection.
- Respirators, protective clothing, and gloves as recommended by the fluid and solvent manufacturer.

Overview

Metered Dispense Valve

NOTE: The metered dispense valve can be set up to be used without a Pulse FC system, or with a Pulse FC system with the installation of a Pulse FC Starter kit (P/N 26C401).

Navigation Pad

The Navigation Pad (FIG. 1) includes four (4) navigation arrows (UP, DOWN, LEFT, RIGHT) and a center button (ENTER).

ARROWS: Moves the cursor on the display.
ENTER: Selects or stores an entry.

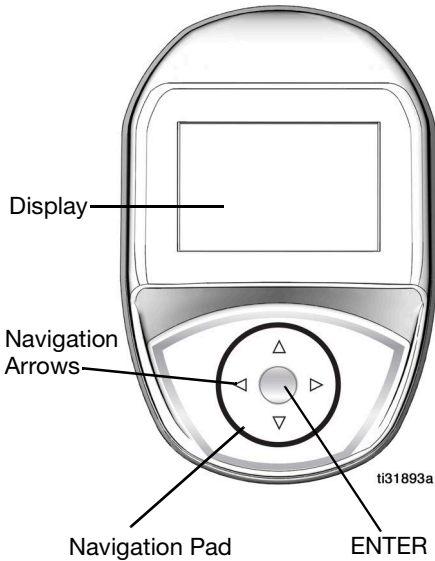

FIG. 1

Locking and Unlocking the Trigger

The locking trigger locks the trigger in the dispense position as shown in FIG. 2. To release the lock, firmly squeeze the trigger to the handle.

NOTE: Do not leave the metered dispense valve unattended during a dispense.

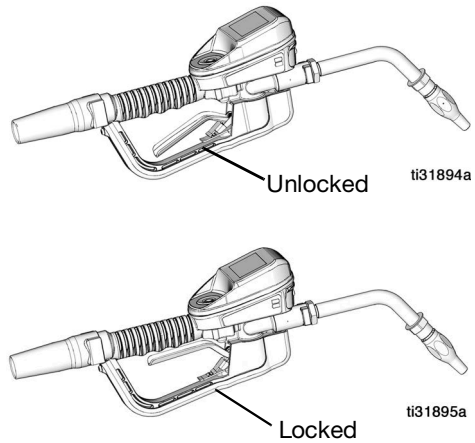

FIG. 2

Opening and Closing the Nozzle

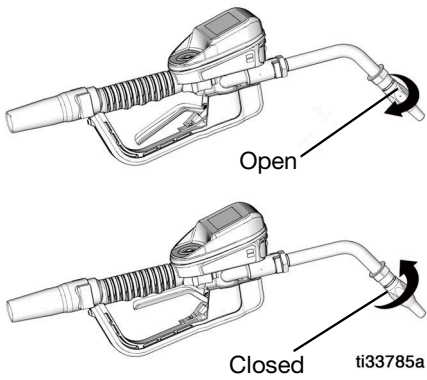

FIG. 3

- To open the nozzle, rotate the nozzle clockwise.
- To close the nozzle, rotate the nozzle counter-clockwise.

NOTE: Close the nozzle to prevent dripping when not in use.

Typical Installation

The typical installation shown in FIG. 4 is only a guide. It is not a complete system design. Contact your Graco distributor for assistance in designing a system to suit your needs.

The metered dispense valve is not designed for in-line installation.

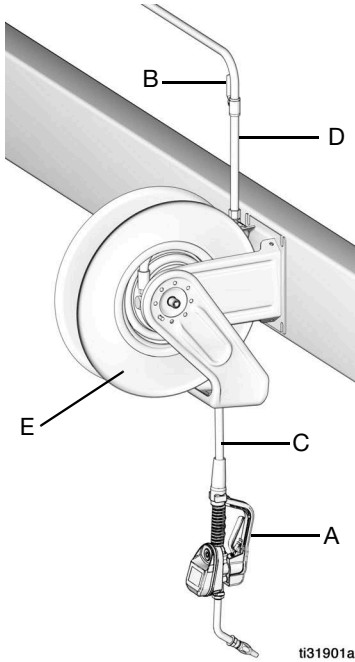

FIG. 4

Ref	Description
A	Metered dispense valve
B	Fluid shut-off valve
C	Hose
D	Hose reel fluid inlet hose
E	Hose reel

A Thermal Relief Kit (not shown) is required. The kit required will vary by pump selected.

Mounting Bracket

Mounting Bracket Kit 249440 is available for mounting the metered dispense valve on a console.

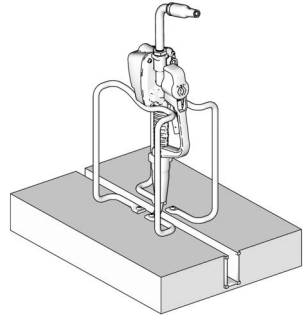

FIG. 5

Oil Bar

An Oil Bar Kit is available for mounting one to three metered dispense valves. Contact your Graco Distributor for ordering details.

NOTE: The Utility Menu provides an option to flip the metered dispense valve display for easy viewing when the metered dispense valve is installed in the Oil Bar.

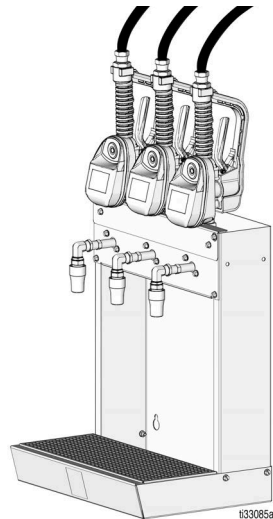

FIG. 6

Installation

Pressure Relief Procedure



Follow the Pressure Relief Procedure whenever you see this symbol.



This equipment stays pressurized until pressure is manually relieved. To help prevent serious injury from pressurized fluid, such as skin injection, splashing fluid and moving parts, follow the Pressure Relief Procedure when you stop dispensing and before cleaning, checking, or servicing the equipment.

1. Turn off the power supply to the pump or close the fluid shut off valve (B).
2. Open the nozzle.
3. Authorize and activate a dispense.
4. Trigger the metered dispense valve into a waste container to relieve pressure.
5. Open any bleed-type master air valves and fluid drain valves in the system.
6. Leave the drain valve open until ready to pressurize the system.

Grounding



The equipment must be grounded to reduce the risk of static sparking. Static sparking can cause fumes to ignite or explode. Grounding provides an escape wire for the electric current.

Follow manufacturer's recommendations to ground the pump and fluid supply container.

Ground the hose and reel or console. Leave at least two threads bare when using PTFE tape. The bare threads ensure a ground is maintained.



FIRE HAZARD

Conductive metal surfaces on the metered dispense valve must not make contact with any positively charged metal surface, including (but not limited to), the starter solenoid terminal, alternator terminal or battery terminal. Such contact could cause electrical arcing and a fire.

To maintain grounding continuity when flushing or relieving pressure: hold a metal part of the metered dispense valve firmly to the side of a grounded metal pail, then trigger the metered dispense valve.

Hoses: Only use electrically conductive hoses. Check electrical resistance of hoses. If total resistance to ground exceeds 29 megohms, replace the hose immediately.

Pre-Installation Procedure



1. **Relieve pressure. Follow Pressure Relief Procedure**, page 10.
2. Close fluid shut-off valve (B, FIG. 4, page 9).
3. Ground the hose and reel or console (see **Grounding**, page 10).

NOTICE

- If this is a new installation or if the fluid lines are contaminated, flush the lines before installing the metered dispense valve. Contaminated lines could cause the metered dispense valve to leak.
- Never dispense compressed air with a metered dispense valve. Dispensing compressed air damages the metered dispense valve.

4. Flush equipment. See **Flushing**, page 11.

Flushing

The equipment was tested with lightweight oil, which is left in the fluid passages to protect parts. To avoid contaminating the fluid, flush the equipment with a compatible solvent before use.



1. Close the fluid shut-off valve (B, see FIG. 4, page 9) at each dispense position.
2. Make sure:
 - the main fluid outlet valve at the pump is closed.
 - the air pressure to the pump motor is adjusted to minimize the system flow rate without the metered dispense valve attached.
 - the air valve is open.
3. Slowly open the main fluid outlet valve.
 - a. Place the hose end (with no metered dispense valve connected) into a container for waste oil.
 - b. Secure the hose in the container to avoid it becoming loose during flushing.
 - c. For multiple dispense positions, first flush the dispense position farthest from the pump then work toward the pump.
4. Slowly open the fluid shut-off valve (B) at the dispense position. Flush a sufficient amount of oil to ensure that the entire system is clean; then close the valve.
5. Repeat Step 4 at all other positions.

Install the Metered Dispense Valve



1. Follow **Pressure Relief Procedure**, page 10.

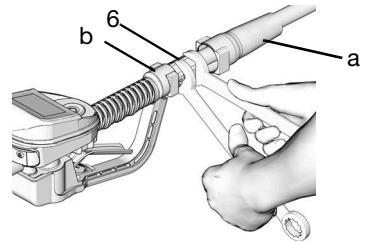

FIG. 7

2. Slide the swivel boot (a) back, over the hose, small end first to access the swivel fitting (6) (FIG. 7).
3. Apply thread sealant to the male threads of the hose fitting. Thread the hose fitting (b) into the metered dispense valve swivel (6). Use two wrenches to tighten securely (FIG. 7).

NOTE: Allow the sealant to cure according to the manufacturer's recommendations before circulating fluid through the system.

Installation

Install the Extension Tube

1. Adjust nut (c) on extension (2) so that the maximum thread engagement of the extension can be utilized (FIG. 8).

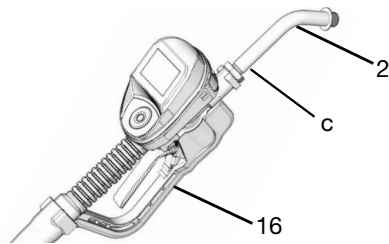

FIG. 8

2. Thread extension (2) into housing until it bottoms out (FIG. 8).
3. Align extension (2) with metered dispense valve housing and handle (16) (FIG. 8).
4. Firmly tighten nut (c) (FIG. 8).

Install the Nozzle

1. Thread nozzle (3) onto extension (2) (FIG. 9).

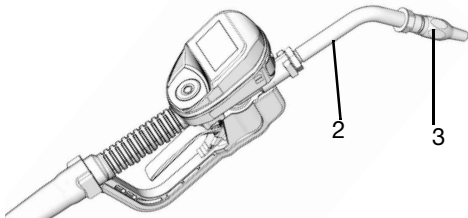
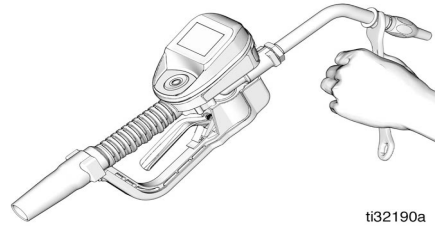

FIG. 9

2. With an open-end adjustable wrench on the flats of the nozzle bushing, tighten firmly (FIG. 10).



ti32190a

FIG. 10

NOTICE

- To prevent nozzle damage, *only* tighten nozzle with wrench on flats of the nozzle bushing as shown in FIG. 10.
- Do not disassemble the bushing from the nozzle. Disassembly will affect the performance of the nozzle.

3. Open the automatic twist lock nozzle and all fluid shut-off valves. Start pump to pressurize system.
4. To ensure dispensing accuracy, purge all air from the fluid lines and metered dispense valve before use.
5. Set the system flow to the desired flow rate. This is typically done by adjusting the pump air pressure.

Preset Mode

Main Menu Screen

This screen provides access to the main metered dispense valve functions:

- **DISPENSE**, page 18
- **TOTAL**, page 21
- **UTILITY MENU**, page 21

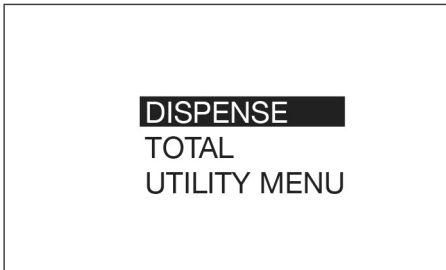

FIG. 11

This calibration procedure requires a one (1) quart or one (1) liter calibrated, volumetric flask. If a one (1) quart or one (1) liter calibrated, volumetric flask is not available, see Alternate Calibration instructions, page 16.

To calibrate the metered dispense valve:

1. Use the UP or DOWN ARROW button on the keypad to highlight UTILITY MENU (FIG. 12) and then press the center ENTER button on the keypad to select the UTILITY MENU option.

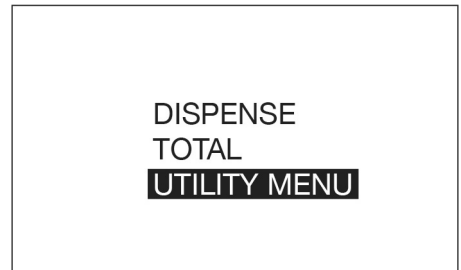

FIG. 12

Calibration

NOTE:

- This calibration procedure requires a one (1) quart or one (1) liter clean, calibrated, volumetric flask. When the meter is configured to display fluid volume in pints, quarts, or gallons, the calibration procedure will require a one (1) quart calibrated, volumetric flask be used. When the meter is configured in liters, a one (1) liter volumetric flask is required for calibration.
- The metered dispense valve must be flushed and primed prior to calibration (see **Flushing**, page 11).
- The metered dispense valve should be calibrated prior to using it for the first time. Calibrating the metered dispense valve assures that the dispenses are accurate.

Calibration factors can vary due to fluid viscosity and flow rate.

Calibrate the metered dispense valve for specific fluids at nominal flow rates.

2. Use the UP or DOWN ARROW button on the keypad to highlight SET-UP (FIG. 13) and then press the center ENTER button on the keypad to select the SET-UP option.

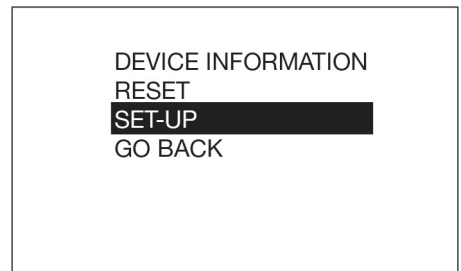

FIG. 13

Preset Mode

- Use the UP or DOWN ARROW button on the keypad to highlight CALIBRATE (FIG. 14) and then press the center ENTER button on the keypad to select the CALIBRATE option.



FIG. 14

- The calibration k-factor screen shown in FIG. 15 displays.

NOTE: The number shown on the display is the k-factor the meter is currently using. After completing the calibration procedure this number may be the same or different than what is currently shown on the display.

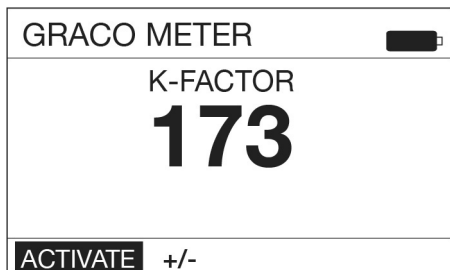

FIG. 15

- Select ACTIVATE and press the center ENTER button on the keypad to begin metered dispense valve calibration (FIG. 15).

NOTE: The +/- on this screen is used for Manual Calibration. See **Manual Calibration** instructions on page 15.

- Dispense exactly one (1) quart or one (1) liter of fluid into the one quart or one liter clean, calibrated, volumetric flask.

NOTE: During the dispense the metered dispense valve will not display the volume dispensed. The volume dispensed is only determined by the flask measurement. A screen displays (FIG. 16) during the calibration dispense.

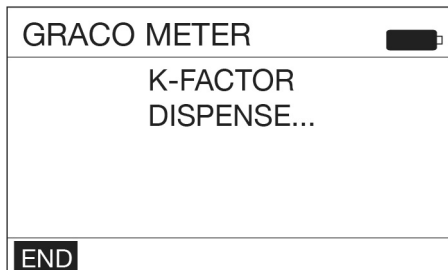

FIG. 16

- When exactly one (1) quart or one (1) liter of fluid is dispensed into the flask use the center ENTER button on the keypad to select END. A screen displaying the quantity of fluid dispensed displays (FIG. 17 shows an example of the dispensed volume screen).

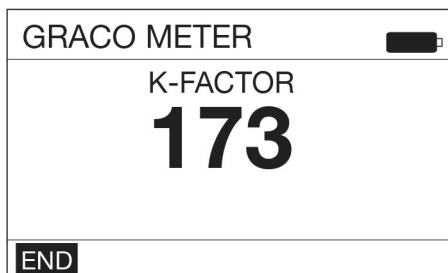

FIG. 17

- Press the center ENTER button on the keypad again to select END and save the new calibration factor.
- After selecting END the following screen (FIG. 18) displays.

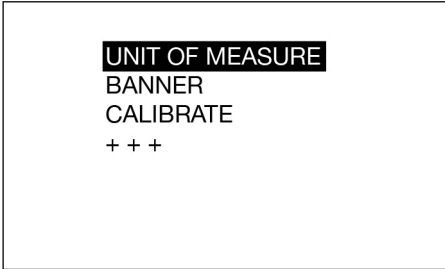

FIG. 18

Manual Calibration

NOTE: This Manual Calibration procedure is used when the k-factor is known and a simple adjustment of the displayed k-factor is needed to set that number.

- Follow steps 1- 4 of the **Calibration** instructions, beginning on page 13.
- Use the RIGHT ARROW button on the keypad to highlight +/- and press the center ENTER button on the keypad to select the +/- option (FIG. 19).

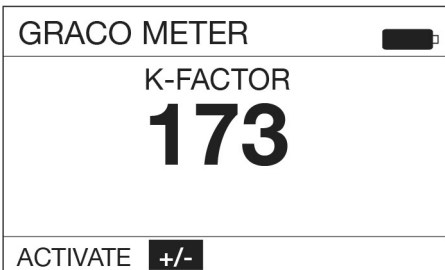

FIG. 19

- The k-factor adjustment screen shown in FIG. 20 displays.

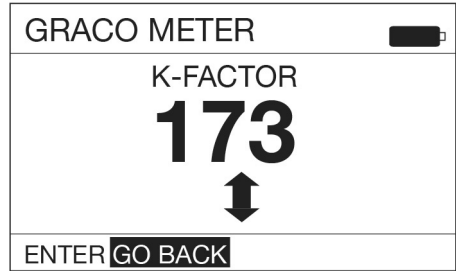

FIG. 20

- Use the UP and DOWN ARROW to increase or decrease the displayed k-factor until the new k-factor displays on the screen.

NOTE: Selecting the GO BACK Function on this screen returns the display to the previous screen (shown in FIG. 19).

- Be sure ENTER is highlighted in the lower left corner of the display as shown in FIG. 21. Press the center ENTER button on the keypad to save the new calibration factor.



FIG. 21

Preset Mode

- After selecting ENTER the following screen (FIG. 22) displays.

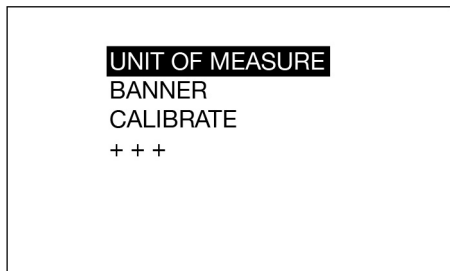

FIG. 22

Alternate Calibration

NOTE: This alternate calibration procedure is used when a one (1) quart or one (1) liter calibrated, volumetric flask is not available.

- Dispense a known volume of fluid into any sized clean, calibrated, volumetric flask. Note this volume as the VOLUME DISPENSED (see Calculating k-factor, Step 11, page 17).
- Record the volume displayed on the metered dispense valve. Note this volume as the VOLUME DISPLAYED ON THE METERED DISPENSE VALVE (see Calculating the k-factor, Step 11, page 17).
- Use the UP or DOWN ARROW button on the keypad to highlight UTILITY MENU (FIG. 23) and then press the center ENTER button on the keypad to select the UTILITY MENU option.

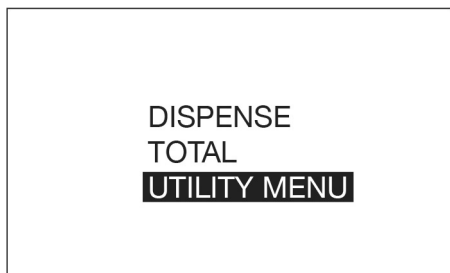

FIG. 23

- Use the UP or DOWN ARROW button on the keypad to highlight SET-UP (FIG. 24) and then press the center ENTER button on the keypad to select the SET-UP option.

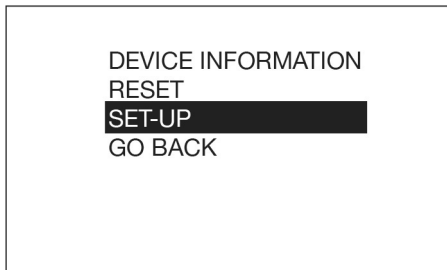

FIG. 24

- Use the UP or DOWN ARROW button on the keypad to highlight CALIBRATE (FIG. 25) and then press the center ENTER button on the keypad to select the CALIBRATE option.

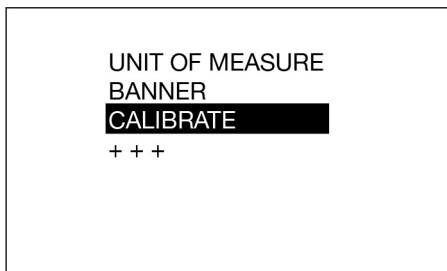

FIG. 25

- The calibration k-factor screen shown in FIG. 26 displays.

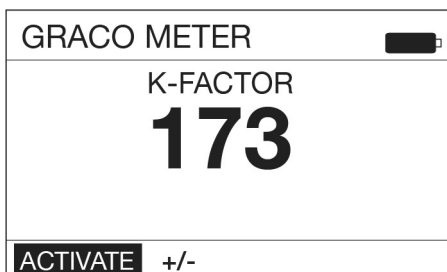

FIG. 26

- Use the RIGHT ARROW button on the keypad to highlight +/- and press the center ENTER button on the keypad to select the +/- option (FIG. 27).

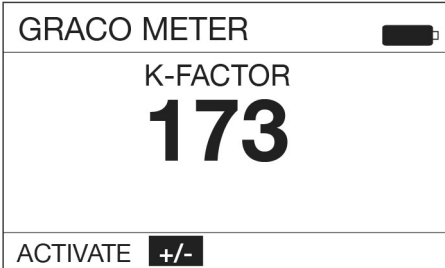

FIG. 27

- The k-factor adjustment screen shown in FIG. 28 displays.

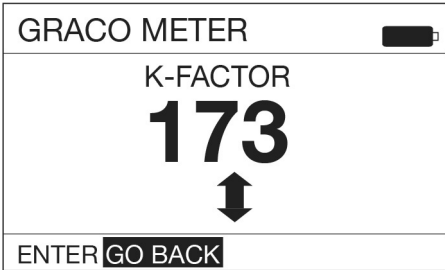

FIG. 28

- Use the UP and DOWN ARROW to increase or decrease the displayed k-factor (FIG. 29) until the new k-factor displays on the screen.



FIG. 29

- Note the current k-factor is displayed. In the example shown in FIG. 30 the k-factor is 169.

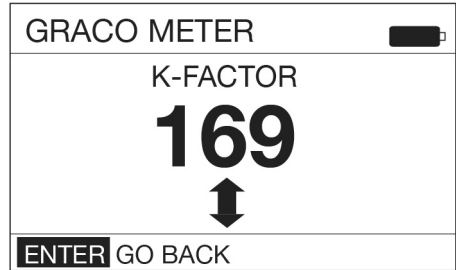

FIG. 30

- Calculate the new k-factor using the following equation:

$$K_{\text{new}} = \frac{(K_{\text{current}}) \times (\text{VOLUME DISPLAYED ON METER})}{(\text{VOLUME DISPENSED})}$$

Example:

$K_{\text{current}} = 169$

Volume displayed on metered dispense valve = 0.970 quart

Volume dispensed = 1 quart

$$K_{\text{new}} = \frac{(169) \times (0.970 \text{ quarts})}{(1.0 \text{ quarts})} = 163.9$$

Round to the nearest whole number: $163.9 = 164$.

NOTE: The unit of measurement for both volumes must be the same in the above equation.

- Use the UP or DOWN ARROWS to adjust the k-factor to the k-factor (K_{new}) calculated in Step 11.

See **Table 1**, page 18 for recommended fluid calibration factors.

NOTE: The calibration number may vary slightly due to temperature or rate of flow.

Table 1

Fluid	Calibration Factor
Oil (10W30)	173
Gear Lube	173
ATF	173
Antifreeze	150

- Press the center ENTER button on the keypad to complete the calibration operation and save the new calibration factor.

DISPENSE

DISPENSE SCREEN

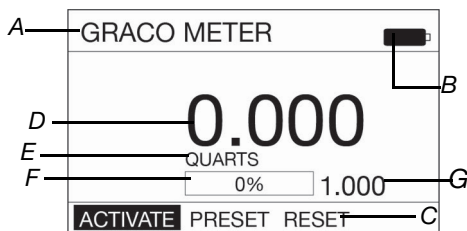

PRESET ADJUSTMENT SCREEN

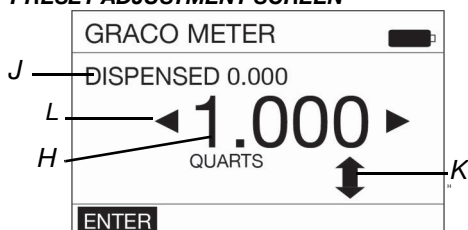

Fig. 31

A BANNER - Unique identification name. See *Utility Menu/Set-Up/BANNER*, page 23 for instructions for creating the banner.

B BATTERY INDICATOR - When the batteries are fully charged, the battery is completely filled in. As the battery discharges, the amount of battery that is filled-in declines.

C FUNCTION COMMAND - Function command options appear at the bottom of the display when applicable to the task being performed. Options when in the Dispense mode include:

ACTIVATE - Activates the trigger to begin a dispense.

PRESET - Preset dispense adjustment screen displays.

RESET - Resets the dispense settings.

ENTER - Saves changes or updates.

NOTE: Additional function commands will appear throughout the following instructions, when applicable

D DISPENSED FLUID COUNTER- As fluid is dispensed, this number increases to reflect the quantity of fluid that is being dispensed.

NOTE: If RESET was not selected after the previous dispense was completed, the amount of fluid dispensed in the previous dispense will be shown in this field. If RESET was selected, the field will show 0.000.

E UNIT OF MEASURE - Pints, Quarts, Gallons or Liters. For instructions on setting the Unit of Measure see UTILITY MENU/SET-UP/UNIT OF MEASURE, page 23.

F PROGRESS BAR - Graphic representation of the progression of the dispense shown by gradually filling-in the empty space in the bar. A textual representation of the progress is also shown in a percentage format.

G PRESET AMOUNT - The volume of fluid that the meter is currently set up to dispense in PRESET Mode. See UTILITY MENU/SET-UP/PRESET, page 24.

H ADJUSTABLE PRESET - Shows the volume of fluid that the meter is currently set up to dispense in PRESET. Press the UP or DOWN arrow on the keypad to increase or decrease this quantity.

J DISPENSED - The amount of fluid previously dispensed.

K INCREASE/DECREASE ARROW - The up/down arrow on the screen indicates the user can increase or decrease the PRESET quantity before starting the dispense. Use the UP or DOWN ARROW button on the keypad to increase or decrease the PRESET amount.

L PRESET SELECTION - The left and right arrow on the screen indicate the user can select a different PRESET option (1-5). Press the LEFT or RIGHT ARROW button on the keypad to scroll through the PRESET options 1 - 5 (set up in UTILITY MENU/SET-UP/PRESET, page 24).

Preset Dispense

1. Wake up the metered dispense valve by pressing any button on the keypad (Fig. 1, page 7).
2. If ACTIVATE (A) is not highlighted, use the LEFT or RIGHT ARROW button on the keypad to highlight ACTIVATE (Fig. 31); then press the center, ENTER button on the keypad to select it.

The following screen (Fig. 32) displays after ACTIVATE is selected.

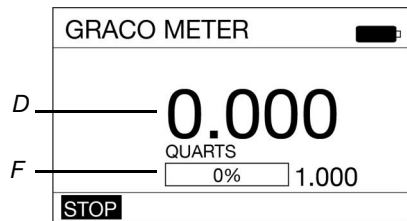

FIG. 32

3. Squeeze the trigger to dispense fluid. A numeric volume of dispensed fluid displays in field (D) and increases while the fluid is dispensed.
The progress bar (F) fills-in and a numeric percentage increases as the amount of fluid dispensed nears the Preset amount.
4. When the PRESET amount of fluid has been dispensed the trigger deactivates, stopping the fluid flow.

Preset Mode

- The screen shown in FIG. 33 displays. Notice the word “DONE” near the top of the screen, confirming the requested PRESET amount of fluid has been dispensed. The progress bar (F) now is entirely filled in and shows 100% of the fluid requested has been dispensed and the Dispensed Fluid Counter (D) now shows 1.000 matching the chosen PRESET parameters (K).

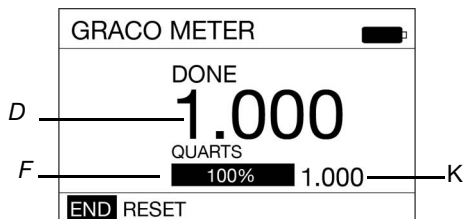

FIG. 33

- Use the LEFT ARROW on the keypad to highlight RESET. Press the ENTER button on the keypad to reset the meter to 0.000 to prepare it for the next dispense.
- Use the RIGHT ARROW on the keypad to highlight END. Press the center ENTER button on the keypad to return to the Main Menu Screen.

NOTE: If RESET was not selected after the dispense was completed, the amount of fluid dispensed in the last dispense will be shown in this field. If RESET was selected, the field will show 0.000.

STOP Function

During the dispense the word STOP (FIG. 32) is highlighted on the lower left corner of the dispense screen. To interrupt the dispense at any time during the fill:

- Release the trigger and press the center ENTER button on the key pad.

Notice the word “STOPPED” appears across the top of the display (FIG. 34).

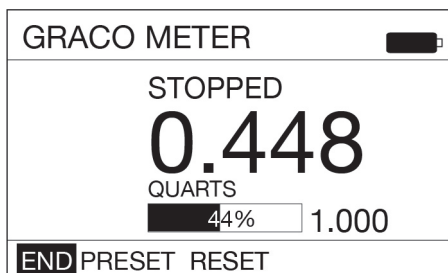

FIG. 34

- Use the LEFT or RIGHT ARROW button on the keypad to highlight either:
 - END - Ends the dispense and returns the meter to the MAIN MENU screen.
 - PRESET - Allows for increasing, decreasing or entirely changing the amount of fluid for the PRESET selection. The screen shown in FIG. 31 displays. See Function Command (C)/PRESET, page 18 for instructions on changing the PRESET).
 - RESET - Resets the Dispensed Fluid Counter (D) back to 0.000.
- After making changes use the LEFT ARROW button on the keypad to highlight END. Press the center ENTER button on the key pad to select END and return to the Dispense screen to complete the dispense.

TOTAL



FIG. 35

M LIFETIME TOTAL - Running, non-resettable total quantity fluid that has been dispensed over the life of the meter. The unit of measurement displayed is determined by the Unit of Measurement criteria selected in *UTILITY MENU/SET-UP/UNIT OF MEASURE*, page 23. When Pints, Quarts or Gallons is selected the Unit of Measurement will be shown as Gallons. When Liter is selected the Unit of Measurement will be shown as Liters.

N RESETTABLE TOTAL - Running total of the quantity of fluid dispensed through the meter since the previous total was reset. The unit of measurement displayed is determined by the Unit of Measurement criteria selected in *UTILITY MENU/SET-UP/UNIT OF MEASURE*, page 23.

GO BACK - Returns to Main Menu screen.

RESET - Resets the Resettable total.

UTILITY MENU

There are four Utility options available from the *UTILITY MENU* screen.

- **DEVICE INFORMATION**, page 21
- **RESET**, page 22
- **SET-UP SCREENS**, page 22
- **GO BACK**, page 27

To select a *UTILITY MENU*:

1. Use the UP or DOWN ARROW button to select the desired screen from the list.
2. When the screen is highlighted (Fig. 36), press the ENTER button on the key pad.

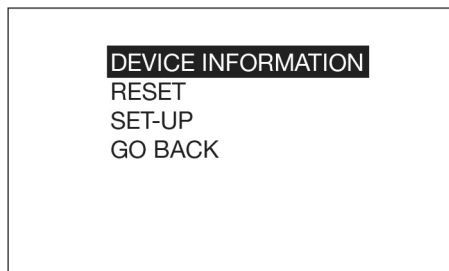

FIG. 36

DEVICE INFORMATION

The Device Information Screen is used for diagnostics only. An example of this screen is shown in Fig. 37.

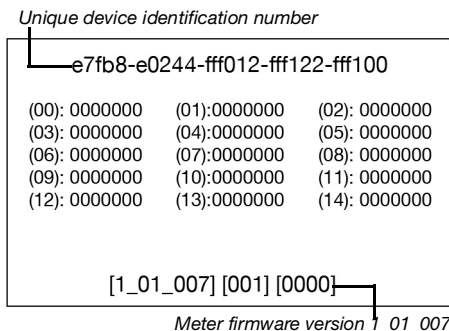

FIG. 37

Preset Mode

RESET

Restarts meter. After selecting RESET the screen display goes blank. After approximately 10 seconds the screens shown in FIG. 38- FIG. 40 display.

NOTE: The screen shown in FIG. 38 allows the user to upgrade for use with a Pulse FC system. See **Pulse FC Mode**, page 28 for instructions.

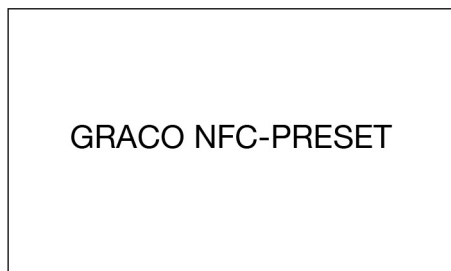

FIG. 38

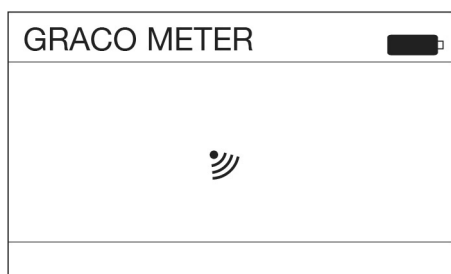

FIG. 39

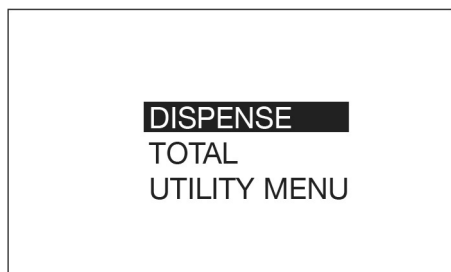

FIG. 40

When the MAIN MENU Screen shown in FIG. 40 displays, the meter is ready to use.

SET-UP SCREENS

The SET-UP Menu includes the following options: **UNIT OF MEASURE**, **BANNER**, **CALIBRATE** and "+++".

A second SET-UP screen is accessed by selecting the "+++".

This screen includes options for **LANGUAGE**, **PRESET**, **FLIP DISPLAY** and **LOCK SETTINGS**. This screen also includes a **GO BACK** option to return to the user to the **UTILITY MENU** screen.

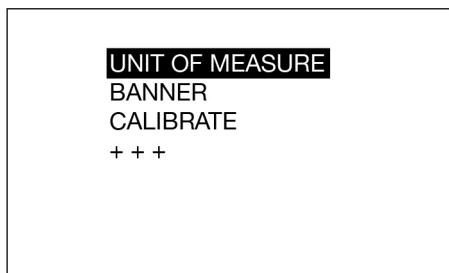

FIG. 41



1. Use the UP or DOWN ARROW button on the keypad to select one of the SET-UP options.
2. When the desired SET-UP option is highlighted, press the center ENTER button on the keypad

UNIT OF MEASURE

The meter is factory-set to quarts. The **UNIT OF MEASURE** screen configures the meter to dispense in PINTS, QUARTS, GALLONS OR LITERS. This screen also includes a GO BACK option to return to the Utility Menu screen.

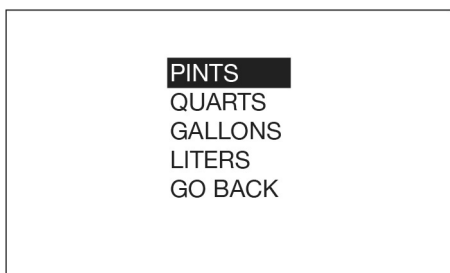

FIG. 42

1. Use the UP or DOWN ARROW button on the keypad to select the desired unit of measure from the displayed list: PINTS, QUARTS, GALLONS, LITERS or GO BACK.
2. When the desired unit of measure is highlighted, press the center ENTER button on the keypad.

BANNER

The banner screen is used to assign a name to the meter, such as Meter 1, Meter 2, etc. This is useful in shops that have more than one meter in their system.

Names can be made up of any combination of letters or numbers.

The maximum number of characters is 15.

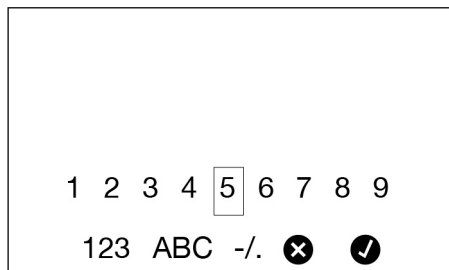

FIG. 43

1. Use the UP, DOWN, LEFT and RIGHT ARROW buttons on the keypad to select letters and numbers needed to name the meter.
2. Press the center ENTER button on the keypad after each desired letter or number is highlighted to select it.
3. When finished naming the meter, use the RIGHT ARROW button on the keypad to highlight the ✓ symbol. Press the center ENTER button on the keypad to return to the SET-UP Menu Screen.

NOTE: The **BANNER** created displays on the top left corner of the screen.

Preset Mode

CALIBRATE

Calibrating the metered dispense valve assures that dispenses are accurate. See Calibration instructions beginning on page 13.

“+++”

Indicates there are additional functions; **LANGUAGE**, **FLIP DISPLAY**, **LOCK SETTINGS** and **GO BACK** are available on the next screen.

LANGUAGE

The meter is factory-set to English. On the first language screen it can be configured to display in ENGLISH, FRENCH, GERMAN, ITALIAN, “+++”.

A second language screen is accessed by selecting the “+++”.

This screen includes language options of POLISH, PORTUGUESE, RUSSIAN AND SPANISH. This screen also includes a GO BACK option to return to the SET- UP Menu screen.



FIG. 44

1. Use the UP or DOWN ARROW button on the keypad to select the desired language from the displayed list: ENGLISH, FRENCH, GERMAN, ITALIAN, “+++”.

POLISH, PORTUGUESE, RUSSIAN, SPANISH or GO BACK

2. When the desired language is highlighted, press the center ENTER button.

PRESET

The metered dispense valve can be programmed to dispense 5 different preset amounts.

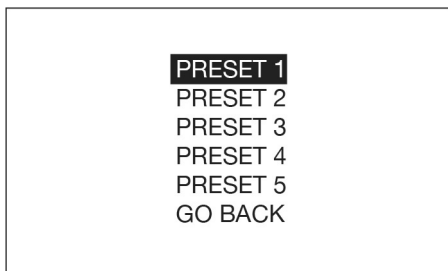

FIG. 45

1. Use the UP or DOWN ARROW button on the keypad to highlight the desired PRESET. Press the center ENTER button to select it.
2. The screen shown in Fig. 46 displays.

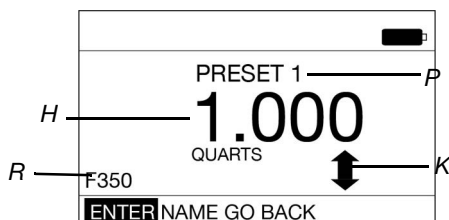

FIG. 46

PRESET SETUP SCREEN

- H PRESET AMOUNT DISPENSE VOLUME** - Shows the volume of fluid that the meter is currently set up to dispense. Press the UP and/or DOWN arrow on the keypad to increase and/or decrease this quantity. On the DISPENSE screen this amount is shown in field (G) (See FIG. 31, page 18).
- K INCREASE/DECREASE ARROW** - The up/down arrow on the screen indicates the user can increase or decrease the PRESET quantity before starting the dispense. Use the UP or DOWN ARROW button on the keypad to increase or decrease the PRESET amount.
- P PRESET TITLE** - Identifies which preset option is being set up. The example in FIG. 46 shows PRESET1. This means the PRESET parameters for PRESET1 in the list are being set.
- R NAME** - Additional information about the PRESET, such as the type of engine or vehicle make/model, fluid type, etc. The example shown in FIG. 46 shows F350 in the NAME field on the display for PRESET1.

Creating a PRESET

Be sure ENTER in the lower left corner of the display screen is highlighted (FIG. 46).

1. Use the UP AND DOWN ARROW on the keypad to increase or decrease the PRESET AMOUNT (H) (FIG. 46).
2. When finished setting the amount, press the center ENTER button on the keypad to save the PRESET.

To SET-UP a PRESET NAME:

1. Use the RIGHT ARROW on the keypad to highlight NAME (FIG. 46). Press the center ENTER button on the keypad to select NAME.
2. The screen shown in FIG. 47 displays. This screen can be used to create a unique description for the PRESET.

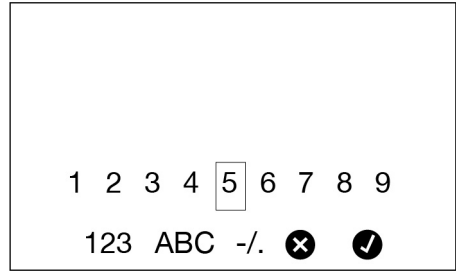

FIG. 47

3. Use the UP, DOWN, LEFT and RIGHT ARROW buttons on the keypad to select the letters and numbers needed to name the PRESET.
4. Press the center ENTER button on the keypad after each letter or number is highlighted to select it.
5. After naming the PRESET, use the RIGHT ARROW button on the keypad to highlight the ✓ symbol. Press the center ENTER button on the keypad to return to the PRESET Setup Screen.
6. ENTER in the lower left corner of the display should be highlighted. If there are no additional changes, press the center ENTER button on the keypad to save the PRESET and return to PRESET Menu Screen.

FLIP DISPLAY

Allows for viewing data on the metered dispense valve display upside down for oil bar installation. After selecting **FLIP DISPLAY**, the meter display goes blank for about 10 seconds. After approximately 10 seconds the screens shown in FIG. 48 - FIG. 50 display.

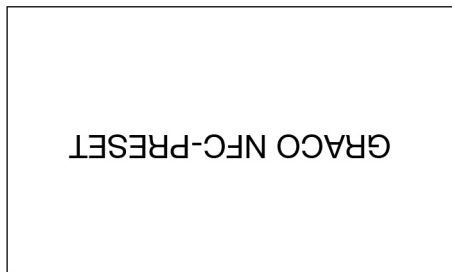

FIG. 48

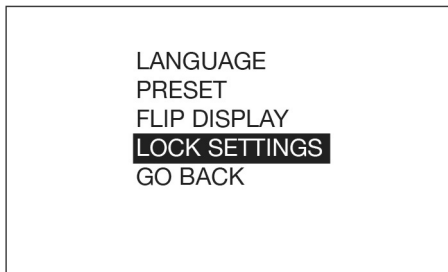

FIG. 51



FIG. 49



FIG. 50

When the MAIN MENU Screen shown in FIG. 50 displays, the meter is ready to use.

LOCK SETTINGS

Prevents unauthorized access to meter settings.

To lock the meter:

1. Use the DOWN ARROW button to select **LOCK SETTINGS** in the list.

To unlock the meter:

1. Use the DOWN ARROW button on the keypad to highlight **UTILITY MENU**.
2. Press the center ENTER button on the keypad to select it.

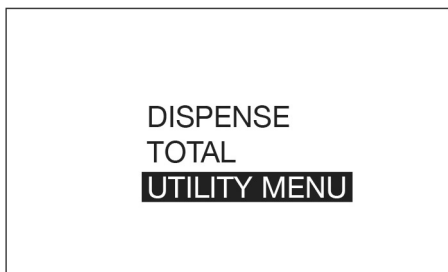

FIG. 52

3. The menu shown in FIG. 53 displays. Use the DOWN ARROW button to highlight RESET in the list.

NOTE: Do not press the center ENTER button after RESET is selected. Continue to step 4.

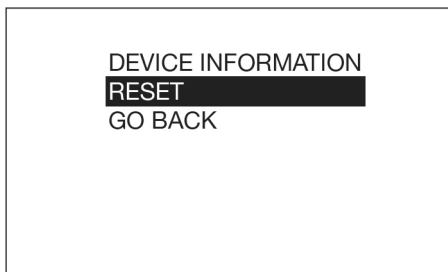

FIG. 53

4. Press and hold the LEFT ARROW button.
5. While still holding down the LEFT ARROW button, press the CENTER button.

DEVICE INFORMATION

See page 21 for a description of this screen.

RESET

See page 22 for a description of this screen.

GO BACK

Returns to the Main Menu Screen (FIG. 54).

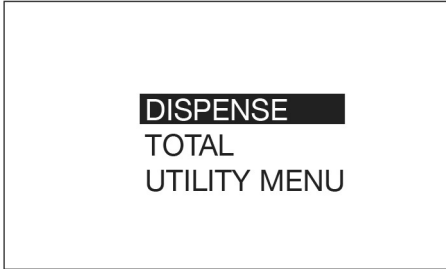

FIG. 54

Pulse FC Mode

Pulse FC Mode is only available with the purchase and installation of a Pulse FC Starter Kit (P/N 26C401). The kit contains everything needed to begin using Pulse FC with the meter, including a programmer and a software license.

Pulse FC uses NFC tags programmed to initiate different functions on the meter.

- Profile tags and fluid totalizer tags can program meter profiles and receive actual dispensed totalizer values from multiple meters.
- Fluid dispense vouchers and calibration vouchers can be used with only a single meter before they must be reprogrammed.

Tags may be purchased from Graco as packs of cards. When a tag or voucher is referenced in this manual, it refers to a card programmed to perform the designated function.

Enable Pulse FC Mode

1. Press the center ENTER button on the keypad to activate the meter, waking it from sleep mode. The screen shown in FIG. 55 displays.

NOTE: The screen in FIG. 55 only appears in Preset Mode the first time the meter is powered on. After the first power on, a meter in Preset Mode must be **RESET** to get to this screen. See **RESET** instructions, page 22.



FIG. 55

2. Touch the NFC fob to the indicator at the top of the bezel, as shown in FIG. 56, to send the NFC Code to the Pulse Fluid Management Software for authorization.

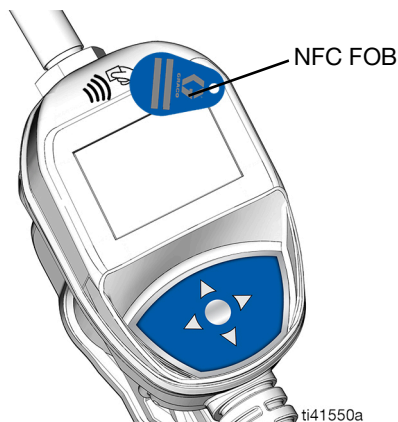

FIG. 56

3. When the profile tag is valid, a CONFIGURING (FIG. 57) message appears on the display.

NOTE: After the meter is placed in Pulse FC mode, it will only accept vouchers and tags configured by the same system used to make the profile tag.

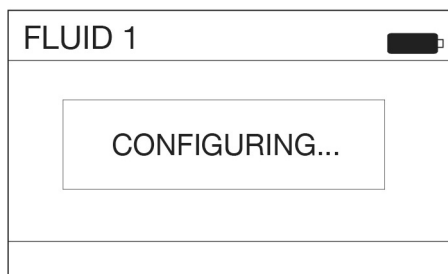

FIG. 57

4. After the meter has been successfully configured, the main menu screen shown in FIG. 58 displays.



FIG. 58

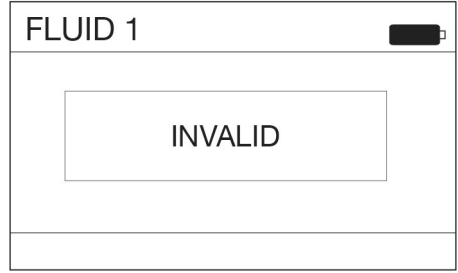

FIG. 60

Activation

1. Press the center ENTER button on the keypad to activate the meter. The screen shown in FIG. 55 displays.
2. Touch the NFC fob to the indicator at the top of the bezel, as shown in FIG. 59, to send the NFC Code to the Pulse Fluid Management Software for authorization.

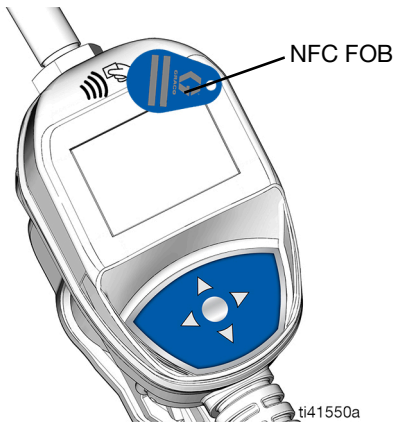

FIG. 59

3. If the Pulse Fluid Management Software does not recognize the NFC Code, the metered dispense valve will not authorize for a dispense and INVALID displays.

Calibration

NOTE:

- This calibration procedure requires a one (1) quart or one (1) liter clean, calibrated, volumetric flask. When the meter is configured to display fluid volume in pints, quarts, or gallons, the calibration procedure will require a one (1) quart calibrated, volumetric flask be used. When the meter is configured in liters, a one (1) liter volumetric flask is required for calibration.
- The metered dispense valve must be flushed and primed prior to calibration (see **Flushing**, page 11).
- A calibration voucher specifically configured for calibration is required.
- The metered dispense valve should be calibrated prior to first use. Calibrating the metered dispense valve assures that dispenses are accurate.

Calibration factors can vary due to fluid viscosity and flow rate.

Calibrate the metered dispense valve for specific fluids at nominal flow rates.

This calibration procedure requires a one (1) quart or one (1) liter calibrated, volumetric flask. If a one (1) quart or one (1) liter calibrated, volumetric flask is not available, see **Alternate Calibration** instructions, page 16.

Pulse FC Mode

To calibrate the metered dispense valve:

1. Activate the meter. See **Activation**, page 29.
2. If the meter recognizes the calibration voucher, the configuration screen shown in FIG. 61 displays.
3. The calibration k-factor screen shown in FIG. 61 displays. The number shown on the display is the k-factor the meter is currently using. After completing the calibration procedure this number may be the same or may be different than what is currently shown on the display.

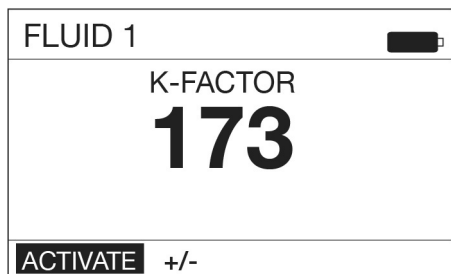

FIG. 61

4. Highlight **ACTIVATE** and press the center **ENTER** button on the keypad (FIG. 15).
- NOTE:** The +/- on this screen is used for Manual Calibration. See **Manual Calibration** instructions on page 31.
5. Dispense exactly one (1) quart or one (1) liter of fluid into a one (1) quart or one (1) liter clean, calibrated, volumetric flask.

NOTE: During calibration dispense the metered dispense valve will not display the volume dispensed. The volume dispensed is only determined by the flask measurement. The following screen displays during the calibration dispense.

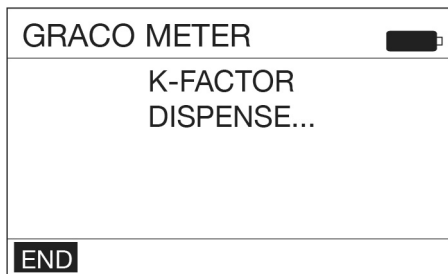

FIG. 62

6. When exactly one (1) quart or one (1) liter of fluid is dispensed into the flask use the center **ENTER** button on the keypad to select **END**. A screen displaying the quantity of fluid dispensed displays (FIG. 63 shows an example of the dispensed volume screen).

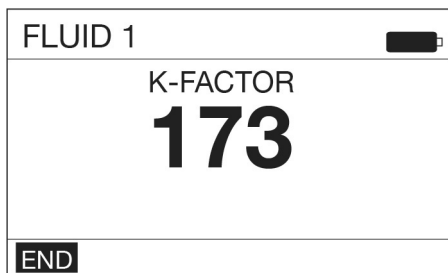

FIG. 63

7. Press the center **ENTER** button on the keypad to save the new calibration factor.
8. After selecting **END** the Main Menu screen displays.

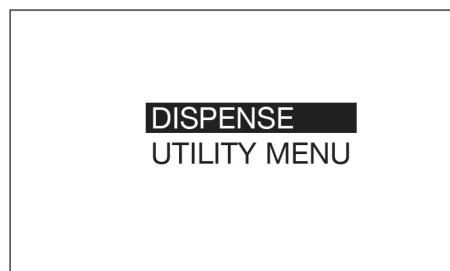

FIG. 64

Manual Calibration

NOTE: This Manual Calibration procedure is used when the k-factor is known and a simple adjustment of the displayed k-factor is needed.

1. Follow steps 1- 3 of the **Calibration** instructions (page 29).
2. Use the RIGHT ARROW button on the keypad to highlight +/- and press the center ENTER button on the keypad to select the +/- option (FIG. 65).

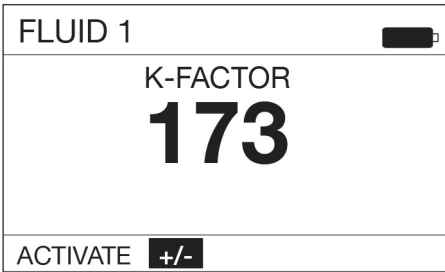

FIG. 65

3. The k-factor adjustment screen shown in FIG. 66 displays.

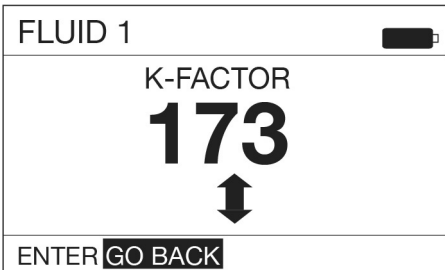

FIG. 66

4. Use the UP and DOWN ARROW to increase or decrease the displayed k-factor until the new k-factor displays on the screen.

NOTE: Selecting the GO BACK Function on this screen returns the display to the previous screen (shown in FIG. 65).

5. After adjustments to the k-factor are complete, ENTER should be highlighted in the lower left corner of the display as shown in FIG. 67. Press the center ENTER button on the keypad to select ENTER and save the new calibration factor.

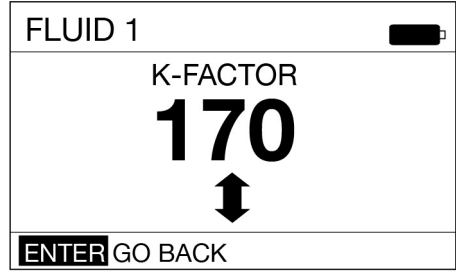

FIG. 67

After selecting ENTER the Main Menu screen shown in FIG. 68 displays.

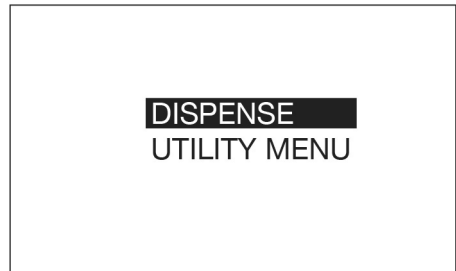

FIG. 68

Pulse FC Mode

DISPENSE

Screen Identification

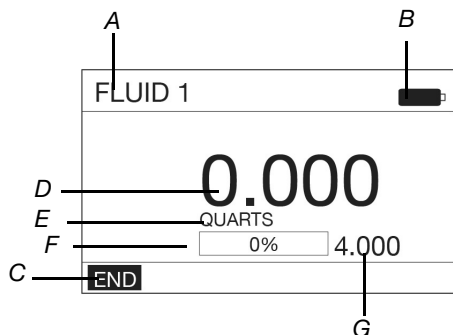

Fig. 69

- A BANNER** - Name of the fluid assigned to the meter in Pulse FC. This can only be set up by a Pulse FC profile tag.
- B BATTERY INDICATOR** - When the batteries are fully charged, the battery is completely filled in. As the battery discharges, the amount of battery that is filled-in declines.
- C FUNCTION COMMAND** - Function command options appear at the bottom of the display when applicable to the task being performed. END is the only Dispense screen option.
- D DISPENSED FLUID COUNTER**- As fluid is dispensed, this number increases to reflect the quantity of fluid that is being dispensed.
- E UNIT OF MEASURE** - Pints, Quarts, Gallons or Liters. Can only be set up by a Pulse FC profile tag.
- F PROGRESS BAR** - Graphic representation of the progression of the dispense shown by gradually filling-in the empty space in the bar. A textual representation of the progress is also shown in a percentage format.
- G PRESET AMOUNT** - The volume of fluid that the meter is currently authorized to dispense. The value set by a Pulse FC fluid voucher.

To dispense fluid:

1. Activate the meter. See **Activation**, page 29.
2. If the meter recognizes the fluid voucher, the DISPENSE screen shown in FIG. 70 displays.

NOTE: All dispense parameters are set including the unit of measurement and the total amount of fluid that can be dispensed. Adjustments cannot be made to these parameters.

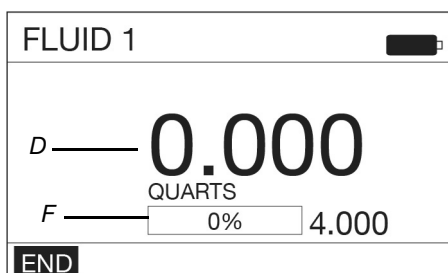

Fig. 70

3. Squeeze the trigger to begin dispensing fluid. A numeric volume of dispensed fluid displays in field (D) and increases while the fluid is dispensed.

The progress bar (F) fills-in and a numeric percentage increases as the amount of fluid dispensed nears the Preset amount.
4. When the PRESET amount of fluid has been dispensed the trigger deactivates, stopping the fluid flow.
5. END is highlighted. Press the center ENTER button on the key pad to end the dispense. The Main Menu screen displays.

END Function

During the dispense the word END (FIG. 70) is highlighted on the lower left corner of the dispense screen. To interrupt the fill during dispensing:

1. Release the trigger and press the center ENTER button on the key pad to select END.
2. The dispense ends and immediately returns the meter to the MAIN MENU screen. The dispense is complete.

NOTE: In Pulse FC Mode fluid is dispensed to finish an interrupted dispense.

UTILITY MENU

There are three Utility options available from the UTILITY MENU screen.

- **DEVICE INFORMATION**, page 33
- **FLIP DISPLAY**, page 34
- **GO BACK**, page 34

To select a UTILITY MENU:

1. Activate the meter. No voucher or tag is required to access the menu. See **Activation**, page 29.
2. Press the center ENTER button on the keypad a second time to bypass the screen in FIG. 55. The Main Menu screen shown in FIG. 71 displays.



FIG. 71

3. If UTILITY MENU is not highlighted, use the DOWN ARROW on the key pad to highlight it.

4. Press the center ENTER button on the key pad to select UTILITY MENU.
5. The UTILITY MENU screen shown in FIG. 72 displays.



FIG. 72

6. Use the UP or DOWN ARROW button to select the desired screen from the list.
7. When the screen is highlighted, press the ENTER button on the key pad.

DEVICE INFORMATION

The Device Information Screen is used for diagnostics only. An example of this screen is shown in FIG. 73.

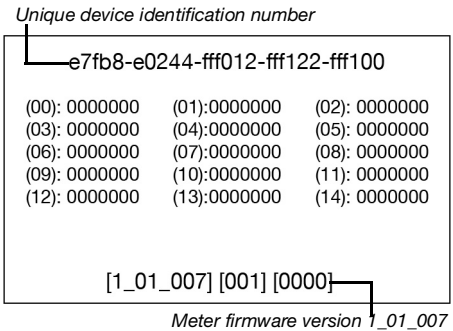

FIG. 73

Pulse FC Mode

FLIP DISPLAY

Allows the data to be viewed on the metered dispense valve display upside down for oil bar installation. After selecting FLIP DISPLAY, the meter display goes blank for about 10 seconds. After approximately 10 seconds the screens shown in FIG. 74 - FIG. 75 display.

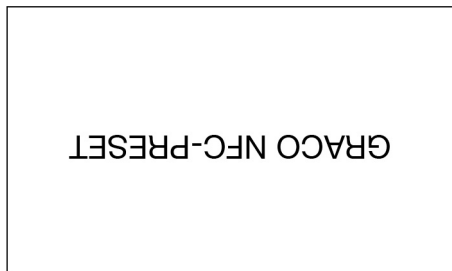

FIG. 74



FIG. 75

When the MAIN MENU Screen shown in FIG. 75 displays, the meter is ready to use.

GO BACK

Returns to the Main Menu Screen (FIG. 76).



FIG. 76

Service

Battery Replacement

- Replace batteries with four AA, alkaline batteries.
- Be sure to follow the correct polarity as shown on the installation labels located on either side of the metered dispense valve when installing batteries in the battery compartment (FIG. 78).
- Do not mix different types of batteries together or old batteries with fresh ones. Always replace all 4 batteries with 4, fresh, new AA batteries.

To change the battery:

1. Remove screws (36) from the battery compartment cover (5).
2. Use a small, flat screwdriver to gently pry the cover away from the metered dispense valve housing on the bottom side of the cover, near the extension attachment as shown in FIG. 77.

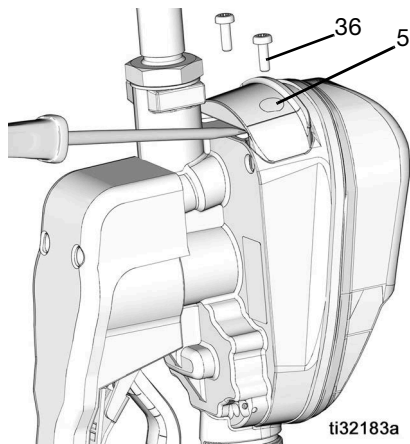

FIG. 77

3. Remove and separately recycle batteries according to all applicable regulations. Do not dispose of with household or commercial waste.

4. Install 4 new batteries. See labels on the each side of the housing and FIG. 78 for battery orientation.

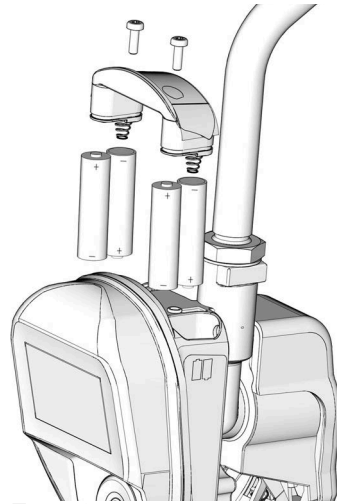

FIG. 78

5. Replace cover (5) and screws (36). Tighten screws securely (FIG. 79).

NOTE: Do not over-tighten the screws.

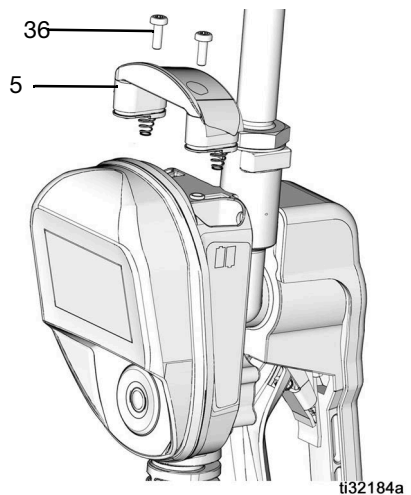

FIG. 79

Troubleshooting



1. **Perform pressure relief procedure**, page 10, before checking or repairing the metered dispense valve.
2. Verify that the pump, other valves, and controls are operating properly.

Problem	Cause	Solution
Battery dead icon is present.	Batteries are low.	Replace batteries, page 35.
Display does not activate	Batteries are dead.	Replace batteries, page 35.
	Electronic control is malfunctioning.	Replace the electronic bezel assembly. Contact your Graco distributor for assistance ordering this part.
Slow or no fluid flow	Filter is clogged.	Relieve pressure , page 10. Clean or replace filter. If the problem remains, contact your Graco distributor for repair or replacement.
	Pump pressure is low.	Increase pump pressure.
	Twist lock nozzle not fully open.	Aim nozzle into bucket or rag. Fully open nozzle. Do not trigger metered dispense valve when nozzle is closed. If you do accidentally trigger the metered dispense valve with the nozzle closed, point nozzle into a waste bucket and open the nozzle to relieve pressure and expel built up fluid.
	Shut-off valve is not fully open.	Fully open shut-off valve.
	Foreign material is jammed in the metered dispense valve housing.	Contact your Graco distributor for repair or replacement.
Displayed dispensed amount is not accurate	Unit needs to be calibrated for the fluid that is being dispensed.	Calibrate the metered dispense valve for the fluid that is being dispensed.
Metered dispense valve leaks from cover/control	Poor seal at metering cover chamber.	Contact your Graco distributor for repair or replacement.

Problem	Cause	Solution
Metered dispense valve leaks from the nozzle when the nozzle is left in the closed position.	Nozzle has a damaged seal.	Replace nozzle. See Install the Nozzle , page 12.
<p>Metered dispense valve leaks from the nozzle when the nozzle is left in the open position.</p> <p>It is important to distinguish between the two states of the nozzle to determine the cause of this problem. a new nozzle in the open state will NOT correct a fluid leak caused by a faulty valve.</p>	Metered dispense valve with MANUAL nozzle should be closed after each use.	Close MANUAL nozzle when meter is not in use.
	Metered dispense valve with AUTOMATIC nozzle left open exasperated by thermal expansion inside the meter.	Close nozzles when meters are not in use. Wipe nozzle tip after each use.
	Valve cartridge has damaged seals.	Close nozzles when meters are not in use. Wipe nozzle tip after each use. Replace valve cartridge. Replacement Kit Part 25D904.
Metered dispense valve leaks from swivel	Poor swivel/hose connection.	Apply PTFE tape (leave a minimum of two engaged threads uncovered for electrical continuity) or sealant to threads of hose and tighten the connection.
	Poor swivel/metered dispense valve housing connection.	Torque the fitting to 20-25 ft.-lb (27.12 - 34 N•m).
	Swivel seals have deteriorated and leak.	Replace swivel. Use Swivel Seal and Filter Replacement Kit 25D906. See Pulse Metered Dispense Valve Repair manual.
Unit does not stop dispensing when assumed preset amount is dispensed.	Valve is dirty or seals are defective.	Replace valve cartridge. Replacement Kit part 25D904.
	Low battery.	Replace batteries, page 35.
	Solenoid not functioning	Replace solenoid.
Screen locks up or freezes	Firmware Issue	Remove batteries. Wait five minutes, then replace batteries and restart.

Fault Codes

Fault codes are listed below. Even in a fault condition the unit keeps track of the amount dispensed. Whenever a fault code is displayed, you must end the dispense.

Fault Code	Cause	Solution
Fault 2	Reed Switch Fault: Fault occurred with pick-up in internal gear.	Ensure that the flow rate is not higher than 18 gpm (68 lpm). For further assistance, contact your Graco distributor.
	Reed switch malfunction.	Replace electronic bezel housing.
	Unit was dropped or unit encountered excessive vibration during shipping.	End dispense
	Air in fluid line.	Fix leaks in pump suction line.
	Excessive pulsation.	Re-plump sump suction line to a larger size.
Fault 4	Flow has continued after it should have shut off.	End dispense
	Flow has occurred in lockout condition.	

Parts

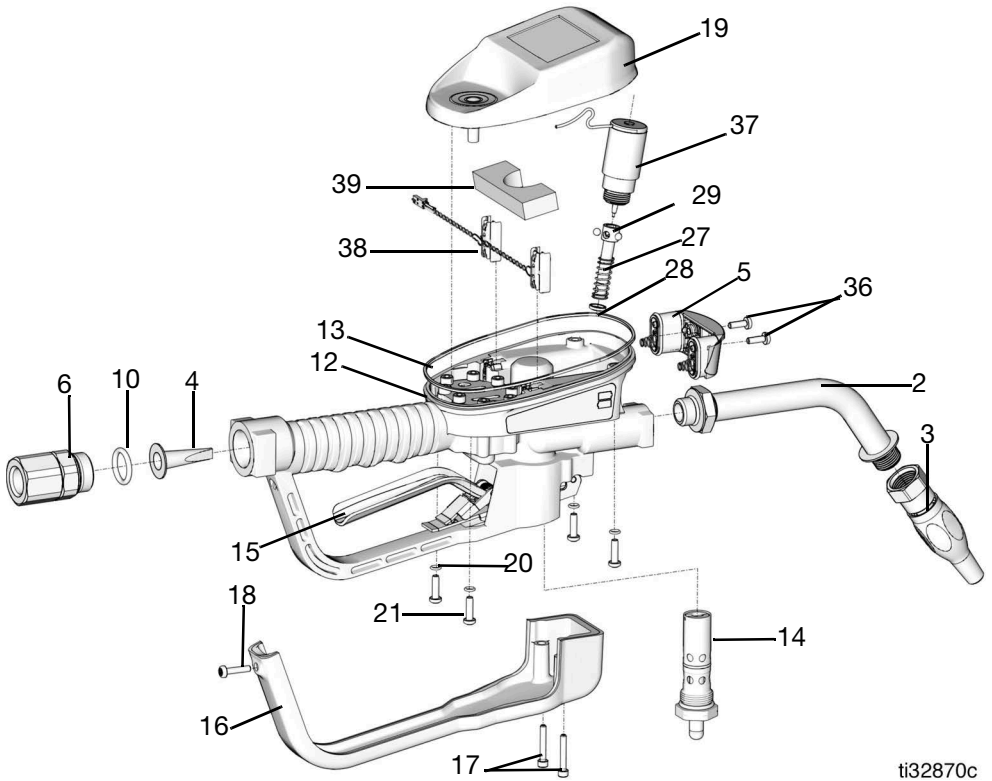

ti32870c

FIG. 80

Parts

Ref	Part	Description	Qty
1	----	VALVE, metered dispense valve (see models page X)	1
2	----	EXTENSION	
	16Y863	<i>Flex</i>	
	255194	<i>Rigid</i>	1
	255854	<i>Gear Lube</i>	
	273079	<i>Windshield washer solvent</i>	
3	----	NOZZLE	
	17R220	<i>Automatic, quick close</i>	1
	17T207	<i>Manual Antifreeze</i>	
	255461	<i>High Flow</i>	
	255470	<i>Gear Lube/ATF</i>	
4★		STRAINER, mesh	1
5 †	25M593	COVER, battery	1
6		SWIVEL, straight	
	247344	<i>1/2 in. npt</i>	1
	247345	<i>3/4 in. npt</i>	
	24H097	<i>1/2 - 14 bspt</i>	
	24H098	<i>1/2- 14 bspp</i>	
	24H099	<i>3/4 - 14 bspt</i>	
	24H100	<i>3/4 - 14 bspp</i>	
10★	155332	PACKING, o-ring	1
12	----	HOUSING, metered dispense valve	1
13	131258	PACKING, square ring	1
14	25D904	VALVE, metered dispense valve, assy	1
15	25M601		1
16	129830	COVER, trigger guard	1
17	16E337	SCREW, cap, sch, sst	2
18	131256	SCREW, mach, torx pan hd	1
19	26C403	KIT, BEZEL, electrical	1
20	131257	PACKING, o-ring	4
21	25N342	SCREW, mach, torx pan hd	4
27◆	----	ROD, trip	1
28◆	129623	SEAL, molded	1
29◆	----	BALL, 5 mm	3
33	121413	BATTERY, pkg, 4 ct, alkaline AA (not shown)	1
36 †	112380	SCREW, mach, pan hd	2
37	26C276	SOLENOID	1
38*		Power Cable	1
39*		Foam	1

Related Kits

Ref	Part	Description
◆	25D903	KIT, Trip Rod Repair, includes 27, 28, 29
†	25D907	KIT, Battery Cover, includes 5 and 36
✱	25P665	Kit, Power Cable, includes 38 and 39 For oil and ATF applications order Kit 25D906 (Includes 80 mesh strainer (4) and swivel o-ring (10)) ★ For anti-freeze applications order Kit 25U000 (Includes 200 mesh strainer (4) and swivel o-ring (10))

Technical Specifications

Metered Dispense Valve		
	US	Metric
Flow range*	0.25 to 18 gpm	0.9 to 68 lpm
<i>*Tested in 10W motor oil. Flow rates vary with fluid pressure, temperature and viscosity.</i>		
Maximum Working Pressure	1500 psi	10.34 MPa, 103.4 bar
Units of Measure (factory set to quarts)	pints, quarts, gallons	liters
Weight	5.3 pounds	2.4 kg
Dimensions (without extension)		
Length	13 inches	33 cm
Width	3.75 inches	9.5 cm
Height	5.75 inches	14.6 cm
Units of measure (factory set in quarts)	maximum recorded dispensed volume = 9999 units maximum preset volume = 9999 units	
Inlet	1/2-14 npt or 3/4-14 npt	
Outlet	3/4-16 straight thread o-ring boss	
Operating temperature range	4°F to 158°F	-16°C to 70°C
Storage temperature range	-40°F to 158°F	-40°C to 70°C
Battery**	4AA alkaline batteries	
**Recommended Battery: Energizer® Alkaline E91.		
NFC Frequency Band	13.56 Mhz	
Maximum NFC Transmit Power	1 mW (0 dBm)	
Wetted parts	aluminum, stainless steel, PBT, nitrile rubber, zinc plated carbon steel, nickel plated carbon steel	
Fluid compatibility	antifreeze, gear oil, crankcase oil, ATF	
Metered Dispense Valve Accuracy†	+/- 0.5 percent	
† At 2.5 gpm (9.5 lpm), at 70°F (21°C), with 10-weight oil and one gallon dispensed. May require calibration.		

California Proposition 65

CALIFORNIA RESIDENTS

 **WARNING:** Cancer and reproductive harm – www.P65warnings.ca.gov.

FCC / IC Notice

Contains FCC ID: JHI-SDPMETER

Contains IC: 4840A-SDPMETER

The enclosed device complies with Part 15 of the FCC Rules and with Industry Canada license-exempt RSS standard(s). Operation is subject to the following two conditions:(1) this device may not cause harmful interference and (2) this device must accept any interference received, including interference that may cause undesired operation.

Le présent appareil est conforme aux CNR d'Industrie Canada applicables aux appareils radio exempts de licence. L'exploitation est autorisée aux deux conditions suivantes: (1) l'appareil ne doit pas produire de brouillage, et (2) l'utilisateur de l'appareil doit accepter tout brouillage radioélectrique subi, même si le brouillage est susceptible d'en compromettre le fonctionnement.

Changes or modifications not expressly approved by the party responsible for compliance could void the user's authority to operate the equipment.

All written and visual data contained in this document reflects the latest product information available at the time of publication. Graco reserves the right to make changes at any time without notice.

Original instructions. This manual contains English. MM 3A6673

Graco Headquarters: Minneapolis
International Offices: Belgium, China, Japan, Korea

GRACO INC. AND SUBSIDIARIES • P.O. BOX 1441 • MINNEAPOLIS MN 55440-1441 • USA

Copyright 2019, Graco Inc. All Graco manufacturing locations are registered to ISO 9001.
www.graco.com, Revision H, October 2023

Graco 5-Year Meter and Valve Warranty

Graco 5-Year Meter and Valve Warranty

Graco warrants all equipment referenced in this document which is manufactured by Graco and bearing its name to be free from defects in material and workmanship on the date of sale to the original purchaser for use. With the exception of any special, extended, or limited warranty published by Graco, Graco will, for a period from the date of sale as defined in the table below, repair or replace equipment covered by this warranty and determined by Graco to be defective. This warranty applies only when the equipment is installed, operated and maintained in accordance with Graco's written recommendations.

Graco 5-Year Meter and Valve Extended Warranty	
Components	Warranty Period
Structural Components	5 years
Electronics	3 years
Wear Parts - including but not limited to o-rings, seals and valves	1 year

This warranty does not cover, and Graco shall not be liable for general wear and tear, or any malfunction, damage or wear caused by faulty installation, misapplication, abrasion, corrosion, inadequate or improper maintenance, negligence, accident, tampering, or substitution of non-Graco component parts. Nor shall Graco be liable for malfunction, damage or wear caused by the incompatibility of Graco equipment with structures, accessories, equipment or materials not supplied by Graco, or the improper design, manufacture, installation, operation or maintenance of structures, accessories, equipment or materials not supplied by Graco.

This warranty is conditioned upon the prepaid return of the equipment claimed to be defective to an authorized Graco distributor for verification of the claimed defect. If the claimed defect is verified, Graco will repair or replace free of charge any defective parts. The equipment will be returned to the original purchaser transportation prepaid. If inspection of the equipment does not disclose any defect in material or workmanship, repairs will be made at a reasonable charge, which charges may include the costs of parts, labor, and transportation.

THIS WARRANTY IS EXCLUSIVE, AND IS IN LIEU OF ANY OTHER WARRANTIES, EXPRESS OR IMPLIED, INCLUDING BUT NOT LIMITED TO WARRANTY OF MERCHANTABILITY OR WARRANTY OF FITNESS FOR A PARTICULAR PURPOSE.

Graco's sole obligation and buyer's sole remedy for any breach of warranty shall be as set forth above. The buyer agrees that no other remedy (including, but not limited to, incidental or consequential damages for lost profits, lost sales, injury to person or property, or any other incidental or consequential loss) shall be available. Any action for breach of warranty must be brought within one (1) year past the warranty period, or two (2) years for all other parts.

GRACO MAKES NO WARRANTY, AND DISCLAIMS ALL IMPLIED WARRANTIES OF MERCHANTABILITY AND FITNESS FOR A PARTICULAR PURPOSE, IN CONNECTION WITH ACCESSORIES, EQUIPMENT, MATERIALS OR COMPONENTS SOLD BUT NOT MANUFACTURED BY GRACO. These items sold, but not manufactured by Graco (such as electric motors, switches, hose, etc.), are subject to the warranty, if any, of their manufacturer. Graco will provide purchaser with reasonable assistance in making any claim for breach of these warranties.

In no event will Graco be liable for indirect, incidental, special or consequential damages resulting from Graco supplying equipment hereunder, or the furnishing, performance, or use of any products or other goods sold hereto, whether due to a breach of contract, breach of warranty, the negligence of Graco, or otherwise.

FOR GRACO CANADA CUSTOMERS

The Parties acknowledge that they have required that the present document, as well as all documents, notices and legal proceedings entered into, given or instituted pursuant hereto or relating directly or indirectly hereto, be drawn up in English. Les parties reconnaissent avoir convenu que la rédaction du présente document sera en Anglais, ainsi que tous documents, avis et procédures judiciaires exécutés, donnés ou intentés, à la suite de ou en rapport, directement ou indirectement, avec les procédures concernées.

Graco Information

For the latest information about Graco products, visit www.graco.com.
For patent information, see www.graco.com/patents.

TO PLACE AN ORDER, contact your Graco distributor or call to identify the nearest distributor.

Phone: 612-623-6928 **or Toll Free:** 1-800-533-9655, **Fax:** 612-378-3590

All written and visual data contained in this document reflects the latest product information available at the time of publication. Graco reserves the right to make changes at any time without notice.

Original instructions. This manual contains English. MM 3A6673

Graco Headquarters: Minneapolis
International Offices: Belgium, China, Japan, Korea

GRACO INC. AND SUBSIDIARIES • P.O. BOX 1441 • MINNEAPOLIS MN 55440-1441 • USA

Copyright 2019, Graco Inc. All Graco manufacturing locations are registered to ISO 9001.
www.graco.com, Revision H, October 2023