

Installation



UniXact[®] Automated Jet Dispense System

3A5913B

Diaphragm-Jet[™] Technology

EN

For non-contact dispensing of viscous or hot melt material in industrial environments.
Not for use in explosive atmospheres or hazardous (classified) locations.

For professional use only.

Models: B300 and B300-HM

See page 3 for model information.



Important Safety Instructions

Read all warnings and instructions in this manual and all related manuals before using this equipment. Save these instructions.

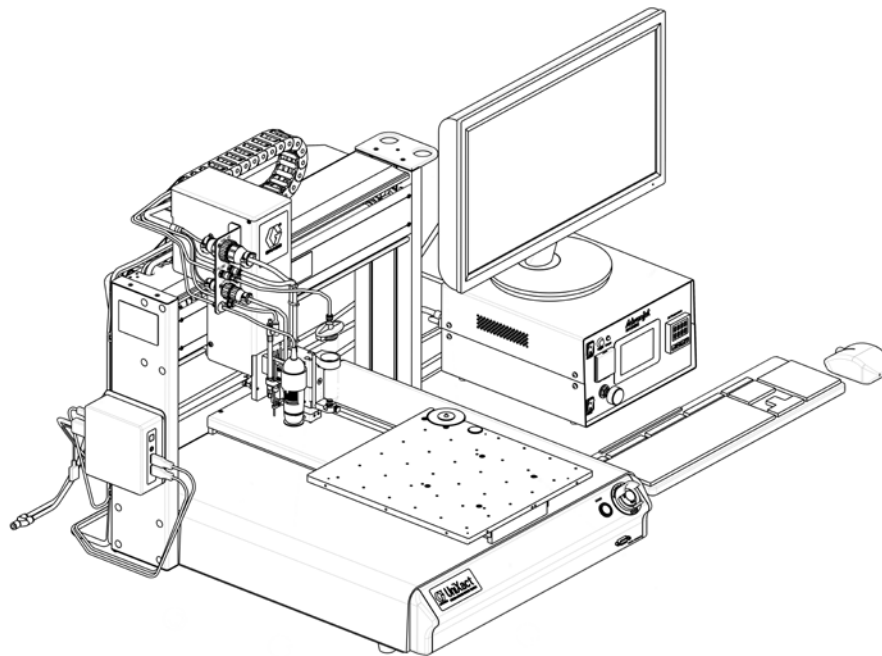

Table of Contents

| | |
|--|-----------|
| Related Manuals | 3 |
| Models | 3 |
| Warnings | 4 |
| 1. Technical Specifications | 6 |
| 2. UniXact Automated Jet Dispense System Features | 7 |
| 3. Setup and Connections | 8 |
| 3.1 Installation Requirements | 8 |
| 3.2 Setup Overview | 8 |
| 3.3 Remove Shipping Brackets..... | 9 |
| 3.4 Attach the PC..... | 9 |
| 3.5 Connect Cables and Air Lines | 10 |
| 3.6 Connect PC and Peripherals | 11 |
| 3.7 Mount the Jet..... | 11 |
| 3.8 Connect Jet Cables to Robot Z Head | 12 |
| 3.9 Connect Components to Power..... | 12 |
| 4. Power and Test Components | 13 |
| 4.1 Turn On Power to System Components | 13 |
| 4.2 Test Pneumatic Connections | 13 |
| 4.3 Test Communication and I/O Connections | 14 |
| 4.4 Test Emergency Stop | 15 |
| 4.5 Turn Off Power to System Components | 16 |
| Graco Standard Warranty | 18 |

Related Manuals

Manuals are available at www.graco.com. Component manuals below are in English:

| | |
|--------|---|
| 3A6244 | HV-2100 Jet Setup and Operation |
| 3A6226 | HV-2100C Jet Controller Setup and Operation |
| 3A6327 | HM-2600 Jet Setup and Operation |
| 3A6166 | HM-2600C Jet Controller Setup and Operation |
| 3A5937 | Jet Dispensing Parameters Supplement |
| 3A5914 | UniXact® Automated Jet Dispense System Software |
| 3A6674 | UniXact® Automated Jet Dispense System Parts |







Models

| Model | Part No. | Description |
|---------|----------|--|
| B300 | 25B350 | System, B300, HV-2100, 30 cc |
| | 25B351 | System, B300, HV-2100, 30 cc, heated feed tube |
| | 25B352 | System, B300, HV-2100, 6 oz., heated feed tube |
| B300-HM | 25B353 | System, B300-HM, HM-2600, 30 cc |

Note: B300 is used in this manual to represent both the B300 and B300 HM.

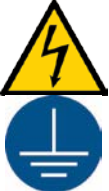
Warnings

The following warnings are for the setup, use, grounding, maintenance, and repair of this equipment. The exclamation point symbol alerts you to a general warning and the hazard symbols refer to procedure-specific risks. When these symbols appear in the body of this manual or on warning labels, refer back to these Warnings. Product-specific hazard symbols and warnings not covered in this section may appear throughout the body of this manual where applicable.

|  WARNING | |
|--|---|
|  | <p>MOVING PARTS HAZARD Moving parts can pinch, cut or amputate fingers and other body parts.</p> <ul style="list-style-type: none"> ▪ Keep clear of moving parts. ▪ Do not operate equipment with protective guards or covers removed. ▪ Equipment can start without warning. Before checking, moving, or servicing equipment, disconnect all power sources. ▪ Do not load or unload parts or material while the robot is running. ▪ Do not change fixtures or tooling while the robot power is on. |
|  | <p>ELECTRIC SHOCK HAZARD This equipment must be grounded. Improper grounding, setup, or usage of the system can cause electric shock.</p> <ul style="list-style-type: none"> ▪ Turn off and disconnect power cord before servicing equipment. ▪ Connect only to grounded electrical outlets. ▪ Use only 3-wire extension cords. ▪ Ensure ground prongs are intact on power and extension cords. |
|  | <p>TOXIC FLUID OR FUMES HAZARD Toxic fluids or fumes can cause serious injury or death if splashed in the eyes or on skin, inhaled, or swallowed.</p> <ul style="list-style-type: none"> ▪ Read Safety Data Sheets (SDSs) to know the specific hazards of the fluids you are using. ▪ Store hazardous fluid in approved containers and dispose of it according to applicable guidelines. |
|  | <p>BURN HAZARD Equipment surfaces and fluid that is heated can become very hot during operation. To avoid severe burns: Do not touch hot fluid or equipment.</p> |
|  | <p>PERSONAL PROTECTIVE EQUIPMENT Wear appropriate protective equipment when in the work area to help prevent serious injury, including eye injury, hearing loss, inhalation of toxic fumes, and burns. Protective equipment includes but is not limited to:</p> <ul style="list-style-type: none"> ▪ Protective eyewear, and hearing protection. ▪ Respirators, protective clothing, and gloves as recommended by the fluid and solvent manufacturer. |

Warnings, continued

WARNING



EQUIPMENT MISUSE HAZARD

Misuse can cause death or serious injury.

- Do not operate the unit when fatigued or under the influence of drugs or alcohol.
- Do not exceed the maximum working pressure or temperature rating of the lowest rated system component. See Technical Specifications in all equipment manuals.
- Use fluids and solvents that are compatible with equipment wetted parts. See Technical Specifications in all equipment manuals. Read fluid and solvent manufacturer's warnings. For complete information about your material, request Safety Data Sheets (SDSs) from distributor or retailer.
- Check equipment daily. Repair or replace worn or damaged parts immediately with genuine manufacturer's replacement parts only.
- Do not alter or modify equipment. Alterations or modifications may void agency approvals and create safety hazards.
- Make sure all equipment is rated and approved for the environment in which it is used.
- Use equipment only for its intended purpose. Contact your distributor for information.
- Route hoses and cables away from traffic areas, sharp edges, moving parts, and hot surfaces.
- Do not kink or over bend hoses or use hoses to pull equipment.
- Keep children and animals away from work area.
- Comply with all applicable safety regulations.

1. Technical Specifications

For the Advanjet Jet and Controller Specifications,
see the Related Manuals corresponding to the Models listed on page 3.

| UniXact[®] Tabletop Robot | |
|---|---------------------------------------|
| Dimensions (W x H x D) | 590 x 600 x 610 mm (23 x 24 x 24 in.) |
| Maximum Work Area (X / Y / Z) | 320 / 350 / 100 mm (13 / 14 / 4 in.) |
| Maximum Speed (XY / Z) | 200 / 100 mm/s (8 / 4 in/sec) |
| Repeatability | +/- 0.01 mm/axis |
| Interpolation | 2 Axis |
| DispensePro™ Software | Included |
| High-Precision Camera | Included |
| Integrated Prime/Purge | Included |
| Tip Detection | Included |
| Workpiece Detection | Mechanical or Laser |
| Data Storage | PC Storage/USB |
| I/O Signal Port | 8 Inputs / 8 Outputs |
| Control Method | PTP and CP |
| Power Requirements | AC 100-240V, 200W |
| Operating Temperature | 0 – 40 °C (0 – 104 °F) |
| Operating Humidity | 20 – 90% no condensation |
| Operating Noise Sound pressure measured 1.5 m (4.9 ft) from applicator at 40 psi (225 kPa), per EN ISO 3746 | 79.4 dB(A) |
| Unit Weight | 40 kg (88 lbs.) |

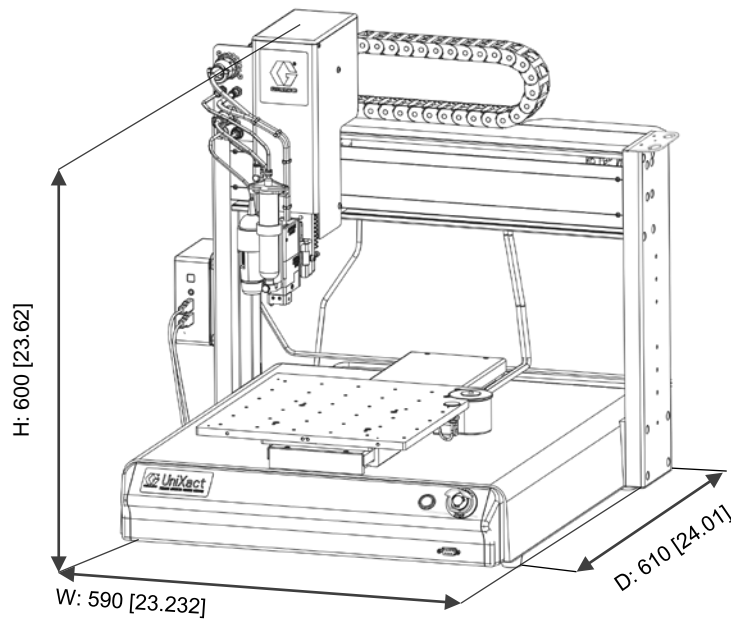

**Figure 1: UniXact[®] Tabletop Robot Dimensions;
Dimensions in millimeters [inches]**

2. UniXact Automated Jet Dispense System Features

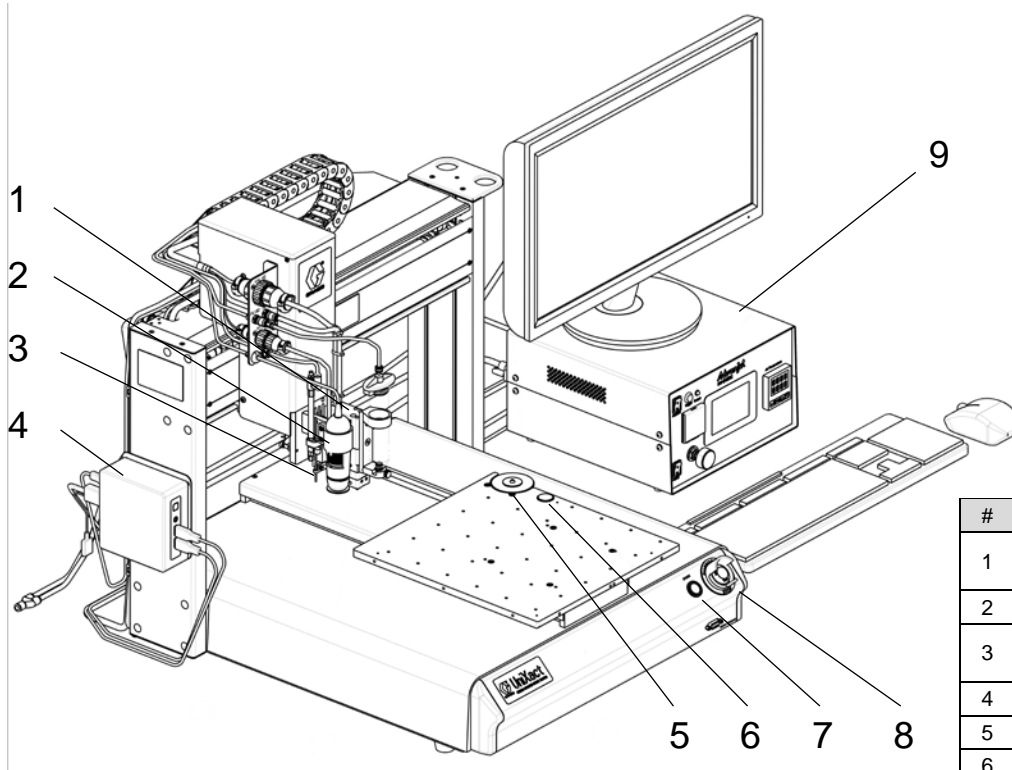

Figure 3: UniXact Automated Jet Dispense System Model 25B350 with Advanjet® HV-2100 Jet

| # | ITEM |
|----|---|
| 1 | ADVANJET® HV-2100 JET VALVE |
| 2 | CAMERA |
| 3 | MECHANICAL HEIGHT SENSOR |
| 4 | PC |
| 5 | PRIME/PURGE STATION |
| 6 | TACTILE SWITCH |
| 7 | LIGHTED START BUTTON |
| 8 | EMERGENCY STOP BUTTON |
| 9 | ADVANJET® HV-2100C JET CONTROLLER |
| 10 | ADVANJET® HM-2600C HOTMELT JET CONTROLLER |
| 11 | ADVANJET® HM-2600 HOTMELT JET VALVE |

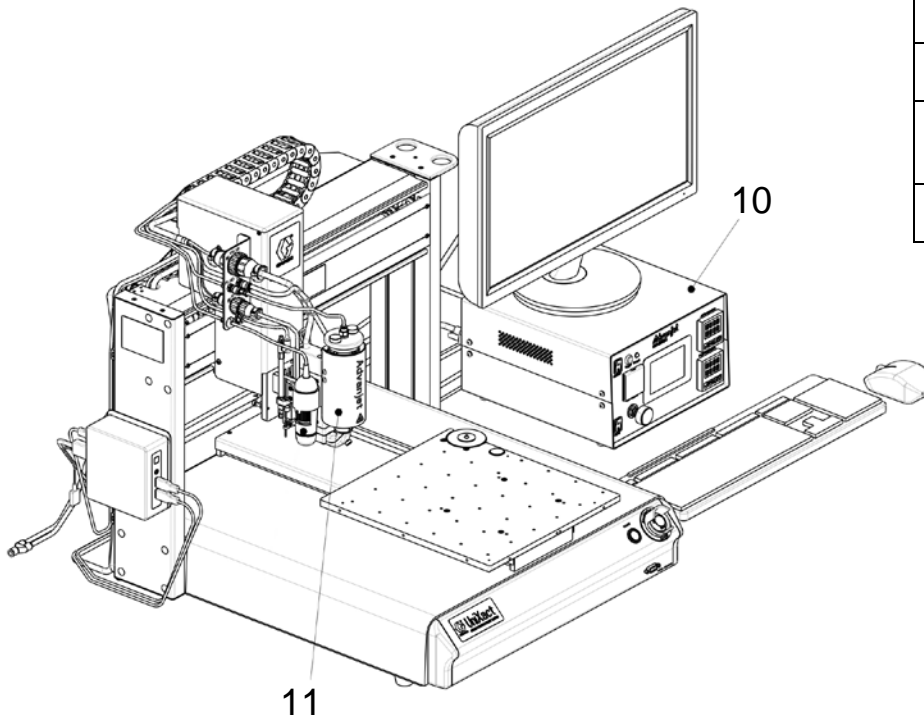

Figure 2: UniXact Automated Jet Dispense System Model 25B353 with Advanjet® HM-2600 Hotmelt Jet

3. Setup and Connections

NOTICE

Do not store or set up the system in an area where it is directly exposed to sunlight. High temperatures can adversely affect the precision of the system, and sunlight can affect the optical home sensor. Do not operate the robot where electrical noise is present.

3.1 Installation Requirements

1. The system should be placed in a location where the front panel controls can be viewed and accessed.
2. Ventilation holes on the components should not be blocked.
3. The equipment is grounded through the power cord. Connect to a properly grounded power source before operating.

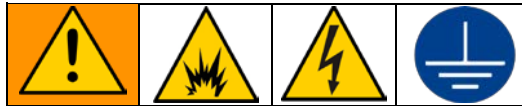

The equipment must be grounded to reduce the risk of static sparking and electric shock. Electric or static sparking can cause fumes to ignite or explode. Improper grounding can cause electric shock. Grounding provides an escape wire for the electric current.

4. The air pressure for the main air supply should be between 70 and 100 psi (0.48 and 0.70 MPa).

NOTICE

It is imperative that the air supplied to the jet is clean, dry, and free from debris and water. A 40 micron filter is highly recommended. If the air is not clean and dry, serious damage can occur to the air solenoid valves.

3.2 Setup Overview

1. Remove shipping brackets
2. Attach the PC
3. Connect the controller and robot
4. Connect the PC
5. Mount the jet
6. Connect the jet
7. Turn on power
8. Test system components (pneumatics, communication, I/O, emergency stop)

3.3 Remove Shipping Brackets

To protect the equipment, the robot is shipped with a locking mechanism for each axis:

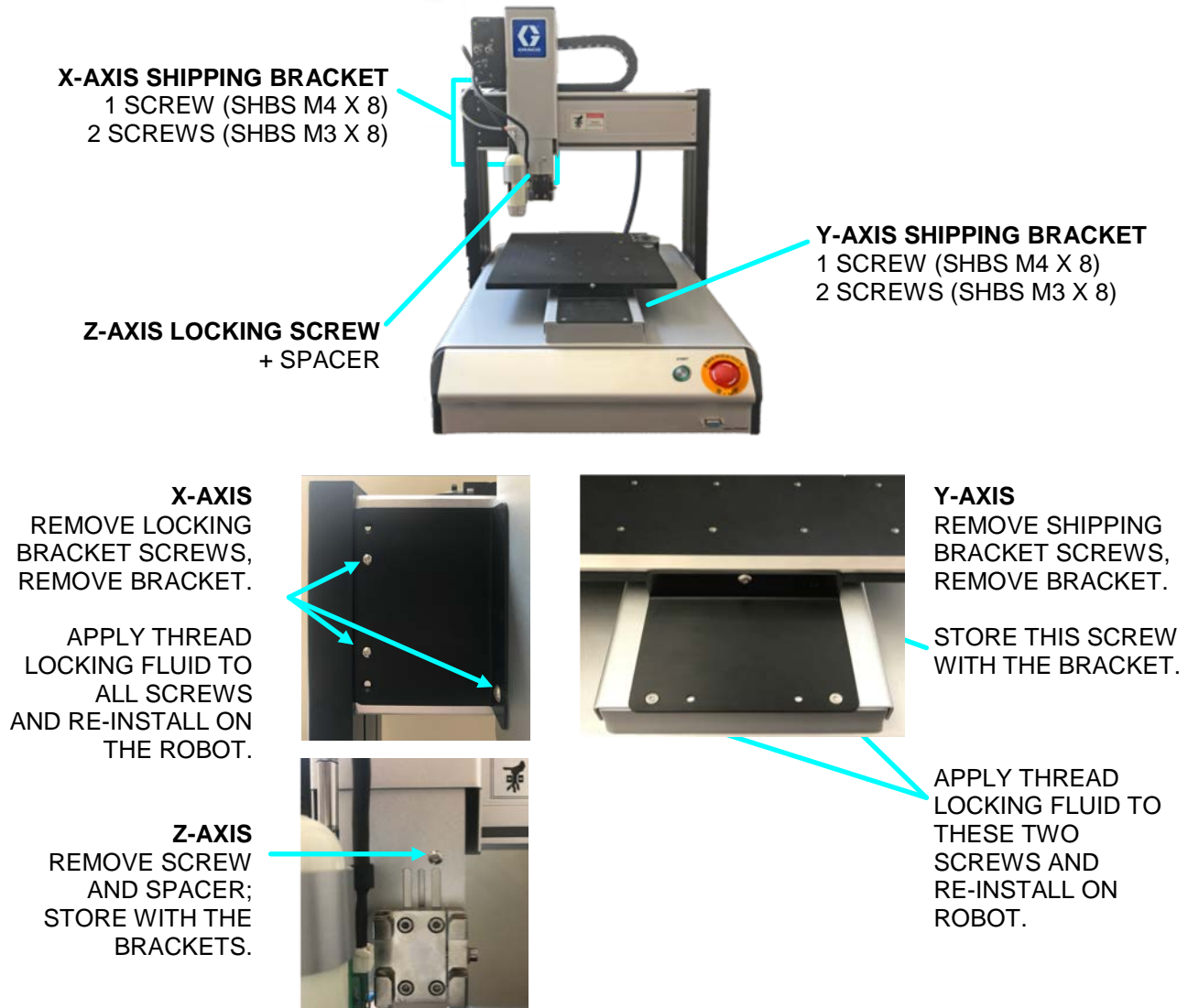

3.4 Attach the PC

The PC mounting bracket is attached to the robot. Insert the PC mounting pins straight into the bracket and push straight down.



Figure 5: PC Mounting Bracket on Robot

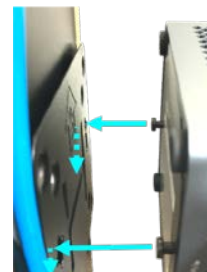

Figure 4: Push Mounting Pins In and Down

3.5 Connect Cables and Air Lines

Note: To assure proper connections, component cables supplied by Advanjet have a distinct connector.

| # | CABLE | TYPE | FROM | To |
|----|----------------|-----------------|--------------------|----------------------------|
| 1 | Jet | CPC 28 | Robot | Controller, JET |
| 2 | Fluid Pressure | Tubing (CLEAR) | Robot | Controller, FLUID PRESSURE |
| 3 | Jet Pressure | Tubing, (BLACK) | Robot | Controller, JET PRESSURE |
| 4 | Air In | Tubing, (BLUE) | Robot | Controller, AIR IN |
| 5 | I/O | DB-26 | Controller, I/O | Robot, I/O PORT |
| 6 | RS-232 | DB9 / USB | Controller, RS-232 | PC (REAR) |
| 7 | RS-232 | DB9 / USB | Robot, RS-232 | PC (REAR) |
| 8 | Main Air | Tubing, (BLUE) | Main air supply | Y fitting |
| 9 | Monitor | HDMI / HD15 | Monitor | PC (REAR) |
| 10 | Camera | USB | Robot | PC (FRONT) |

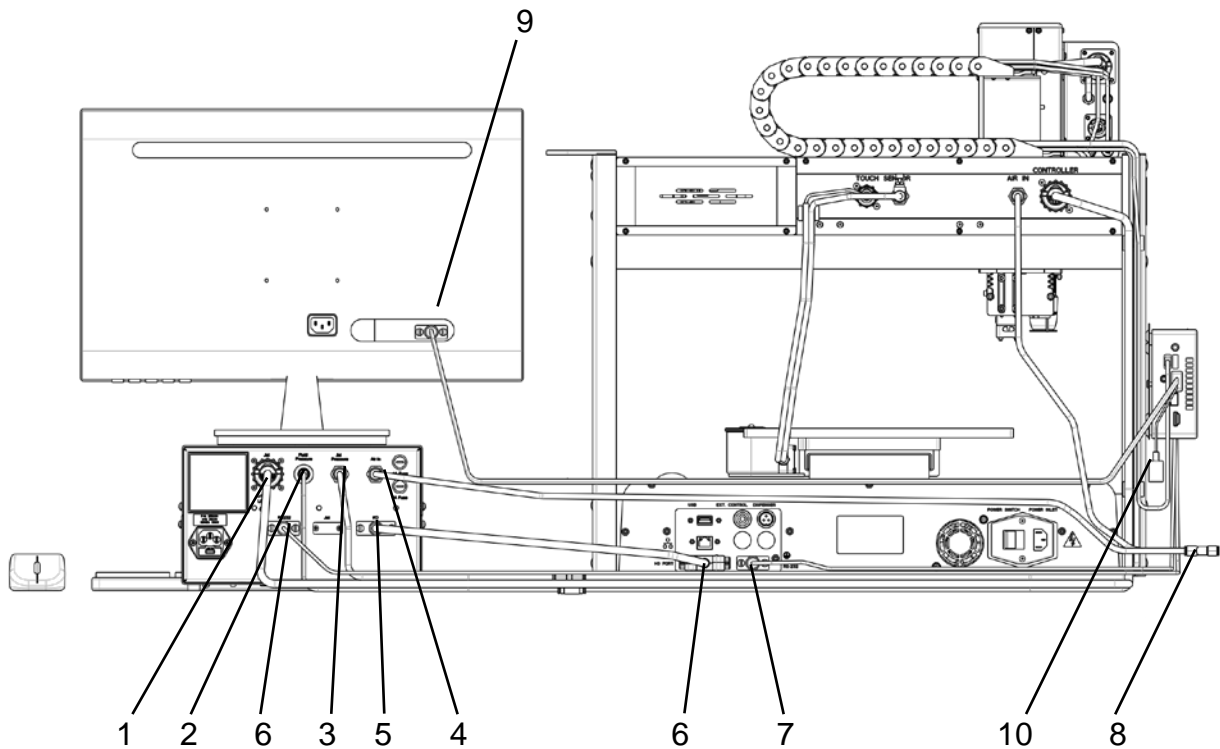

Figure 6: Controller and Robot Cable and Air Line Connections

3.6 Connect PC and Peripherals

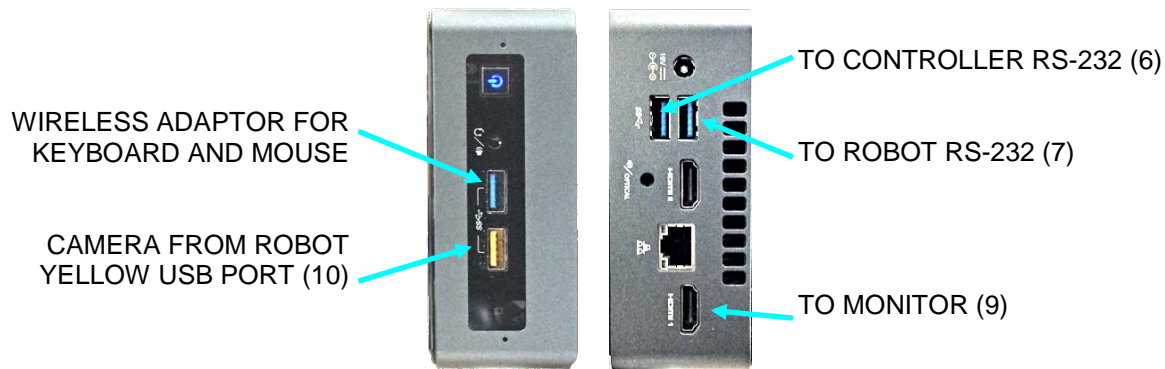

Figure 7: PC Front and Rear Connections

3.7 Mount the Jet

Before attaching the jet, make sure that the controller Power switch and Fluid Air switch are both OFF.

1. Locate the quick-release jet mount. The jet mount is installed at the factory with the bottom of the jet mount sitting flush with the bottom of the Z mounting plate.
2. Determine the correct jet mount position. For proper placement, lines are notched into the Z head at 3 mm intervals, as shown in Figure 8.

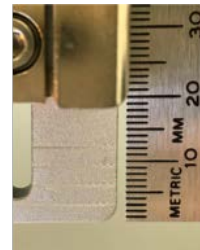

Figure 8: Notched Lines at 3 mm Intervals



Figure 9: Install Jet Mount Flush for Flat Nozzles; Adjust Jet Mount Upward for 3 mm or 6 mm Nozzles

- The flush mount position is for standard flat nozzles. Align the jet mount bottom with the bottom of the Z head, as shown in Figure 9 (left).
 - For 3 mm nozzles, align the jet mount bottom with the first line (3 mm up), as shown in Figure 9 (center).
 - For 6 mm nozzles, align the jet mount bottom with the second line (6 mm up), as shown in Figure 9 (right).
3. Use a 3 mm wrench to tighten the four jet mount screws.
 4. Insert the bottom of the dovetail bracket into the middle slot of the jet mount, as shown in Figure 11. Push down firmly.
 5. Tighten the jet mount screw, as shown in Figure 11.



Figure 11: Slide Jet Into Mount (Flush Position Shown)



Figure 11: Tighten the Mounting Screw

3.8 Connect Jet Cables to Robot Z Head

Note: Connect the cables in the order listed to avoid unintended dispensing (and the resultant mess).



Figure 12:
Jet Connections on the
Robot Z Head

1. Attach the Jet **Valve** Cable. Align the connector and twist the locking ring to tighten.
2. Attach the CLEAR **Fluid** Air Pressure tubing and push it straight into the FLUID connector until it clicks.
3. Attach the BLACK **Jet** Air Pressure tubing and push it straight into the JET connector until it clicks.
4. Attach the Height Sensor (**HTS**) cable. Align the connector and twist the locking ring to tighten.

3.9 Connect Components to Power

There are four power connections for the UniXact Automated Jet Dispense System:

- UniXact Tabletop Robot
- Advanjet HV-2100C or HM-2600C Controller
- Monitor
- PC (via power adapter)

A power cord/adaptor set (P/N 25E557) with connectors for each of the regions listed is provided for the robot, the controller, and the monitor:

- Standard 115 V, 10A cord for USA, Mexico, Canada, Taiwan, and similar
- 250V cord for continental Europe
- Adapter for UK, Australia, and similar

For the PC, a set of regional 320-C5 adapters is provided (P/N 25E758).

The camera is powered through the robot via USB. The keyboard and mouse use batteries.

The controller and robot are grounded through their power cords. Connect the power cords to a properly grounded power source before operating.

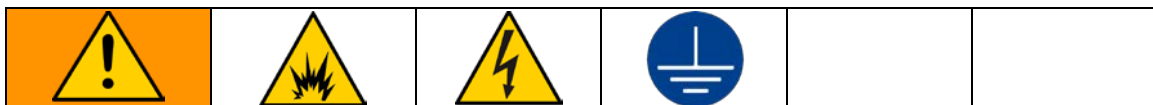

The equipment must be grounded to reduce the risk of static sparking and electric shock. Electric or static sparking can cause fumes to ignite or explode. Improper grounding can cause electric shock. Grounding provides an escape wire for the electric current.

4. Power and Test Components

4.1 Turn On Power to System Components

Note: Turn on power in the order listed.

1. **Advanjet Controller:** Use the main power switch on the controller front panel.
2. **Monitor:** Use the main power button on the front of the monitor.
3. **Keyboard and Mouse** are battery powered and have individual power switches. Wireless communication is enabled when PC is powered on.
4. **Robot:** Use the Main power switch on the robot rear panel.

Note: After turning on the Robot power, wait for the beep before booting the PC and running the Dispense Pro Software. This can take up to 40 seconds.

5. **PC:** Use the power button on the PC front

4.2 Test Pneumatic Connections

1. Use the Jet Pressure Regulator to set Jet Pressure to 40 psi (0.28 MPa).



2. Press the **Trigger** button and listen for the air bursts when the valve closes and opens.

4. Turn the **Fluid Air** switch ON. Listen for air flowing from the fluid receiver head.



3. Tap **Fluid Pressure** on the Controller touch screen. When the field shows a red border, tap **Keypad** and set Fluid Pressure to 20 psi (0.14 MPa).

4.3 Test Communication and I/O Connections

1. Double click on the DispensePro icon to start the program.



2. A screen prompt asks for permission to move the X-Y table.

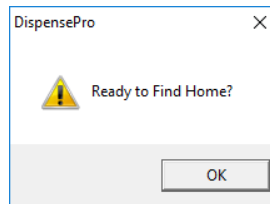

The X-Y table will not move until permission is granted. Click **OK**.

The robot moves to the X-Y-Z home position at the left rear corner of the table.

3. In the navigation window of the DispensePro home screen, click on a point in the work surface area to move the robot. The robot should move to that location.

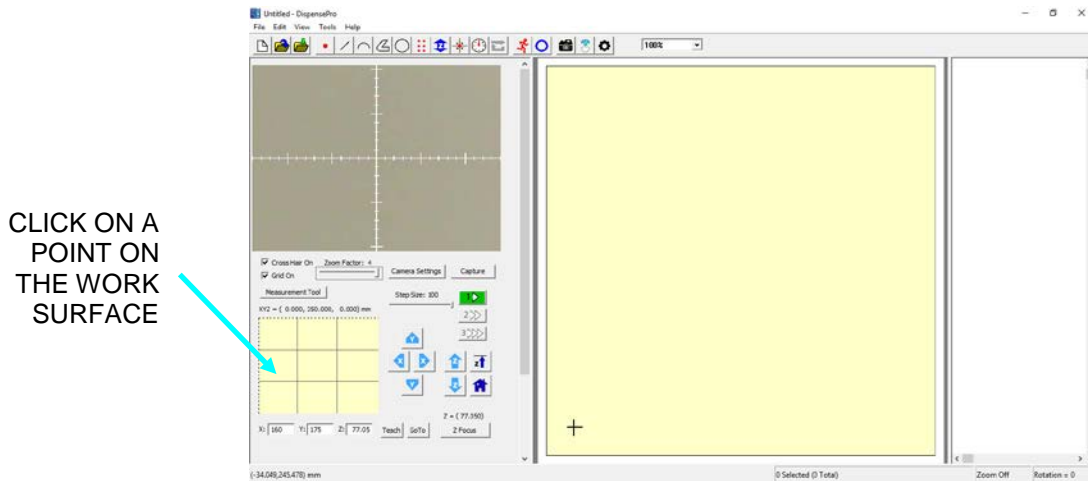

4. Install the diaphragm and nozzle plate on the jet before proceeding with system calibration and programming. See the HV-2100 Jet manual (3A6244) or HM-2600 Hotmelt Jet manual (3A6226) and the DispensePro Software manual (3A5914).

4.4 Test Emergency Stop

Should it become necessary to immediately halt dispensing, the Emergency Stop button on the front of the Robot will cut power to the X, Y, and Z motors, halt air pressure, and turn off the heaters.



Figure 13: Emergency Stop Button on Robot Front

To test the Emergency Stop:

1. Press the **Emergency Stop** button. Power to the X, Y, and Z motors on the robot is removed and the robot will start to beep.
2. Verify that the power is removed by gently moving the X, Y, and Z axes by hand. There will be some resistance to motion, but each axis should move freely.
 - X-Axis: Move the Z-head left and right
 - Y-Axis: Move the work surface table back and forward.
 - Z-Axis: Move jet mount up and down
3. Press the red **Trigger** button on the Controller. There should be no air sound from the Jet.
4. Check the PV on the heater controller. Jet temperature should be falling.
5. Verify the software is showing the message below:

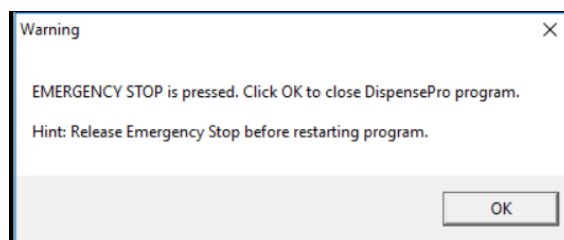



To recover from an Emergency Stop:

1. Turn the Emergency Stop button clockwise.
2. Follow the procedure for turning on the power in Section 4.1.

4.5 Turn Off Power to System Components

Note: Turn off power in the order listed.

1. Close all programs and exit DispensePro.
2. **PC:** Click the Windows Start icon , then click the power button  and select **Shut Down**.
3. **Monitor:** Use the main power button on the front of the monitor.
4. **Robot:** Use the Main power switch on the robot rear panel.
5. **Advanjet Controller:** Use the main power switch on the controller front panel.

Graco Standard Warranty

Graco warrants all equipment referenced in this document which is manufactured by Graco and bearing its name to be free from defects in material and workmanship on the date of sale to the original purchaser for use. With the exception of any special, extended, or limited warranty published by Graco, Graco will, for a period of twelve months from the date of sale, repair or replace any part of the equipment determined by Graco to be defective. This warranty applies only when the equipment is installed, operated and maintained in accordance with Graco's written recommendations.

This warranty does not cover, and Graco shall not be liable for general wear and tear, or any malfunction, damage or wear caused by faulty installation, misapplication, abrasion, corrosion, inadequate or improper maintenance, negligence, accident, tampering, or substitution of non-Graco component parts. Nor shall Graco be liable for malfunction, damage or wear caused by the incompatibility of Graco equipment with structures, accessories, equipment or materials not supplied by Graco, or the improper design, manufacture, installation, operation or maintenance of structures, accessories, equipment or materials not supplied by Graco.

This warranty is conditioned upon the prepaid return of the equipment claimed to be defective to an authorized Graco distributor for verification of the claimed defect. If the claimed defect is verified, Graco will repair or replace free of charge any defective parts. The equipment will be returned to the original purchaser transportation prepaid. If inspection of the equipment does not disclose any defect in material or workmanship, repairs will be made at a reasonable charge, which charges may include the costs of parts, labor, and transportation.

THIS WARRANTY IS EXCLUSIVE, AND IS IN LIEU OF ANY OTHER WARRANTIES, EXPRESS OR IMPLIED, INCLUDING BUT NOT LIMITED TO WARRANTY OF MERCHANTABILITY OR WARRANTY OF FITNESS FOR A PARTICULAR PURPOSE.

Graco's sole obligation and buyer's sole remedy for any breach of warranty shall be as set forth above. The buyer agrees that no other remedy (including, but not limited to, incidental or consequential damages for lost profits, lost sales, injury to person or property, or any other incidental or consequential loss) shall be available. Any action for breach of warranty must be brought within two (2) years of the date of sale.

GRACO MAKES NO WARRANTY, AND DISCLAIMS ALL IMPLIED WARRANTIES OF MERCHANTABILITY AND FITNESS FOR A PARTICULAR PURPOSE, IN CONNECTION WITH ACCESSORIES, EQUIPMENT, MATERIALS OR COMPONENTS SOLD BUT NOT MANUFACTURED BY GRACO. These items sold, but not manufactured by Graco (such as electric motors, switches, hose, etc.), are subject to the warranty, if any, of their manufacturer. Graco will provide purchaser with reasonable assistance in making any claim for breach of these warranties.

In no event will Graco be liable for indirect, incidental, special or consequential damages resulting from Graco supplying equipment hereunder, or the furnishing, performance, or use of any products or other goods sold hereto, whether due to a breach of contract, breach of warranty, the negligence of Graco, or otherwise.

FOR GRACO CANADA CUSTOMERS

The Parties acknowledge that they have required that the present document, as well as all documents, notices and legal proceedings entered into, given or instituted pursuant hereto or relating directly or indirectly hereto, be drawn up in English. Les parties reconnaissent avoir convenu que la rédaction du présente document sera en Anglais, ainsi que tous documents, avis et procédures judiciaires exécutés, donnés ou intentés, à la suite de ou en rapport, directement ou indirectement, avec les procédures concernées.

Graco Information

For the latest information about Advanjet products, visit www.advanjet.com.

For patent information, see www.graco.com/patents.

For customer service and technical assistance, e-mail info@advanjet.com

TO PLACE AN ORDER, contact orders@advanjet.com

If calling from the US: 800-333-4877

If calling from outside the US: +1-760-294-3392

All written and visual data contained in this document reflects the latest product information available at the time of publication.

Graco reserves the right to make changes at any time without notice.

Original instructions. This manual contains English. MM 3A5913

Graco Headquarters: Minneapolis

International Offices: Belgium, China, Japan, Korea

GRACO INC. AND SUBSIDIARIES • P.O. BOX 1441 • MINNEAPOLIS MN 55440-1441 • USA

Copyright 2019, Graco Inc. All Graco manufacturing locations are registered to ISO 9001.

www.graco.com

Revision B, September 2019