

Harrier+[®] Chemical Injection Controller

3A4130L
EN

For controlling and monitoring an automated chemical injection system. Approved for use in Class I, Div 2, Groups A, B, C, D, T4.

See page 3 for approvals and model information.



Important Safety Instructions

Read all warnings and instructions in this manual.
Save these instructions.

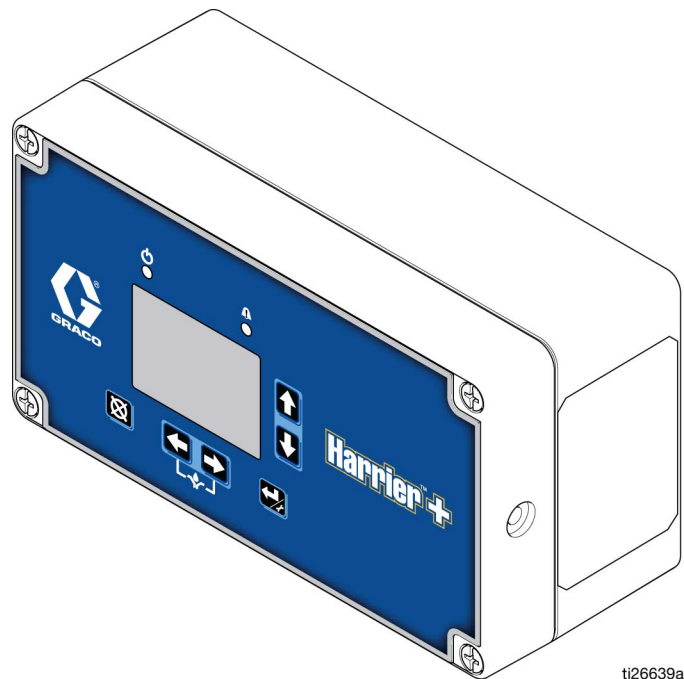

Table of Contents

| | | | |
|-------------------------------------------------|-----------|--------------------------------------------------|-----------|
| Approvals | 3 | Troubleshooting | 72 |
| Related Manuals | 3 | Cellular Connection Status Codes | 74 |
| Models | 3 | Program Settings | 75 |
| Warnings | 4 | Dimensions and Mounting Hole Layout | 77 |
| Component Identification | 6 | Kits and Accessories | 77 |
| Keypad, Display, and Icons | 6 | Appendix A: Modbus Interface | 78 |
| Installation | 9 | PC Interface | 78 |
| Installation of the Injection Controller | 9 | PLC Interface | 78 |
| Grounding | 9 | Variable Maps | 79 |
| Antenna Connection | 9 | Technical Data | 93 |
| Typical 12 or 24 VDC Installation and Wiring .. | 10 | California Proposition 65 | 93 |
| Typical 120 VAC Installation and Wiring | 14 | Graco Standard Warranty | 94 |
| Typical 240 VAC Installation and Wiring | 18 | | |
| Wiring Diagrams | 22 | | |
| Theory of Operation | 30 | | |
| Flow Control Summary | 30 | | |
| Cycle Control Summary | 30 | | |
| Time Control Summary | 30 | | |
| Pump Calibration | 30 | | |
| Controller Setup | 31 | | |
| Configuration Screen | 31 | | |
| Pump Setup Screen (Flow Mode) | 31 | | |
| Pump Setup Screen (Time Mode) | 36 | | |
| Pump Setup Screen (Cycle Mode) | 37 | | |
| Alarms Setup Screen | 38 | | |
| PIN Code Setup Screen | 43 | | |
| PIN Code Entry Screen | 44 | | |
| Network Setup Screen | 44 | | |
| Advanced Setup Screen | 46 | | |
| Fluid Pressure Setup Screen | 51 | | |
| Tank Level Setup Screen | 51 | | |
| Run Screens | 52 | | |
| Screen Identification | 52 | | |
| Alarms and Signal Events | 53 | | |
| Harrier+ Web Portal | 55 | | |
| Create a New Account | 56 | | |
| Log In to the Web Portal | 58 | | |
| Pumps List Screen | 60 | | |
| Pumps Detail Screen (Pump Connected) | 61 | | |
| Pumps Detail Screen (Pump Disconnected) ... | 65 | | |
| Groups List Screen | 66 | | |
| Groups Detail Screen | 67 | | |
| Invitation to Join a Group | 69 | | |
| Settings Screen | 70 | | |
| Help Screen | 71 | | |

Approvals



Related Manuals







| Manual No. | Description |
|------------|---------------------------------------------|
| 3A3100 | Wolverine Premium Chemical Injection System |
| 334513 | Wolverine Chemical Injection Pump |
| 3A5375 | Tank Level Monitoring Kit |
| 3A3210 | Firmware Update Manual |
| 3A3944 | Pressure Sensor Kit |

Models

| Part No. | Description |
|----------|---------------------------------------------------------------------------|
| B32627 | Harrier+ Controller, DC Power, Cellular - USA only (GSM - AT&T) |
| B32628 | Harrier+ Controller, AC Power, Cellular - USA only (GSM - AT&T) |
| B32629 | Harrier+ Controller, DC Power, Cellular - Global (limited use in USA) |
| B32630 | Harrier+ Controller, AC Power, Cellular - Global (limited use in USA) |
| B32631 | Harrier+ Controller, DC Power, SCADA via MODBUS |
| B32632 | Harrier+ Controller, AC Power, SCADA via MODBUS |
| B32833 | Harrier+ MPI Controller, DC Power, Cellular - USA only (GSM - AT&T) |
| B32834 | Harrier+ MPI Controller, AC Power, Cellular - USA only (GSM - AT&T) |
| B32835 | Harrier+ MPI Controller, DC Power, Cellular - Global (limited use in USA) |
| B32836 | Harrier+ MPI Controller, AC Power, Cellular - Global (limited use in USA) |
| B32837 | Harrier+ MPI Controller, DC Power, SCADA via MODBUS |
| B32838 | Harrier+ MPI Controller, AC Power, SCADA via MODBUS |

Warnings

The following warnings are for the setup, use, grounding, maintenance, and repair of this equipment. The exclamation point symbol alerts you to a general warning and the hazard symbols refer to Procedure-specific risks. When these symbols appear in the body of this manual or on warning labels, refer back to these Warnings. Product-specific hazard symbols and warnings not covered in this section may appear throughout the body of this manual where applicable.

|  WARNING | |
|----------------------------------------------------------------------------------------------------------------------------------------------------------------------------|--------------------------------------------------------------------------------------------------------------------------------------------------------------------------------------------------------------------------------------------------------------------------------------------------------------------------------------------------------------------------------------------------------------------------------------------------------------------------------------------------------------------------------------------------------------------------------------------------------------------------------------------------------------------------------------------------------------------------------------------------------------------------------------------------------------------------------------------------------------------------------------------------------------------|
|   | <p>FIRE AND EXPLOSION HAZARD</p> <p>When flammable fluids are present in the work area be aware that flammable fumes can ignite or explode. To help prevent fire and explosion:</p> <ul style="list-style-type: none"> • Use equipment only in well ventilated area. • Eliminate all ignition sources, such as cigarettes and portable electric lamps. • Ground all equipment in the work area. • Keep work area free of debris, including rags and spilled or open containers of solvent. • Do not plug or unplug power cords or turn lights on or off when flammable fumes are present. • Use only grounded hoses. • Stop operation immediately if static sparking occurs or you feel a shock. Do not use equipment until you identify and correct the problem. • Keep a working fire extinguisher in the work area. |
|  | <p>FIRE AND EXPLOSION HAZARD</p> <p>Static charge may build up on plastic parts during cleaning and could discharge and ignite flammable vapors. To help prevent fire and explosion:</p> <ul style="list-style-type: none"> • Clean plastic parts only in well ventilated area. • Do not clean with a dry cloth. |
|   | <p>ELECTRIC SHOCK HAZARD</p> <p>This equipment must be grounded. Improper grounding, setup, or usage of the system can cause electric shock.</p> <ul style="list-style-type: none"> • Turn off and disconnect power at main switch before disconnecting any cables and before servicing or installing equipment. • Connect only to grounded power source. • All electrical wiring must be done by a qualified electrician and comply with all local codes and regulations. |

 **WARNING****EQUIPMENT MISUSE HAZARD**

Misuse can cause death or serious injury.

- Do not operate the unit when fatigued or under the influence of drugs or alcohol.
- Do not exceed the maximum working pressure or temperature rating of the lowest rated system component. See **Technical Data** in all equipment manuals.
- Use fluids and solvents that are compatible with equipment wetted parts. See **Technical Data** in all equipment manuals. Read fluid and solvent manufacturer's warnings. For complete information about your material, request Safety Data Sheet (SDS) from distributor or retailer.
- Turn off all equipment and follow the **Pressure Relief Procedure** when equipment is not in use.
- Check equipment regularly. Repair or replace worn or damaged parts immediately with genuine manufacturer's replacement parts only.
- Do not alter or modify equipment. Alterations or modifications may void agency approvals and create safety hazards.
- Make sure all equipment is rated and approved for the environment in which you are using it.
- Use equipment only for its intended purpose. Call your distributor for information.
- Route hoses and cables away from traffic areas, sharp edges, moving parts, and hot surfaces.
- Keep children and animals away from work area.
- Comply with all applicable safety regulations.

Component Identification

Keypad, Display, and Icons

NOTICE

To prevent damage to soft key buttons, do not press the buttons with sharp objects such as pens, plastic cards, or fingernails.

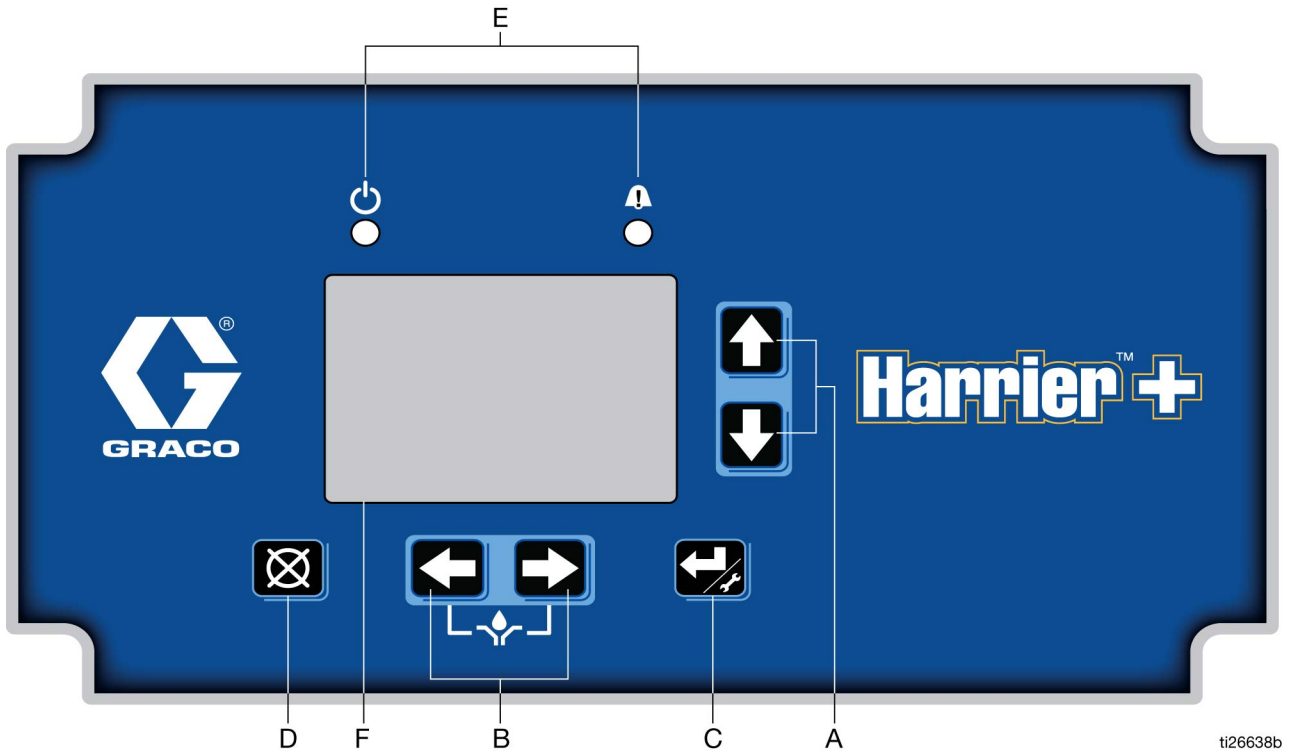

ti26638b

FIG. 1: Harrier+ Keypad and Display

Run Mode Functions

Direction Arrows

- A Up and Down Arrow Keys:
- Navigate screen menus.
 - Increase or decrease values in numeric fields.
- B Left and Right Arrow Keys:
- Navigate screen menus.
 - Press both keys simultaneously to manually start a pump cycle or prime the pump.
 - Moves one digit to the left or right to edit numeric fields.

Keypad Icons

NOTE: Keypad icons are described on page 7.

- C Enter Key: Press and hold for 3 seconds to access the Configuration screen (see FIG. 19, page 31). Also is used to save changes to setup fields (see **Setup Screens**, starting on page 31).
- D Reset Key: Resets unit to the pump run screen. Also is used to reset an alarm condition.
- E Function LED: See page 7 for a description of these icons.
- F Display

Icons

The following icons are used throughout this instruction manual and on the Controller's Run and Setup Screens. Refer to this table if you are unsure of an icon's meaning.



Power On indicator. When power is supplied to the controller, Green LED illuminates under Function Icon located above the display screen.



Pump On indicator. Displayed on right side of Pump Run screen during the Pump On cycle.



Pump Off indicator. Displayed on right side of Run screen during the Pump Off cycle.



Setup Mode active. Displayed on the upper right corner of the Configuration screen.



Time Mode active. Displayed on top right side of screen when the Time Run screen is displayed.



Cycle count Mode active. Displayed on top right side of the display screen when the Cycle Run screen is displayed.



Alarm active. Red LED illuminates under the Function LED located above the display screen when an alarm event occurs.



Flow Mode active. Displayed on the top right side of the display screen when the Flow Run screen is displayed.



Signal Strength. Displayed on the Network screen when Cell is selected and cell signal detected.



DC Voltage. Displayed next to the battery voltage on the left side of Run screen. (Applies to DC models only.)



Pressure. Displayed next to the pressure reading on the left side of Run screen.



Tank Level. Displayed next to the tank level reading on the left side of Run screen.



Temperature. Displayed next to the temperature reading on the left side of the Run screen. The temperature is measured by the temperature probe.

Installation

Installation of the Injection Controller



AUTOMATIC SYSTEM ACTIVATION HAZARD

Unexpected activation of the system could result in serious injury, including skin injection and amputation.

This device has an automatic timer that activates the chemical injection system when power is connected or when exiting the programming function. The device can also be activated remotely from internet portals. Before you install or remove the controller from the system, disconnect and isolate all power supplies, and relieve all pressure.

1. Select a flat surface to install the Injection Controller. Refer to **Dimensions and Mounting Hole Layout** on page 77.

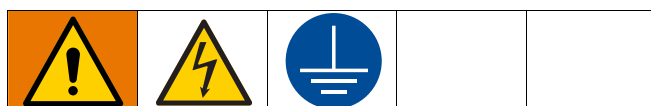

All electrical wiring must be done by a qualified electrician and comply with all local codes and regulations.

Opening the controller to remove the screws that attach the mounting plate to the controller may expose the assembler to live voltage. Do not remove the mounting plate.

2. Align the mounting surface with predrilled holes on mounting plate. Use mounting studs (provided) with two 1/4-20 nuts (not provided).

NOTICE

Use only designated mounting plates and holes in controller enclosure. Do not drill additional mounting holes, or short wires together, as it can cause circuit board damage.

Grounding



The equipment must be grounded to reduce the risk of static sparking and electric shock. Electric or static sparking can cause fumes to ignite or explode. Improper grounding can cause electric shock. Grounding provides an escape wire for the electric current.

Controller:

DC models - ground the controller by attaching the mounting bracket to a grounded surface.

AC models - ground the controller by attaching the ground wire from the harness to a true earth ground.

Antenna Connection



Removing or replacing the antenna while the circuit is live may spark ignitable fumes in the area. To reduce the risk of ignition, do not remove or replace the antenna while the circuit is live unless the area is free of ignitable fumes.

Typical 12 or 24 VDC Installation and Wiring

FIG. 2 is an example of 12 or 24 VDC installation. Your installation may differ from what is shown here. The Harrier+ controller (G), with wiring, is supplied by Graco. All other components are supplied by the customer. Contact your Graco distributor for assistance in planning a system to suit your needs.

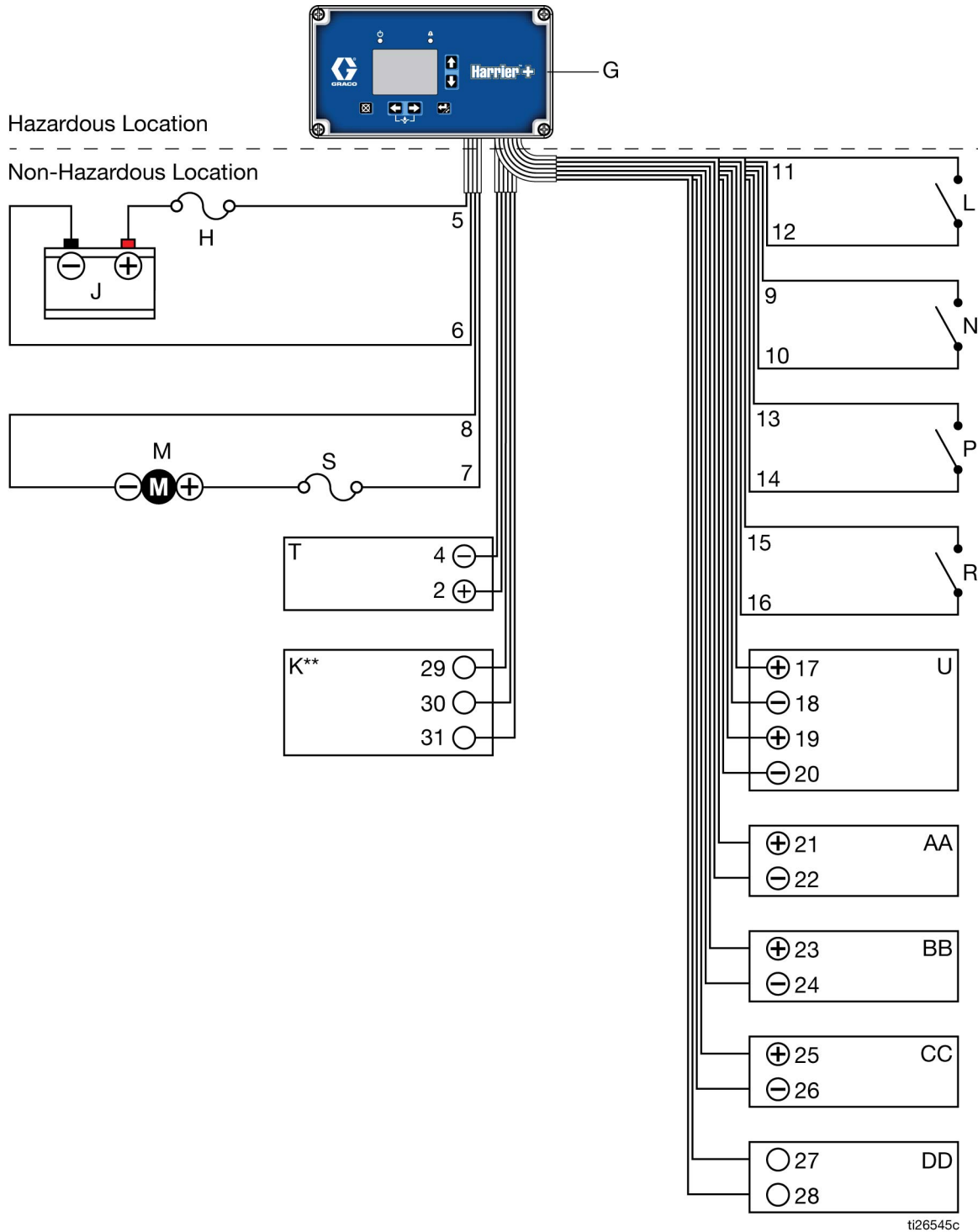

FIG. 2: Typical 12 or 24 VDC Installation

Key:

| | |
|-----------|---------------------------------------------------------|
| G | Controller |
| H | In-line Fuse* (battery) - UL 248 approved, 30A max (DC) |
| J | Battery (12 or 24 VDC) |
| K | RS232 SCADA Interface** (optional, SCADA models only) |
| L | Auxiliary Switch (optional) |
| M | Pump Motor |
| N | Cycle Counter for System Control |
| P | Alarm Input #1 (optional) |
| R | Alarm Input #2 (optional) |
| S | In-line Fuse* (pump) - UL 248 approved, 30A max*** (DC) |
| T | Battery Monitor (optional) |
| U | Pressure Transducer (optional) |
| AA | Tank Level Monitor (optional) |
| BB | Analog In (optional) |
| CC | Analog Out (optional) |
| DD | Temperature Probe (optional) |

* *UL 248 approved fuses are to be provided by the user.*

** *RS232 communication is available on SCADA models. Gateway adapters to the controller's RS232 interface must be provided by user to support other protocols.*

*** *Sized according to motor nameplate amperage.*

12 or 24 VDC Wiring Diagram

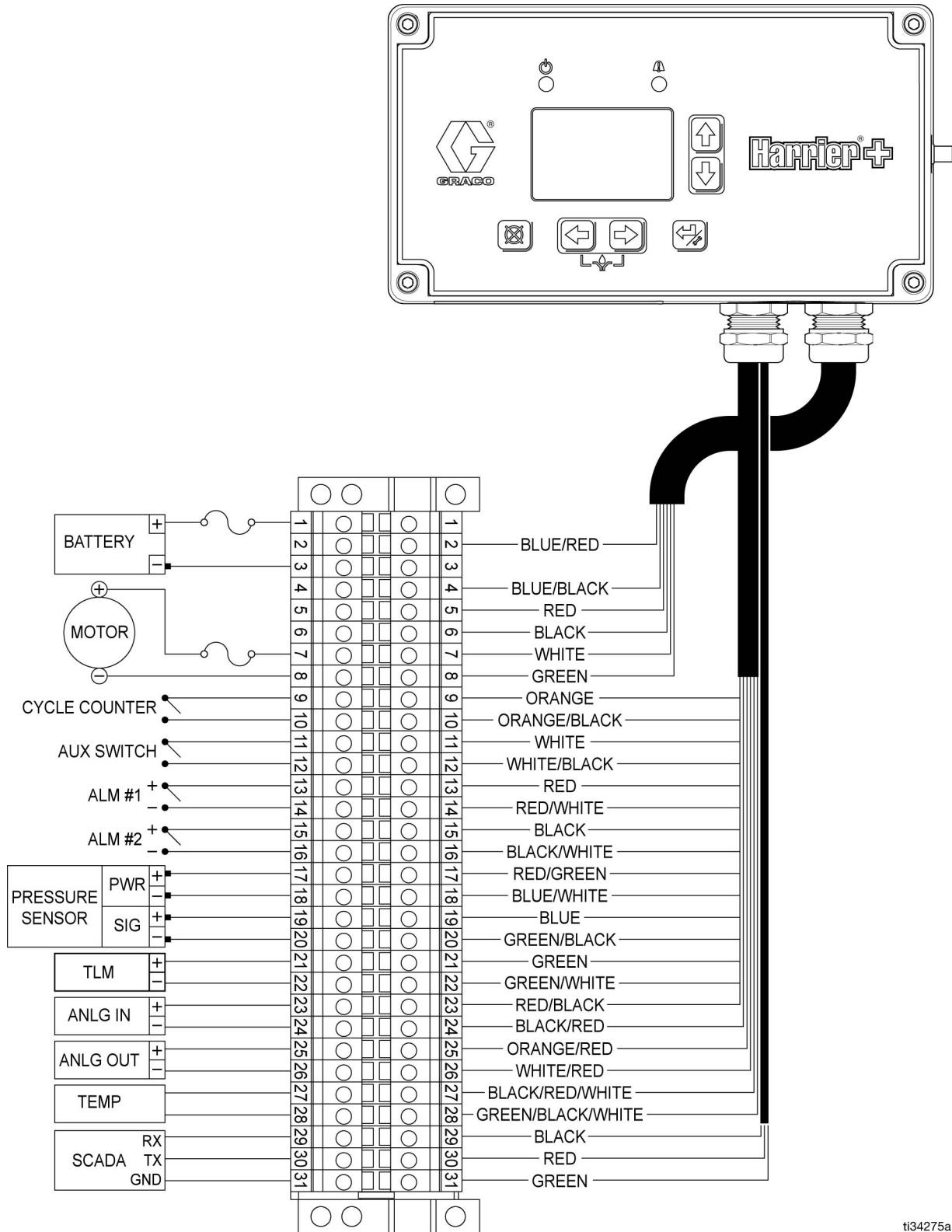

ti34275a

FIG. 3: 12 or 24 VDC Wiring

Wiring Key:

| | | |
|----|--------------------------------|-----------------------------------------|
| 1 | Battery (+) | Jumper (not shown) Harrier+ no connect. |
| 2 | Battery Monitor (+) | blue/red |
| 3 | Battery (-) | Jumper (not shown) Harrier+ no connect. |
| 4 | Battery Monitor (-) | blue/black |
| 5 | Controller (+) | red |
| 6 | Controller (-) | black |
| 7 | Pump Motor (+) | white |
| 8 | Pump Motor (-) | green |
| 9 | Cycle Counter (+) | orange |
| 10 | Cycle Counter (-) | orange/black |
| 11 | Auxiliary Switch (+) | white |
| 12 | Auxiliary Switch (-) | white/black |
| 13 | Alarm #1 (+) | red |
| 14 | Alarm #1 (-) | red/white |
| 15 | Alarm #2 (+) | black |
| 16 | Alarm #2 (-) | black/white |
| 17 | Pressure Transducer Power (+) | red/green |
| 18 | Pressure Transducer Power (-) | blue/white |
| 19 | Pressure Transducer Signal (+) | blue |
| 20 | Pressure Transducer Signal (-) | green/black |
| 21 | Tank Level Monitor (+) | green |
| 22 | Tank Level Monitor (-) | green/white |
| 23 | Analog In (+) | red/black |
| 24 | Analog In (-) | black/red |
| 25 | Analog Out (+) | orange/red |
| 26 | Analog Out (-) | white/red |
| 27 | Temperature Probe | black/red/white |
| 28 | Temperature Probe | green/black/white |
| 29 | SCADA (RX) | black |
| 30 | SCADA (TX) | red |
| 31 | SCADA (GND) | green |

Typical 120 VAC Installation and Wiring

FIG. 4 is an example of 120 VAC installation. Your installation may differ from what is shown here. The Harrier+ controller (G), with wiring, is supplied by Graco. All other components are supplied by the customer. Contact your Graco distributor for assistance in planning a system to suit your needs.

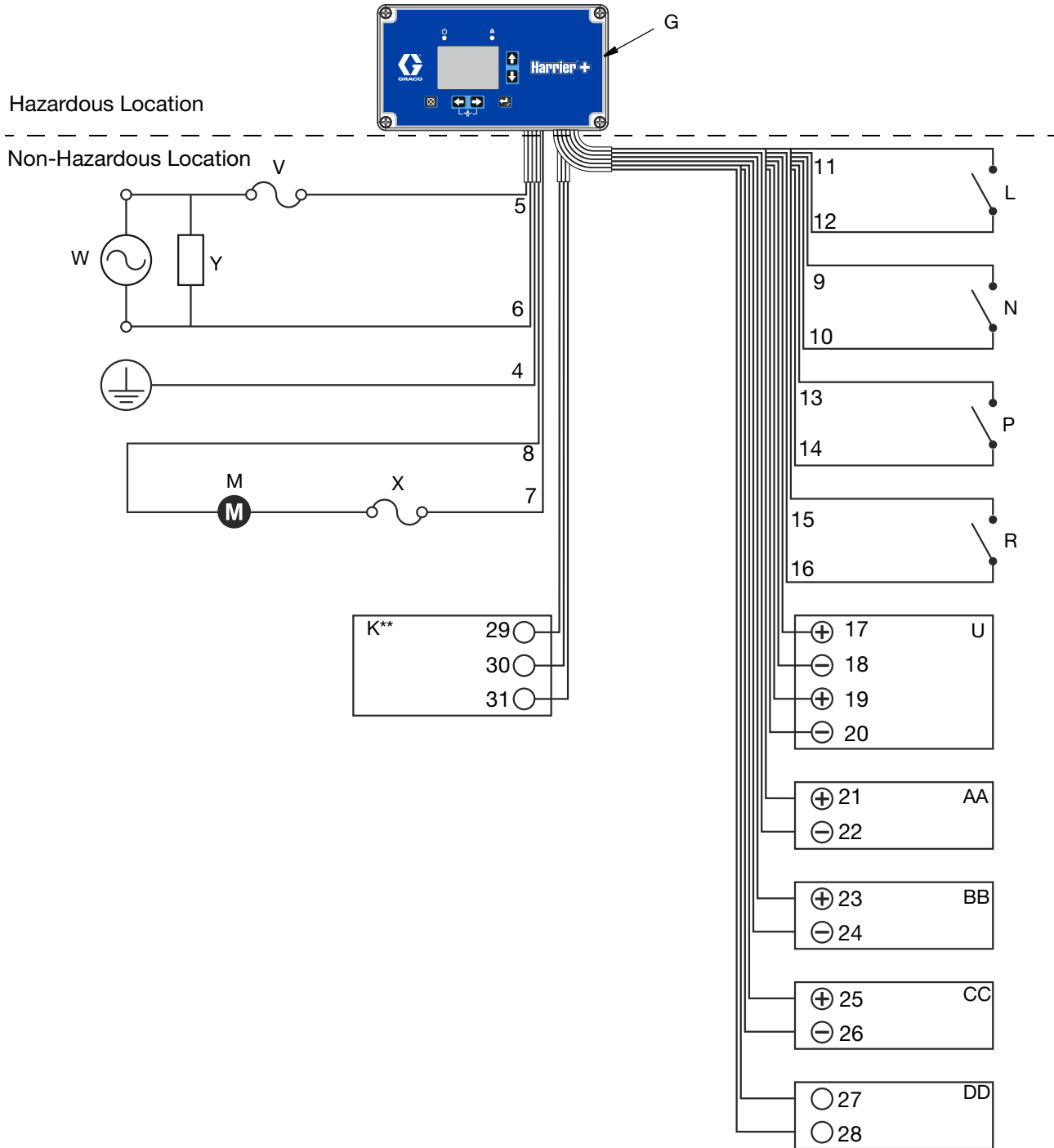

FIG. 4: Typical 120 VAC Installation

Key:

| | |
|-----------|---------------------------------------------------------------|
| G | Controller |
| K | RS232 SCADA Interface** (optional, SCADA models only) |
| L | Auxiliary Switch (optional) |
| M | Pump Motor |
| N | Cycle Counter for System Control |
| P | Alarm Input #1 (optional) |
| R | Alarm Input #2 (optional) |
| U | Pressure Transducer (optional) |
| V | In-line Fuse* (line) - UL 489, Class CC approved, 5A max (AC) |
| W | Line Power (120 VAC) |
| X | In-line Fuse* (line) - UL 489, Class CC approved, 5A max (AC) |
| Y | Surge Protection Device*** |
| AA | Tank Level Monitor (optional) |
| BB | Analog In (optional) |
| CC | Analog Out (optional) |
| DD | Temperature Probe (optional) |

* *UL 489 approved fuses are to be provided by the user.*

** *RS232 communication is available on SCADA models. Gateway adapters to the controller's RS232 interface must be provided by user to support other protocols.*

*** *Type 1, Maximum recommended clamping voltage:*

Line-Line: 1500V

Line-Neutral: 1000V

Max surge current \geq 25kA

(Required for CE)

120 VAC Wiring Diagram

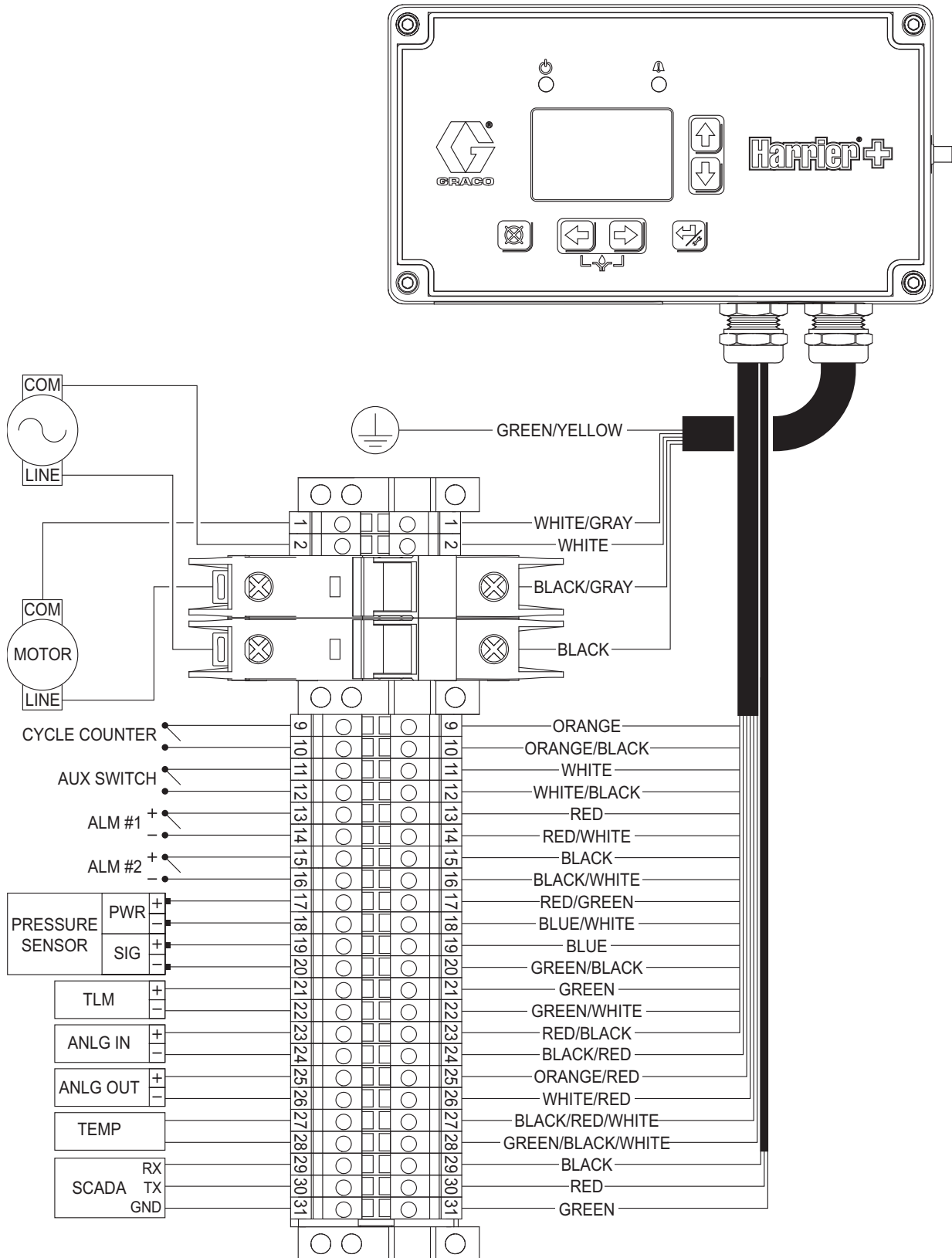

Fig. 5: 120 VAC Wiring Diagram

Wiring Key:

| | | |
|-----------|--------------------------------|-------------------|
| 1 | Motor COM | white/gray |
| 2 | AC COM | white |
| B1 | Motor LINE Breaker | black/gray |
| B2 | AC LINE Breaker | black |
| 9 | Cycle Counter (+) | orange |
| 10 | Cycle Counter (-) | orange/black |
| 11 | Auxiliary Switch (+) | white |
| 12 | Auxiliary Switch (-) | white/black |
| 13 | Alarm #1 (+) | red |
| 14 | Alarm #1 (-) | red/white |
| 15 | Alarm #2 (+) | black |
| 16 | Alarm #2 (-) | black/white |
| 17 | Pressure Transducer Power (+) | red/green |
| 18 | Pressure Transducer Power (-) | blue/white |
| 19 | Pressure Transducer Signal (+) | blue |
| 20 | Pressure Transducer Signal (-) | green/black |
| 21 | Tank Level Monitor (+) | green |
| 22 | Tank Level Monitor (-) | green/white |
| 23 | Analog In (+) | red/black |
| 24 | Analog In (-) | black/red |
| 25 | Analog Out (+) | orange/red |
| 26 | Analog Out (-) | white/red |
| 27 | Temperature Probe | black/red/white |
| 28 | Temperature Probe | green/black/white |
| 29 | SCADA (RX) | black |
| 30 | SCADA (TX) | red |
| 31 | SCADA (GND) | green |

Typical 240 VAC Installation and Wiring

FIG. 6 is an example of 240 VAC installation. Your installation may differ from what is shown here. The Harrier+ controller (G), with wiring, is supplied by Graco. All other components are supplied by the customer. Contact your Graco distributor for assistance in planning a system to suit your needs.

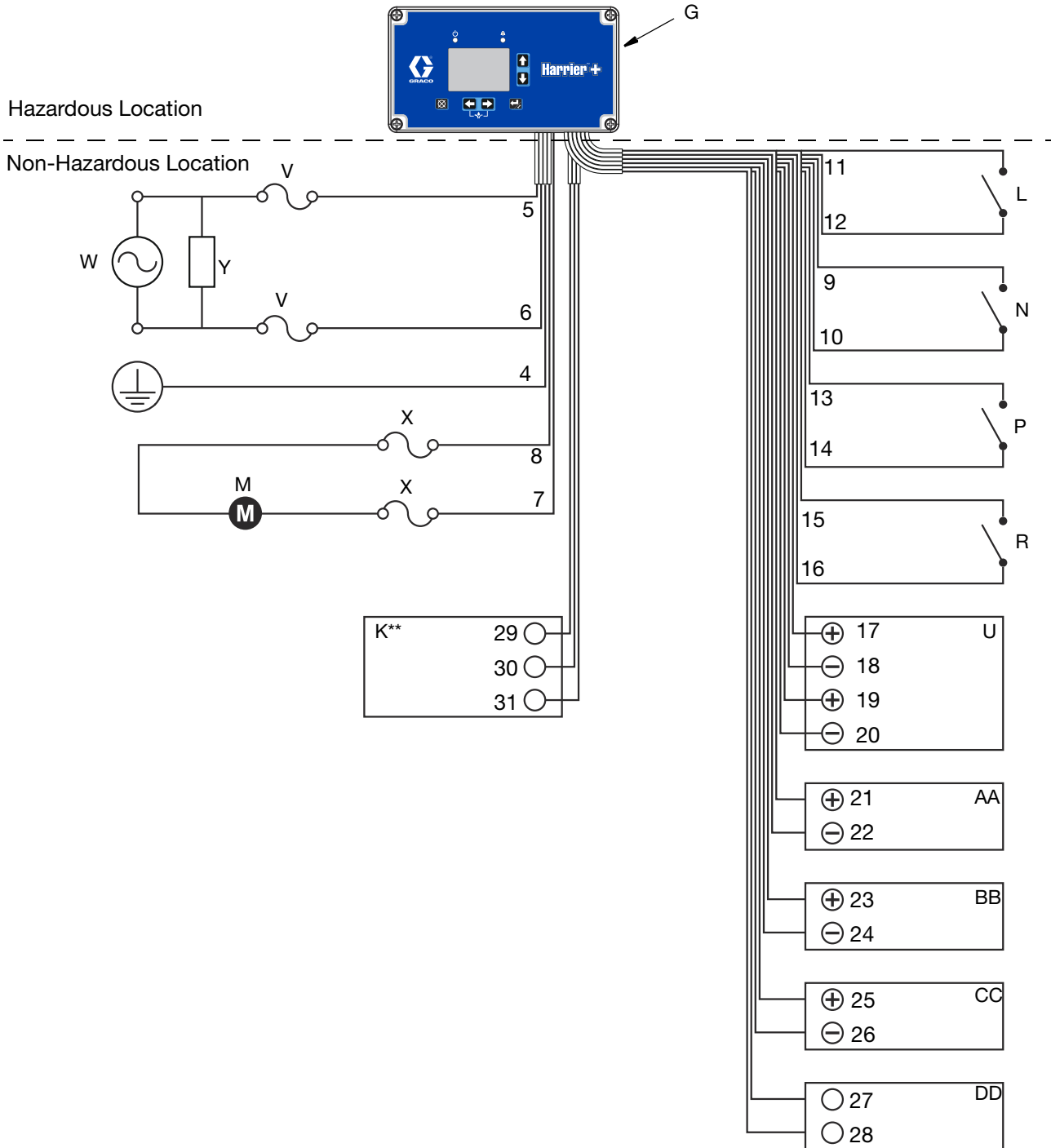

FIG. 6: Typical 240 VAC Installation

Key:

| | |
|-----------|-----------------------------------------------------------------|
| G | Controller |
| K | RS232 SCADA Interface** (optional, SCADA models only) |
| L | Auxiliary Switch (optional) |
| M | Pump Motor |
| N | Cycle Counter for System Control |
| P | Alarm Input #1 (optional) |
| R | Alarm Input #2 (optional) |
| U | Pressure Transducer (optional) |
| V | In-line Breaker (line) - UL 489, Class CC approved, 3A max (AC) |
| X | In-line Breaker (line) - UL 489, Class CC approved, 3A max (AC) |
| Y | Surge Protection Device*** |
| Z | Line Power (240 VAC) |
| AA | Tank Level Monitor (optional) |
| BB | Analog In (optional) |
| CC | Analog Out (optional) |
| DD | Temperature Probe (optional) |

** RS232 communication is available on SCADA models.
Gateway adapters to the controller's RS232 interface must be provided by user to support other protocols.

*** Type 1, Maximum recommended clamping voltage:
Line-Line: 1500V
Line-Neutral: 1000V
Max surge current $\geq 25kA$
(Required for CE)

240 VAC Wiring Diagram

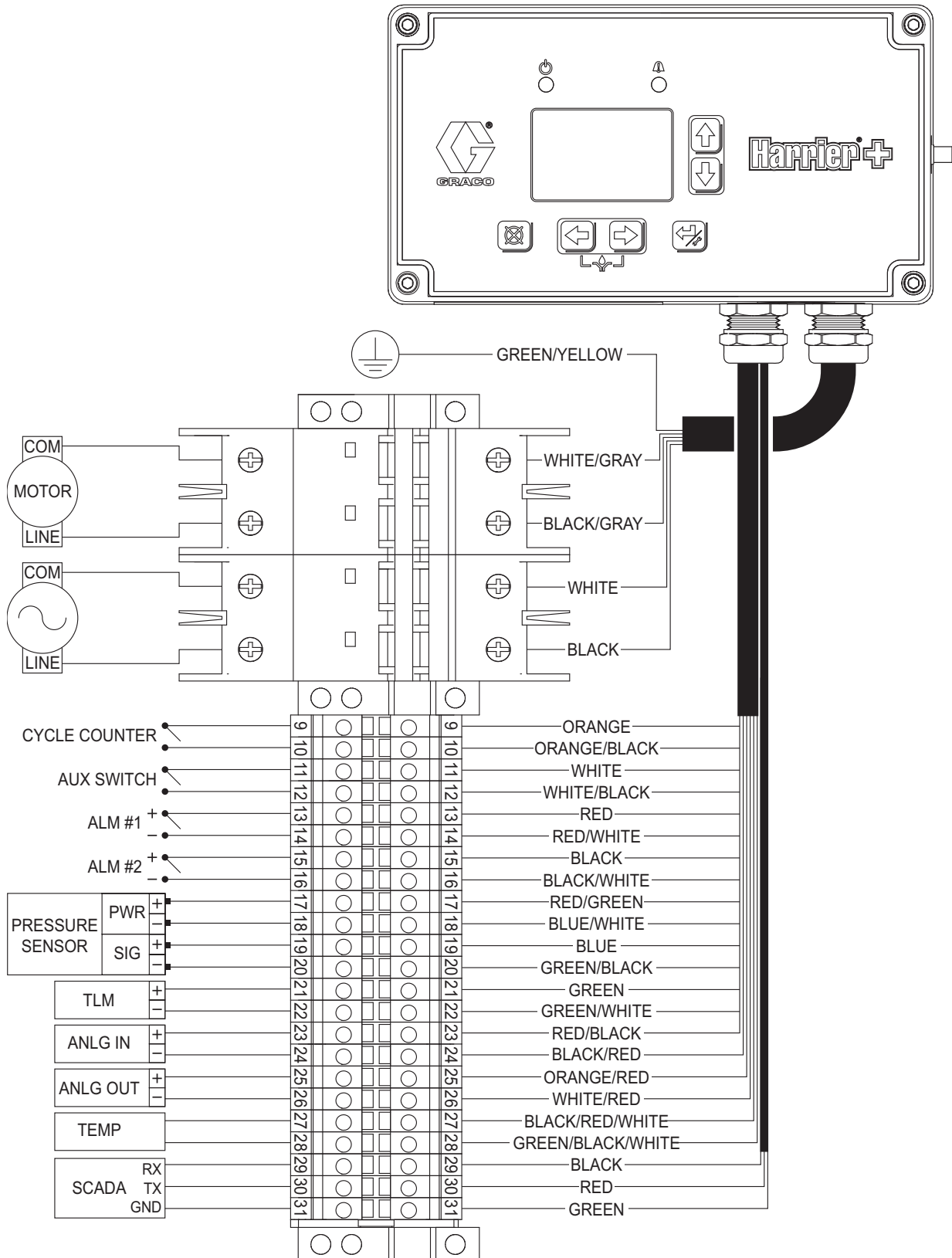

Fig. 7: 240 VAC Wiring Diagram

Wiring Key:

| | | |
|-----------|--------------------------------|-------------------|
| B1 | Motor COM Breaker | white/gray |
| B2 | Motor LINE Breaker | black/gray |
| B3 | AC COM Breaker | white |
| B4 | AC LINE Breaker | black |
| 4 | Earth Ground | green/yellow |
| 5 | Controller (LINE) | black |
| 6 | Controller (COM) | white |
| 7 | Pump Motor (LINE) | black/gray |
| 8 | Pump Motor (COM) | white/gray |
| 9 | Cycle Counter (+) | orange |
| 10 | Cycle Counter (-) | orange/black |
| 11 | Auxiliary Switch (+) | white |
| 12 | Auxiliary Switch (-) | white/black |
| 13 | Alarm #1 (+) | red |
| 14 | Alarm #1 (-) | red/white |
| 15 | Alarm #2 (+) | black |
| 16 | Alarm #2 (-) | black/white |
| 17 | Pressure Transducer Power (+) | red/green |
| 18 | Pressure Transducer Power (-) | blue/white |
| 19 | Pressure Transducer Signal (+) | blue |
| 20 | Pressure Transducer Signal (-) | green/black |
| 21 | Tank Level Monitor (+) | green |
| 22 | Tank Level Monitor (-) | green/white |
| 23 | Analog In (+) | red/black |
| 24 | Analog In (-) | black/red |
| 25 | Analog Out (+) | orange/red |
| 26 | Analog Out (-) | white/red |
| 27 | Temperature Probe | black/red/white |
| 28 | Temperature Probe | green/black/white |
| 29 | SCADA (RX) | black |
| 30 | SCADA (TX) | red |
| 31 | SCADA (GND) | green |

Wiring Diagrams

Analog In Powered Wiring

Installation instructions for connecting the ANALOG IN signal to a powered 4-20mA device where the device provides power.

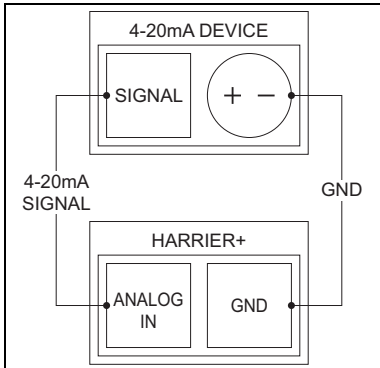

Fig. 8: Loop Diagram, Device Provides Power

Some 4-20mA devices are powered, as shown in FIG. 8. For powered devices, only the 4-20mA in/out signal needs to be connected to the analog input on the Harrier+, and the other process signal loop wire connects to GND.

Disconnect power to the controller and motor before wiring anything.

1. Connect the positive terminal of the device supplying the signal to terminal 24 "Analog In (-)".
2. Connect the negative terminal of the device supplying the signal to terminal 26 "Analog out (-)" (an unused GND).

Wiring Key:

| | | |
|----|----------------------|-----------|
| 24 | Analog In (-) | black/red |
| 26 | Analog Out (-) / GND | white/red |

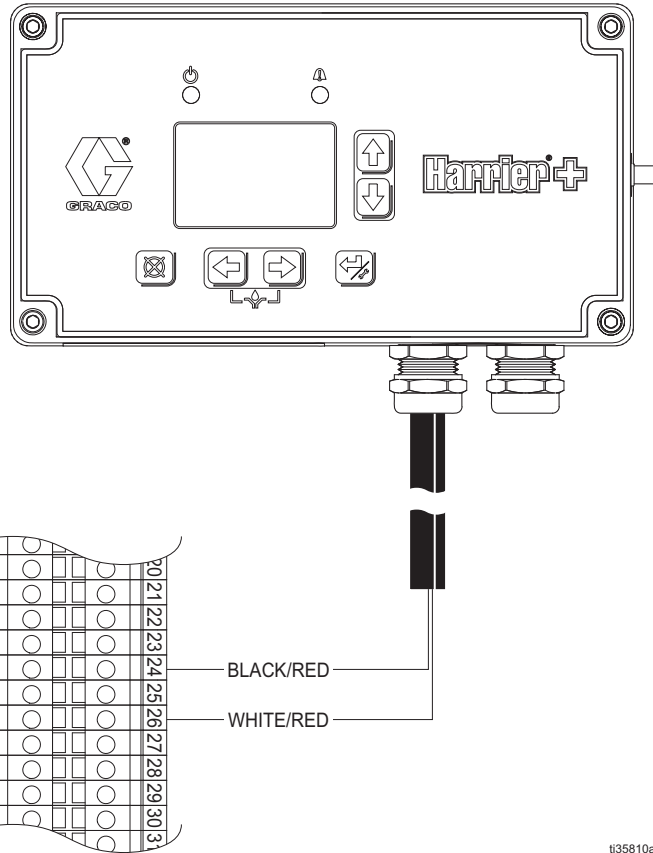

Fig. 9: Powered Device, use terminals 24 and 26

1135810a

Analog In Non-Powered Wiring

Installation instructions for connecting the ANALOG IN signal to a non-powered 4-20mA device where the Harrier+ provides power.

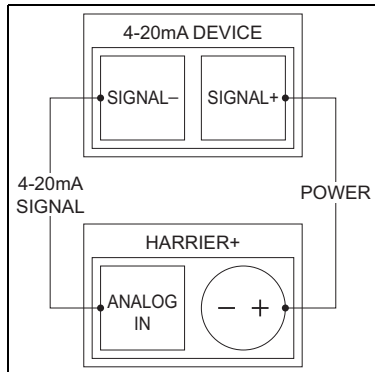

FIG. 10: Loop Diagram, Harrier+ Provides Power

Some 4-20mA devices are not powered and draw power from the process signal loop. For non-powered devices, the Harrier+ provides 24V on the Analog In (+) terminal to the device's signal+ line. The device's signal- line is then connected to the Harrier+ Analog In (-) terminal.

Disconnect the power to the controller and motor before wiring anything.

1. Connect the signal + terminal of the device supplying the signal to terminal 23 "Analog In (+)" (24V).
2. Connect the signal - terminal of the device supplying the signal to terminal 24 "Analog In (-)" (signal input).

Wiring Key:

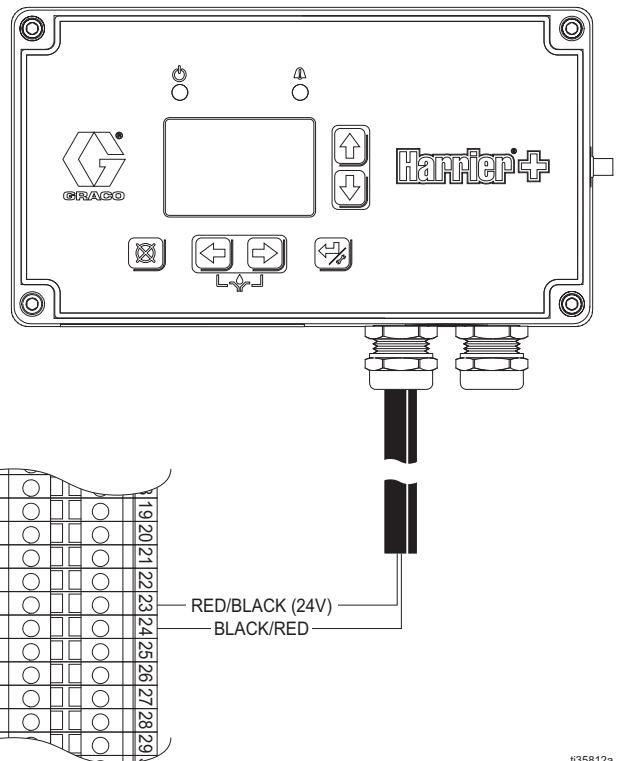

| | | |
|----|---------------------|-----------|
| 23 | Analog In (+) / 24V | red/black |
| 24 | Analog In (-) | black/red |



i35812a

FIG. 11: Non-Powered Device, use terminals 23 and 24

Analog Out DC Pump Wiring With Kit (B33006)

| | | | | |
|----------------------------------------------------------------------------------------------------------------------------------------------------------------------------|-----------------------------------------------------------------------------------|--|--|--|
|  |  | | | |
| <p>For remote operation of these products in a Class I, Division 2, Groups A, B, C, or D hazardous environment, please review your local safety rules and regulations.</p> | | | | |

DC Motor Only - Installation instructions for connecting the ANALOG OUT signal to a DC variable speed motor using Kit B33006.

1. Disconnect power to the variable speed Wolverine Motor.
2. Remove the motor junction box cover.
3. Remove the potentiometer knob and 8-pin white connector wire harness assembly, connected to J4, shown in FIG. 12.
4. Use the B33006 kit supply's plug to seal the hole in the junction box left behind by removing the potentiometer knob. See FIG. 13.
5. Connect the B33006 wiring harness 8-pin white connector into the variable speed board on J4.
6. Connect the 3-wire yellow stackable spade connector from J4 to the variable speed board PCOM terminal.
7. Connect pump motor(-) (8) from the Harrier+ terminal block to the yellow stackable spade connector at the variable speed board PCOM terminal.
8. Connect pump motor(+) (7) from the Harrier+ terminal block to the variable speed board +VM terminal.
9. Connect the single wire on the B33006 wiring harness to Analog Out(+) (25) on the Harrier+ terminal block.
10. Connect the variable speed board PCOM terminal to Analog Out (-) (26) on the Harrier+ terminal block.

NOTE: Units using an AC/DC converter between the controller and motor only:

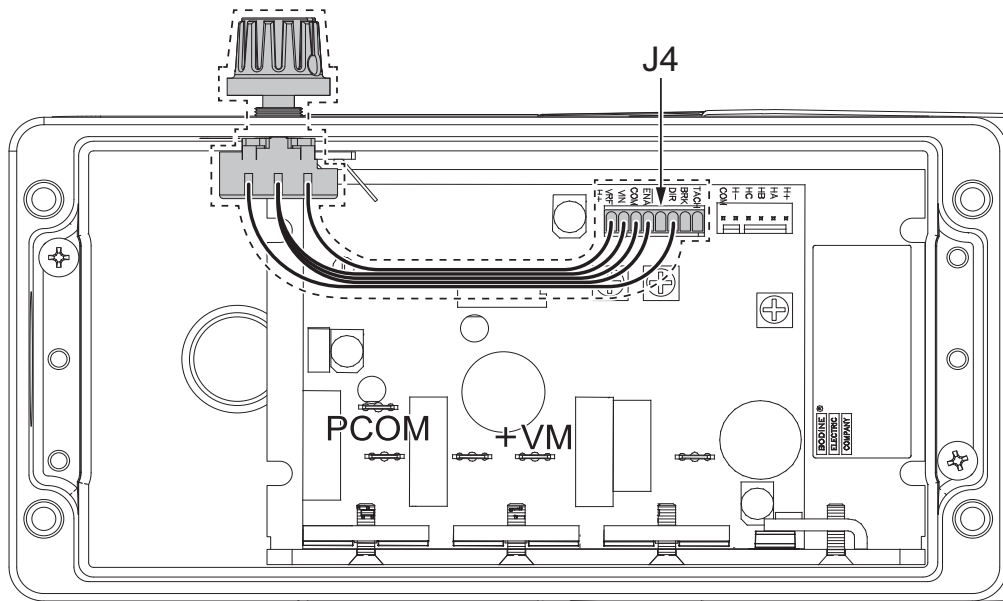
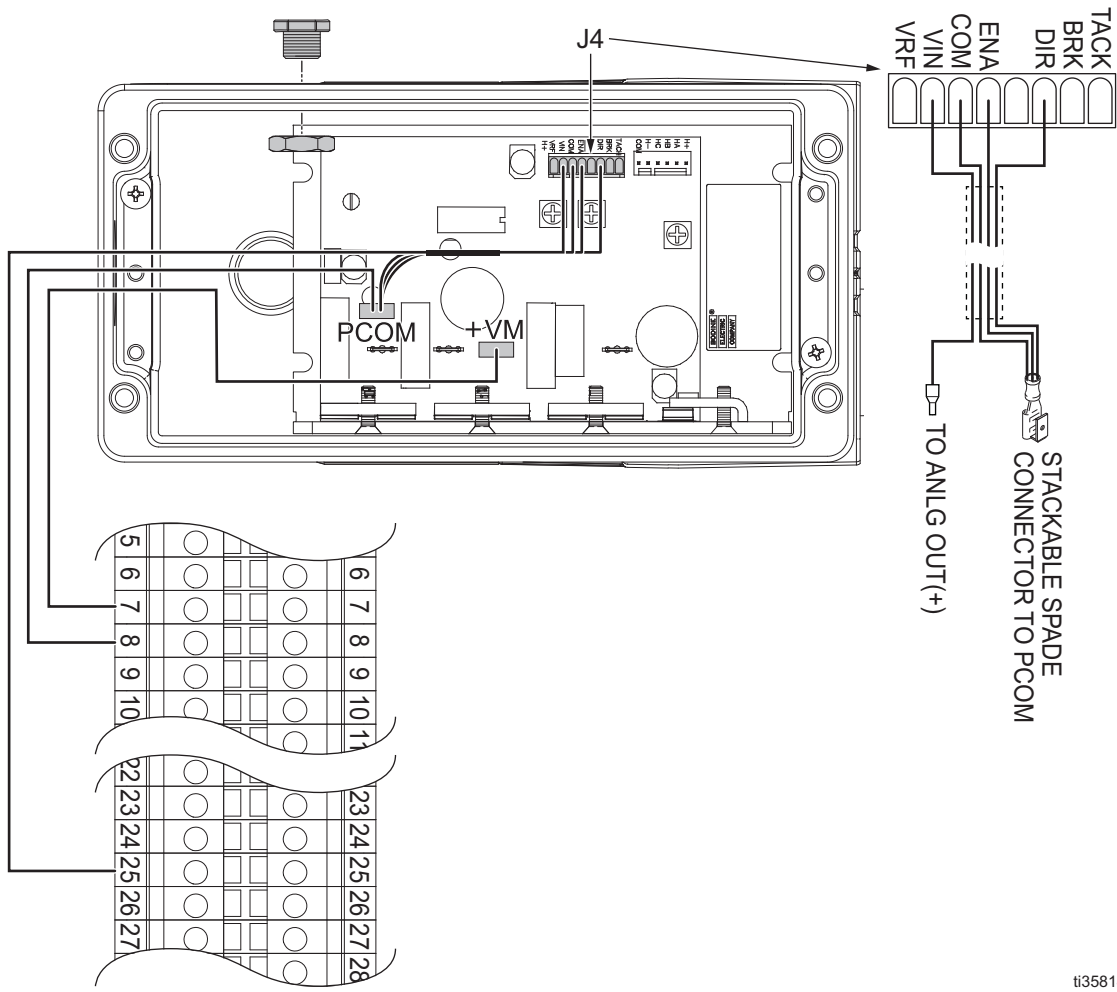

FIG. 12: Bodine DC Variable Speed Board with Potentiometer Knob



ti35814a

FIG. 13: DC Motor Only. Connect Harrier+ Analog Out to DC Variable Speed Motor with Kit B33006

Wiring Key:

| | | |
|----|----------------|------------|
| 7 | Pump Motor (+) | white |
| 8 | Pump Motor (-) | green |
| 25 | Analog Out (+) | orange/red |

Analog Out AC Pump Wiring With Bodine 3984 Isolation Board

120 VAC, AC Motor Only - Installation instructions for connecting the ANALOG OUT signal to an AC variable speed motor using the user supplied Bodine 3984 Isolation Board.

1. Disconnect the power and remove the motor control box cover.
2. Remove the potentiometer knob and wire harness assembly. See FIG. 14.
3. Plug the hole in the junction box left behind by removing the potentiometer knob with user supplied plug.
4. Connect Pump Motor (COM) and Pump Motor (LINE) from the Harrier+ terminal block to the variable speed control board L1 and L2 respectively. See FIG. 15.
5. Connect Analog Out (+)(25) and Analog Out (-)(26) from the Harrier+ terminal block to the 3984 isolation board VIN1 and ICOM respectively, on TB2. See FIG. 15.
6. Connect VOUT and COM on TB3 from the 3984 isolation board to the variable speed control board S1 and S2 respectively.
7. Supply 115 VAC power to the isolation board terminals on TB1.
8. Configure the switches, DSI, on the 3984 isolation board as shown in FIG. 15
9. Replace Motor Control Box Cover

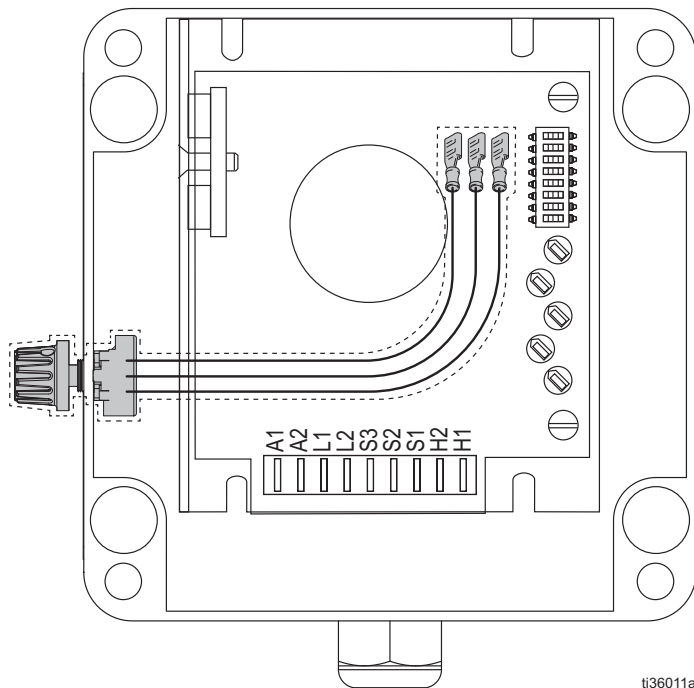
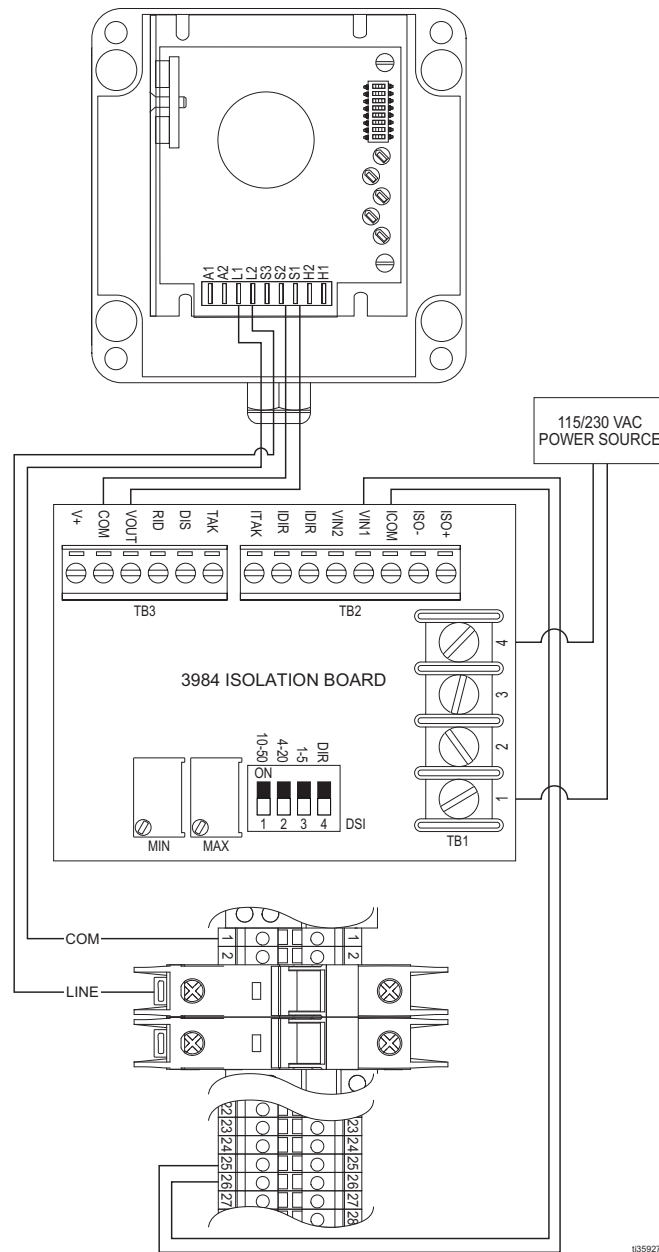

FIG. 14: Bodine AC Variable Speed Board with Potentiometer Knob

NOTE: Do not adjust the MAX and MIN potentiometers. The 3984 isolation board MIN and MAX potentiometers are factory adjusted to provide an output signal of 0 to 10 VDC out for a 0 to 10 signal on VIN, for example:
 0V in = 0V out
 5V in = 5 V out
 10V in = 10V out

Changing these potentiometers could change the voltage it supplies to the variable speed motor to incorrect values.



135927a

FIG. 15: AC 120 VAC Motor Only. Connect Harrier+ Analog Out To The DC Variable Speed Motor With An Isolation Board.

Wiring Key:

| | | |
|----|-------------------|------------|
| 1 | Pump Motor (COM) | black/gray |
| B1 | Pump Motor (LINE) | white/gray |
| 25 | Analog Out (+) | orange/red |
| 26 | Analog Out (-) | white/red |

Temperature Control Wiring

1. Mount the temperature sensor device lug or probe in the desired location. Lug Style (Kit B32989) or Probe Style (Kit B32131).
2. Connect the temperature sensor leads to terminals 27 and 28 on the din rail (polarity does not matter).

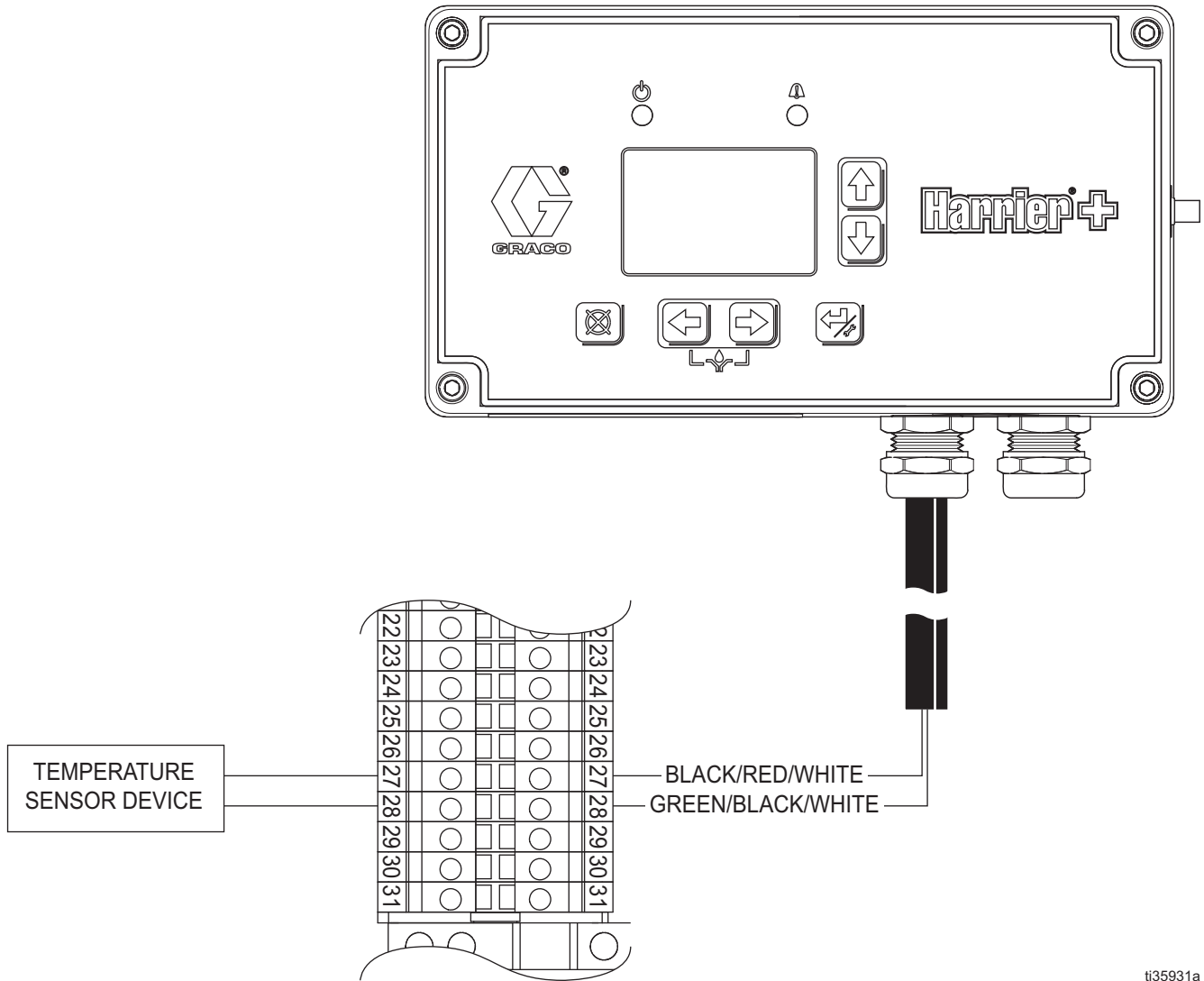

FIG. 16: Temperature Control Wiring

ti35931a

Wiring Key:

| | | |
|----|-------------------|-------------------|
| 27 | Temperature Probe | black/red/white |
| 28 | Temperature Probe | green/black/white |

SCADA Wiring for RS232 to RS485 Converter Kit (B32874)

This is an example of connecting a 2-wire RS485 device to a PLC. It uses the internal bias resistance of the converter and assumes that the external RS485 network provides its own termination resistance. Bias and termination settings may vary depending on the application, especially if multiple devices are connected. It's recommended to begin with the default switch settings shown and with just one Harrier+ connected until communication is established.

1. Connect the RX, TX, and GND wires on the supplied cable in Kit B32874 to the RX, TX, and GND Harrier+ terminal blocks (terminal numbers may vary). Cross the RX and TX lines, RX to TX and TX to RX on the din rail.
2. Connect the + and - power terminals on the converter to a 10-30V power source, such as the + and - battery terminals 2 and 4 respectively. AC systems must supply their own 10-30V power supply.
3. Connect the RS485 RDB (+), RDA (-), and GND terminals to the appropriate PLC inputs.
4. Keep the 8-Position DIP switches on the back of the converter in their default configuration, as shown.

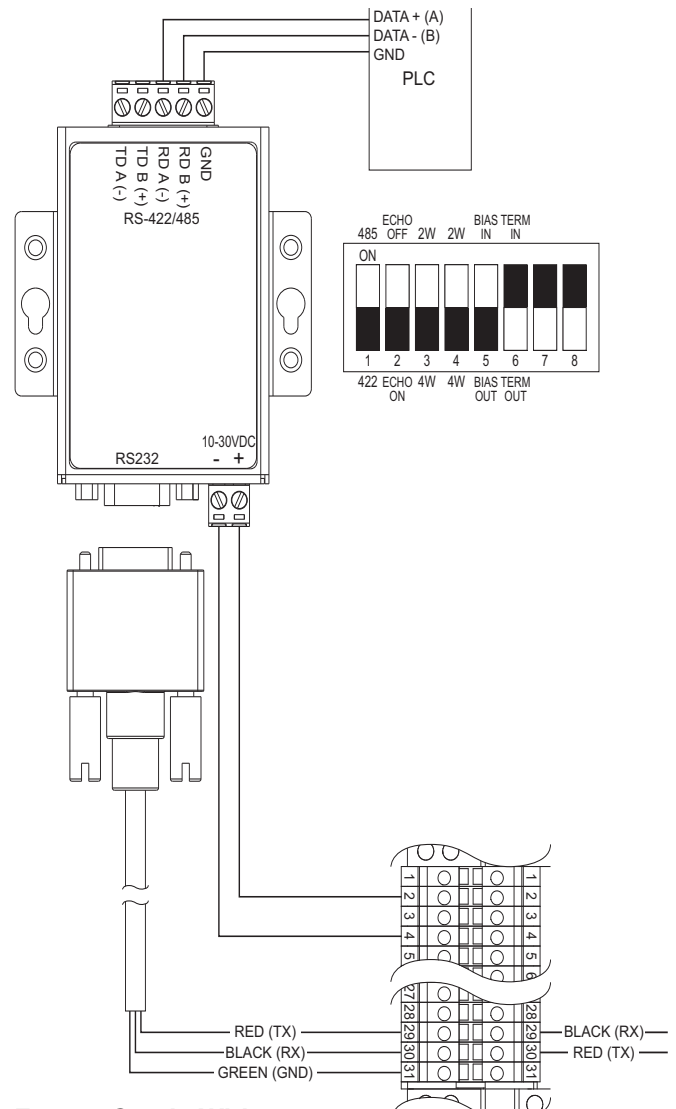

FIG. 17: Scada Wiring

Wiring Key:

| | | |
|----|----------------------|------------|
| 2 | Battery Monitor (+)* | blue/red |
| 4 | Battery Monitor (-)* | blue/black |
| 29 | Scada (Rx) | black |
| 30 | Scada (Tx) | red |
| 31 | Scada (GND) | green |

*AC Systems must supply their own 10-30V Power Supply

Theory of Operation

Flow Control Summary

In Flow mode, you can choose a target flow rate, in gallons or liters per day, and the controller will determine how long it needs to run the pump to hit that flow rate. The maximum volume that can be pumped each day is determined by the pump's plunger diameter and stroke length and is represented as the K-Factor. The K-Factor can be dialed in during calibration for maximum accuracy.

Flow mode is advantageous when maximum accuracy is required. It is the most accurate mode because it can be precisely calibrated and compensates for changes in the application such as well pressure and battery voltage.

Cycle Control Summary

In Cycle mode, you can choose the number of cycles the pump runs for and the off time. A cycle is a single rotation of the pump cam, as detected by the cycle switch.

Cycle mode is advantageous when accuracy is required without having to calibrate the system. It provides assurance that an exact number of cycles are dispensed before the pump stops for the duration of the off time. Although not required, it's recommended to use a calibration column to verify the volume dispensed.

Time Control Summary

In Time mode, you can choose the on time and off time. Adjusting the on and off times allows the user to control both the dosing of chemical along with the frequency at which the pump runs.

Time mode is advantageous when direct control of the pump's run time is required.

Pump Calibration

The pump should be calibrated to ensure the accuracy of the actual flow rate and totalizers. The totalizers are reported on the Web portal in Flow Mode.

Calibration Column Method

This method requires the user to provide a calibration column that can be isolated from the tank. Fluid is pumped from the column and measured to dial in the K-Factor. It's the most accurate method for dialing in the K-Factor and is required to run a pump in flow mode. See kit B32088 or B32208.

Set up the controller in Flow Mode by following steps 1-18 on the **Pump Setup Screen (Flow Mode)**, page 31, and complete the Calibration Column Method, page 33, described in steps 19-25.

If desired, a calibration column can also be used to verify the volume dispensed after setting up the controller in Cycle Mode (See **Pump Setup Screen (Cycle Mode - Harrier+ Standard Models only [B326xx])**, page 37).

Beaker Method

This method requires the user to provide an appropriately sized beaker based on the size and flow rate of the pump. Fluid is dispensed into the beaker and measured to automatically calculate an estimated K-Factor for increased injection accuracy. It is only intended for use in low pressure applications where the pressure is at or near 0 psi.

Set up the controller in Flow Mode by following steps 1-18 on the **Pump Setup Screen (Flow Mode)**, page 31, and replace the calibration column steps 19-25 with the Beaker Calibration procedure, initiated on the Advanced Setup Screen (See **Beaker Calibration Method**, page 47).

Controller Setup

| | | | | |
|--------------------------------------------------------------------------------------------------------------|--|--|--|--|
| | | | | |
| AUTOMATIC SYSTEM ACTIVATION HAZARD | | | | |
| Unexpected activation of the system could result in serious injury, including skin injection and amputation. | | | | |
| This device can automatically dispense fluid as soon as it is returned to the Run screen (see page 53). | | | | |

Configuration Screen

When you first turn on power to the Injection Controller, the following identification screen displays.



FIG. 18: Splash screen

AA The current Software Version

NOTE: The backlight is on at power-up and will turn off after 30 seconds if no button is pressed.

1. To access the Configuration screen, press and hold the Enter key for 3 seconds.

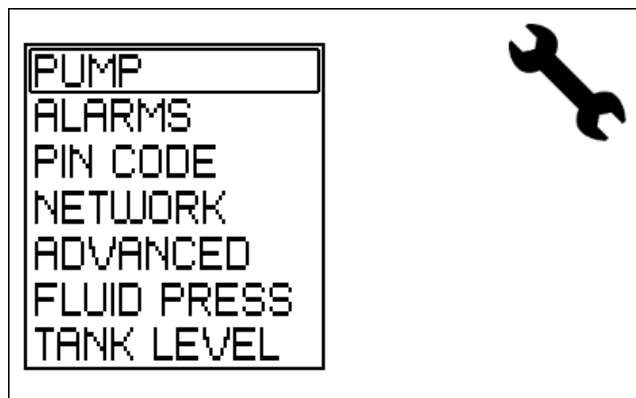
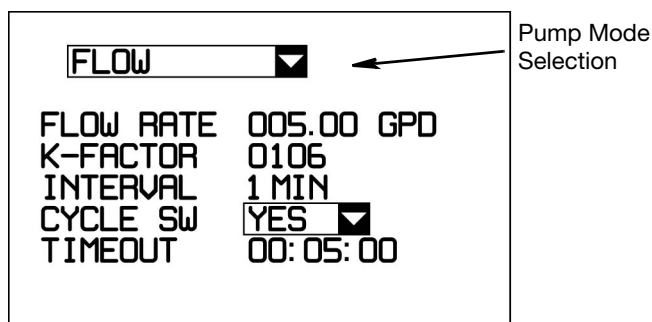

FIG. 19: Configuration screen

2. Use the Up/Down arrows to move the cursor up and down through the list of setup screens, and press Enter to display the selected setup screen.
3. When all setup operations are complete, press Reset to return to normal operation.

Pump Setup Screen (Flow Mode)



ti02084a

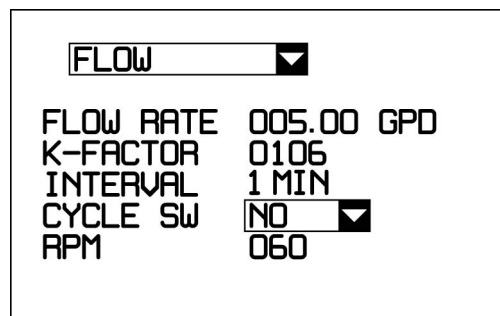

ti02085a

FIG. 20: Pump Setup screen (Flow mode)

The Pump Setup (Flow Mode) screen is used to set the following:

- **FLOW RATE** - The desired number of gallons or liters to be pumped per day (600 GPD/2,271 LPD Max).
- **K-FACTOR** - A coefficient representing the amount of fluid that can be dispensed depending on plunger size.
- **INTERVAL** - The length of the pump's On/Off cycle. Use longer intervals for low flow rates.

- **TIMEOUT** - An alarm is triggered if a cycle is not detected within the time specified in the TIMEOUT field. It resets whenever a cycle is detected. Only available if CYCLE SW = YES.
- **CYCLE SW** - Select NO and enter RPM's if there isn't a reed switch on the pump or select YES and enter timeout if there's a reed switch on pump.
- **RPM** - The RPM rating of the pump, found either on the pump nameplate or by counting and timing actual RPM's. Only available if CYCLE SW = NO.

NOTE: Pumps with reed switches will be more accurate than those without

If running a pump without a reed switch, enter the RPM's from the pump nameplate. The totalizer (FLOW MODE only) for CELL or SCADA units will be inaccurate if the RPM value entered is incorrect. For increased accuracy, count the revolutions per minute with a stop watch and enter the number of RPMs counted in one minute.

Initial Setup and K-Factor Calibration

1. Wait for the pump to be in the off portion of a cycle and display the **Configuration Screen** on page 31.

NOTE: If you access the Configuration screen while the pump is running, the accuracy of the calibration will be reduced. If this is a new install, the controller will display the Configuration screen by default.
2. Highlight PUMP and press Enter to display the Pump Setup Screen.
3. Use the Up/Down arrows to move the cursor to the Pump Mode Selection box and press Enter to display the list of mode options.
4. Use the Up/Down arrows to highlight FLOW and press Enter to display the Flow Mode fields for Harrier+ standard models (B326xx).

5. Highlight the FLOW RATE field, and press Enter.
 - Harrier+ standard models (B326xx) proceed to Step 6.
 - Harrier+ MPI models (B328xx) display the Multiple Point Injection Setup Screen.



FIG. 21: Multiple Point Injection screen

- a. Set the MPI ENABLE field to DISABLED mode.
 - b. Use the arrow keys to highlight and select values for each digit in the desired GPD (gallons per day or LPD (liters per day) value.
 - c. Verify the desired value is displayed in the FLOW RATE field, and press Enter.
 - d. Press the Reset key to return to the Pump Setup Screen and proceed to Step 8.
6. Use the arrow keys to highlight and select values for each digit in the desired GPD (gallons per day) or LPD (liters per day) value.
 7. Verify the desired value is displayed in the FLOW RATE field, and press Enter.
 8. Identify the estimated K-Factor from the table below. You may interpolate between values in the table.

| Wolverine/ G-Chem Pumps | | | |
|--------------------------------|---------------|-----------------|---------------|
| Plunger Diameter | Stroke | K-Factor | |
| | | Simplex | Duplex |
| 3/16 in. | 1/4 in. | 30 | 60 |
| | 1/2 in. | 60 | 120 |
| | 3/4 in. | 90 | 179 |
| | 1 in. | 120 | 239 |
| 1/4 in.* | 1/4 in. | 53 | 106 |
| | 1/2 in.* | 106 | 212 |
| | 3/4 in.* | 159 | 319 |
| | 1 in.* | 212 | 425 |
| 3/8 in.* | 1/4 in. | 120 | 239 |
| | 1/2 in.* | 239 | 478 |
| | 3/4 in.* | 359 | 717 |
| | 1 in.* | 478 | 956 |
| 1/2 in.* | 1/4 in. | 212 | 425 |
| | 1/2 in.* | 425 | 850 |
| | 3/4 in.* | 637 | 1275 |
| | 1 in.* | 850 | 1700 |
| 5/8 in. | 1/4 in. | 332 | 664 |
| | 1/2 in. | 664 | 1328 |
| | 3/4 in. | 996 | 1992 |
| | 1 in. | 1328 | 2656 |
| 3/4 in. | 1/4 in. | 478 | 956 |
| | 1/2 in. | 956 | 1912 |
| | 3/4 in. | 1434 | 2869 |
| | 1 in. | 1912 | 3825 |

*Available on G-Chem Pumps

| Wolverine DA Pumps | |
|---------------------------|-----------------|
| Plunger Diameter | K-Factor |
| 3/8 in. | 850 |
| 1/2 in. | 1910 |
| 3/4 in. | 4307 |
| 1 in. | 6428 |

9. Use the arrow keys to highlight and select values for each digit in the K-FACTOR value.

10. Verify the desired value is displayed in the K-FACTOR field, and press Enter.
11. Highlight the INTERVAL field, and press Enter.
12. Highlight the 1 MIN interval and press Enter. This will set a 1-minute cycle interval to match the calibration column.
13. Highlight CYCLE SW and select YES (See step 14.) if the switch is present or NO if the switch is not present (See step 16.)
14. If the switch is present, highlight the TIMEOUT field, and press Enter.
15. Use the arrow keys to highlight and select values for each digit in the HH:MM:SS format. This timer runs during the pump On cycle, and will reset whenever a cycle is detected. When setting this value, allow enough time for at least one cycle to complete.
16. If switch is not present, enter the RPM value.
17. Verify the desired value is displayed in the TIMEOUT field or RPM, and press Enter.
18. Press Reset to return to the Configuration screen.

Calibration Column Method

The calibration column method is described in steps 19-25.

19. Fill calibration column and close tank supply. Note the level of the fluid in the calibration column.
20. Note the starting fluid level of the calibration column.
21. Press Reset to resume pump operation.
22. If this is a new install, the pump will begin pumping immediately. Otherwise, press the Left and Right buttons simultaneously to start the pump.
23. Note the finishing fluid level of the calibration column.
24. Calculate the difference between the starting and ending fluid levels. If the calibration column is in units of gallons per hour (GPH) or liters per hour (LPH), convert to GPD or LPD by multiplying by 24.

25. Compare the calibration column value with the desired flow rate.
 - a. If the calibration column indicates the system **over-pumped, increase** the K-FACTOR:
 - i - Repeat Step 1.
 - ii - Repeat Step 9, increasing the K-FACTOR field. Press Enter.
 - iii - Repeat Steps 16-22 until the calibration column matches the desired flow rate.
 - b. If the calibration column indicates the system **under-pumped, decrease** the K-FACTOR:
 - i - Repeat Step 1.
 - ii - Repeat Step 9, decreasing the K-FACTOR field. Press Enter.
 - iii - Repeat Steps 16-22 until the calibration column matches the desired flow rate.

NOTE 1: If the desired flow rate causes the pump to not complete a full revolution of the cam in the short interval set in Step 12, temporarily increase the flow rate in Step 6. After Step 22, you will have the correct K-Factor and can change back to the desired flow rate and change the INTERVAL field to a longer interval, verifying the pump completes at least 1 full rotation of the cam when running.

NOTE 2: If the desired flow rate is higher than the calibration column can read, temporarily decrease the flow rate in Step 6 to a value the column can read. After Step 22, you will have the correct K-Factor and can change back to the desired flow rate.

NOTE 3: You can follow the **Beaker Calibration Method**, see page 47, to replace Steps 19-25.

Harrier+ Standard Models (B326xx) FLOW RATE Setup

1. Access the Configuration screen, press and hold the Enter key for 3 seconds
2. Highlight PUMP and press Enter to display the Pump Setup screen
3. Use the Up/Down arrows to move the cursor to the Pump Mode Selection box, select FLOW, and press Enter to display the list of mode options
4. Highlight the FLOW RATE field, and press Enter
5. Use the arrow keys to highlight and select values for each digit in the desired GPD (gallons per day) or LPD (liters per day)
6. Verify the desired value is displayed and press Enter

Harrier+ MPI Models (B328xx) FLOW RATE Setup

1. Access the Configuration screen, press and hold the Enter key for 3 seconds
2. Highlight PUMP and press Enter to display the Pump Setup screen
3. Use the Up/Down arrows to move the cursor to the Pump Mode Selection box, select FLOW, and press Enter to display the list of mode options
4. Highlight the FLOW RATE field, and press Enter. (See FIG. 21.)

5. Select MPI ENABLE Selection box and press Enter to display the list of mode options. (See FIG. 22.)

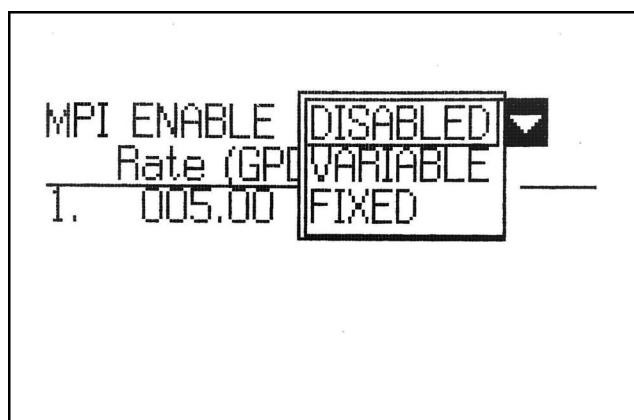

FIG. 22: Multiple Point Injection screen

- **DISABLED** - Single point injection
- **VARIABLE** - Compatible with variable-speed pumps only, using the Analog Out function, found on pages 24 and 26, and the B33006 Analog Out Wiring Kit (DC only). The pump will run continuously, injecting into each point individually, and the controller will speed up and slow down depending on the FLOW RATE setting.
- **FIXED** - Compatible with fixed and variable-speed pumps. Pump will run for a period of time injecting into each point individually and then remain off for a period of time depending on the FLOW RATE settings. This mode is suggested for solar application.

6. Highlight the desired mode and press Enter. (See FIG. 23.)

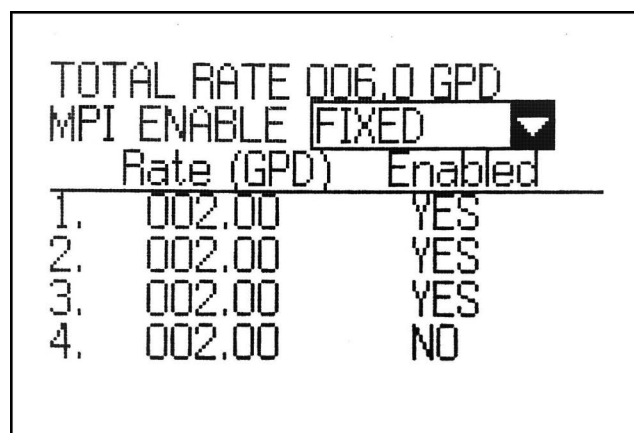

FIG. 23: Multiple Point Injection screen

7. Use the down arrow key to highlight the RATE value and press Enter.
8. Use the arrow keys to highlight and select values from each digit in the desired GPD (gallons per day) or LPD (liters per day).
9. Verify the desired value is displayed and press Enter.
10. Select YES and press Enter to enable the injection point.
11. Continue setting rates for up to eight points. Use the down arrow to display points 5 - 8.
12. Press the Reset key to return to the Pump Setup Screen.

NOTE: The TOTAL RATE will be displayed at the top of the screen for all enabled points.

Prime Sequence

Harrier+ Standard Models (B326xx)

1. Hold down the Left and Right arrows simultaneously to start the priming sequence.
2. The pump will continue to run until the Reset key is pressed.

Harrier+ MPI Models (B328xx)

1. Hold down the Left and Right arrows simultaneously to start the priming sequence.
2. The pump will continue to run starting with the first active solenoid. (See FIG. 24.) The active solenoid will be displayed on the screen.

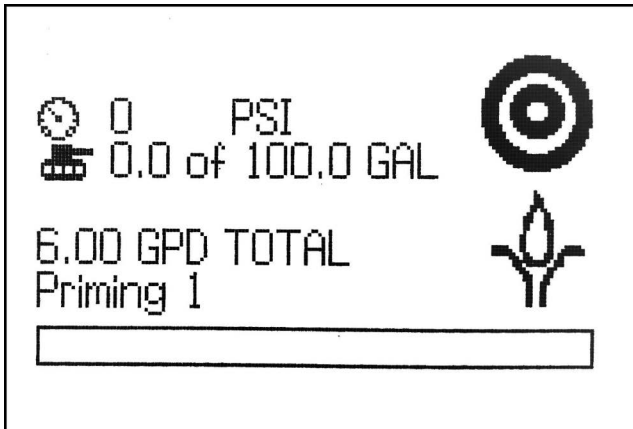

FIG. 24: Multiple Point Injection Priming screen

3. Press the Enter key to activate the next solenoid in the sequence.
4. Continue until all solenoids are primed.
5. Press the Reset key at any time during the priming setup to stop.

Pump Setup Screen (Time Mode - Harrier+ Standard Models only [B326xx])

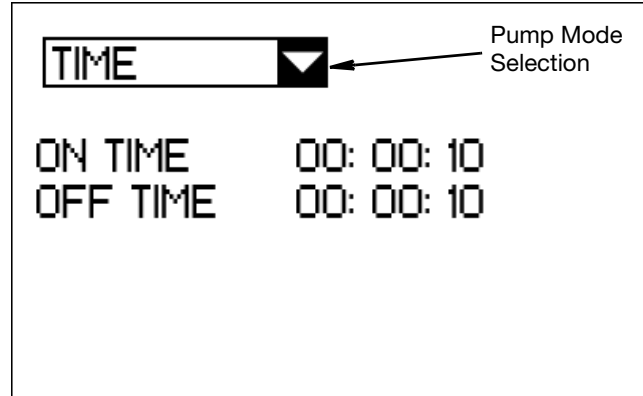

FIG. 25: Pump Setup screen (Time mode)

The Pump Setup (Time Mode) screen is used to set the following:

- **ON TIME** - The desired amount of time the pump is to remain on.
- **OFF TIME** - The desired amount of time the pump is to remain off.

1. On the **Configuration Screen**, page 31, highlight PUMP and press Enter to display the Pump Setup screen.
2. Use the Up/Down arrows to move the cursor to the Pump Mode Selection box and press Enter to display the list of mode options.
3. Use the Up/Down arrows to highlight TIME and press Enter to display the Time Mode fields.
4. Highlight the ON TIME field, and press Enter.
5. Use the arrow keys to highlight and select values for each digit in the HH:MM:SS format.
6. Verify the desired value is displayed in the ON TIME field, and press Enter.
7. Repeat steps 4-6 for the OFF TIME field.
8. Press Reset to return to the Configuration screen.

Pump Setup Screen (Cycle Mode - Harrier+ Standard Models only [B326xx])

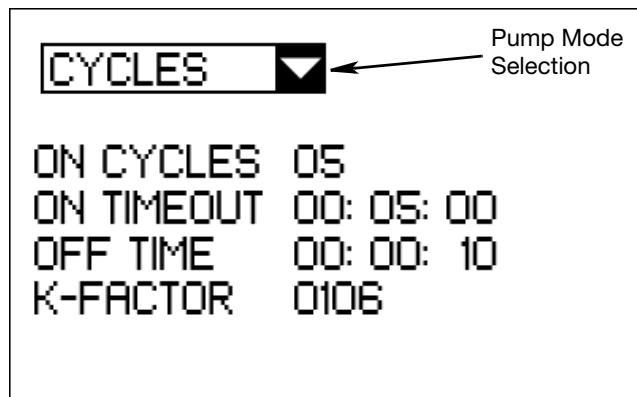

Fig. 26: Pump Setup screen (Cycle mode)

The Pump Setup (Cycle Mode) screen is used to set the following:

- **ON CYCLES** - The desired number of cycles the pump is to remain on. A cycle is defined as a single rotation of the pump cam, as detected by the cycle switch.
- **ON TIMEOUT** - An alarm is triggered if a cycle is not detected within the time specified in the ON TIMEOUT field. It resets whenever a cycle is detected. This timer starts when the value in the OFF TIME field expires.
- **OFF TIME** - The desired amount of time the pump is to remain off after the desired number of cycles in the ON CYCLES field have completed.
- **K-FACTOR** - See **Pump Setup Screen (Flow Mode)** on page 31.

1. On the **Configuration Screen**, page 31, highlight PUMP and press Enter to display the Pump Setup screen.
2. Use the Up/Down arrows to move the cursor to the Pump Mode Selection box and press Enter to display the list of mode options.
3. Highlight CYCLES and press Enter to display the Cycle Mode fields.
4. Highlight the ON CYCLES field, and press Enter.

5. Use the arrow keys to highlight and select values for each digit.
6. Verify the desired value is displayed in the ON CYCLES field, and press Enter.
7. Highlight the ON TIMEOUT field, and press Enter.
8. Use the arrow keys to highlight and select values for each digit in the HH:MM:SS format. This timer runs during the pump On cycle, and will reset whenever a cycle is detected. When setting this value, allow enough time for at least one cycle to complete.
9. Verify the desired value is displayed in the ON TIMEOUT field, and press Enter.
10. Repeat steps 7-9 for OFF TIME field.
11. Highlight the K-FACTOR field, and press Enter.
12. Use the arrow keys to highlight and select values for each digit in the desired K-Factor.
13. Verify the desired value is displayed in the K-FACTOR field, and press Enter.
14. Press Reset to return to the Configuration screen.

Alarms Setup Screen

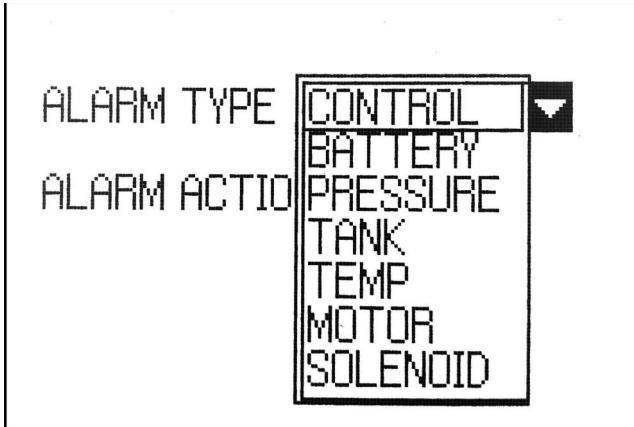

FIG. 27: Alarm Setup Screen, Alarm Action items (MPI models only)

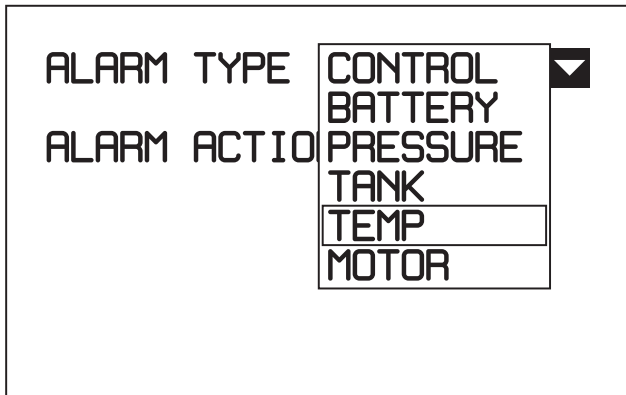

FIG. 28: Alarm Setup Screen, Alarm Type Items

- **ALARM TYPE** - Highlight alarm type and press Enter to display related alarms.
 - CONTROL- See **Control Alarms**, page 39.
 - BATTERY - See **Battery Alarms**, page 39.
 - PRESSURE - See **Pressure Alarms**, page 40.
 - TANK - See **Tank Alarms**, page 40.
 - TEMP - See **Temperature Control Alarms**, page 41.
 - MOTOR - See **Motor Over Current Alarm**, page 42.
 - SOLENOID - See **Solenoid Alarms (Harrier+ MPI models only)**, page 43.

- **ALARM ACTION** - Specify the action to be taken when an alarm is triggered.
 - STOP - Stop the pump.
 - NOTIFY - Alarm is triggered, but pump continues running.

The table below shows which alarms the alarm action applies to and which ones are notify, alarm only, or signal events.

| Alarm Actions | | | |
|---------------------|------|-----------------------|--------------|
| Alarm Name | Stop | Notify | Signal Event |
| Input 1 | ✓ | ✓ | |
| Input 2 | ✓ | | |
| Remote Input | | | ✓ |
| High Pressure | ✓ | ✓ | |
| Low Pressure | ✓ | ✓ | |
| Counts Not Achieved | ✓ | ✓ (Flow Mode only) | |
| Low Battery | ✓ | | |
| Analog In | | ✓ | |
| Temperature | | | ✓ |
| Over Current | ✓ | | |
| Power Save Mode | | | ✓ |
| Modbus Comms | | ✓ | |
| Solenoid | | ✓ | |

Control Alarms

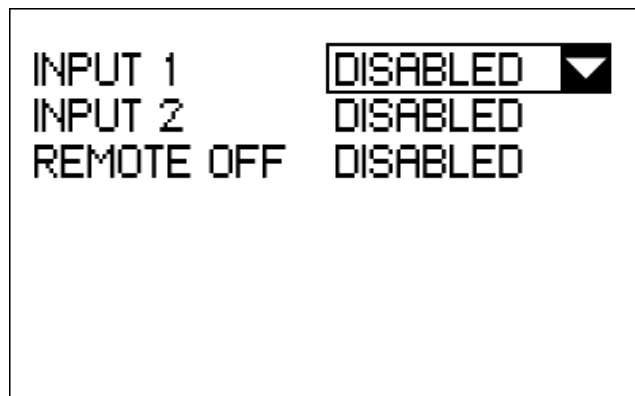

FIG. 29: Control alarms

- **INPUT 1** - Enable or disable a generic input alarm. When enabled, the alarm can be set for either normally closed or normally open switches. See **Alarms and Signal Events**, page 53.
- **INPUT 2** - Enable or disable a generic input alarm. When enabled, the alarm can be set for either normally closed or normally open switches. See **Alarms and Signal Events**, page 53.
- **REMOTE OFF** - Enable or disable a remote input event. When enabled, the alarm can be set for either normally closed or normally open switches. See **Alarms and Signal Events**, page 53.

Normally Open/Normally Closed Settings

Normally Open:

- For INPUT 1 & 2, triggers alarm when signal is high (switch open).
- For REMOTE OFF, puts pump into standby when signal is high (switch open).

Normally Closed:

- For INPUT 1 & 2, triggers alarm when signal is low (switch closed).
- For REMOTE OFF, puts pump into standby when signal is low (switch closed).

Battery Alarms

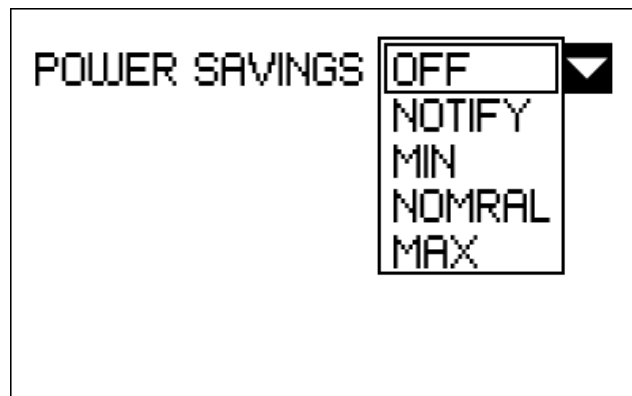

FIG. 30: Power savings selections

- **POWER SAVINGS** - Specifies the action taken by the controller when the pump enters Power Save mode. This is an optional feature that requires a battery monitor. (See **Typical 12 or 24 VDC Installation and Wiring**, page 10.)

NOTE: Harrier+ MPI models (B328xx) only -

When operating in multiple point injection (MPI) mode with a variable-speed motor, the Power Savings features will be notification-only.

Actions include:

- OFF - Turn Power Save mode Off.
- NOTIFY - Warns user of low battery, but does not reduce pump On time.
- MIN - Reduces pump On time to 75%.
Ex: If On Time = 60 seconds, the pump will only run for 45 seconds.
- NORMAL - Reduces pump On time to 50%.
Ex: If On Time = 60 seconds, the pump will only run for 30 seconds.
- MAX - Reduces pump On time to 25%.
Ex: If On Time = 60 seconds, the pump will only run for 15 seconds.

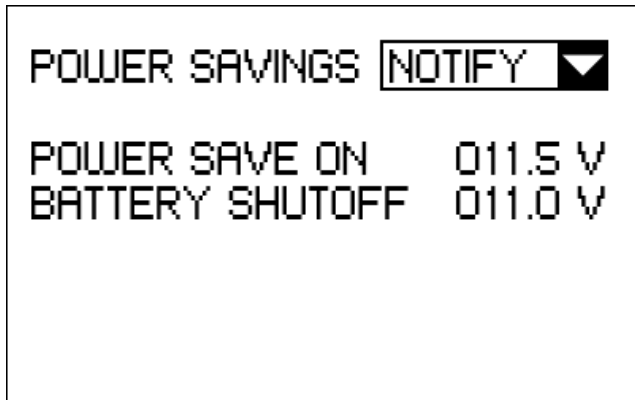

FIG. 31: Battery alarms

- **POWER SAVE ON** -The controller enters Power Save mode when battery voltage drops below the value specified. This field is not displayed when Power Save mode is Off. Setting a value here enables power save mode and the controller will perform the action specified in the power savings select box.
- **BATTERY SHUTOFF** - An alarm is activated when the battery voltage drops below the value specified. This field is not displayed when Power Save mode is Off.

Pressure Alarms

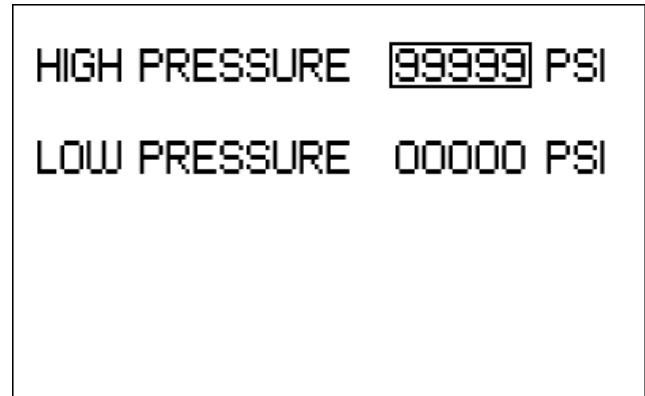

FIG. 32: Pressure Alarms

- **HIGH PRESSURE** - An alarm is activated when the pressure is higher than the value specified.
- **LOW PRESSURE** - An alarm is activated when the pressure is lower than the value specified.

Tank Alarms

This is an optional feature that requires a tank level monitor. Refer to the Tank Level Monitoring Kit manual (see **Related Manuals** on page 3).

Temperature Control Alarms

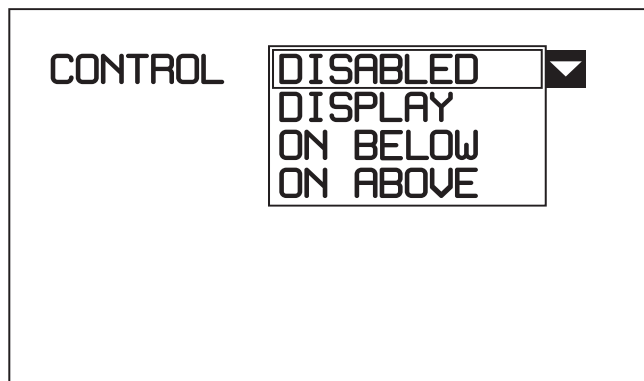

FIG. 33: Temperature Control Setup Screen

- **CONTROL** - Highlight type and press ENTER to display related alarms.
 - **DISABLED** - Disables reading and displaying temperature
 - **DISPLAY** - Display temperature on the run screen only, no pump control.
 - **ON BELOW** - Turn pump on below setpoint and display temp on run screen.
 - **ON ABOVE** - Turn pump on above setpoint and display temp on run screen
 - **SETPOINT** - The temperature at which the pump turns on at (-40°F to 118°F). Selecting ON ABOVE or ON BELOW enables temp control and will prompt user to enter the SETPOINT.

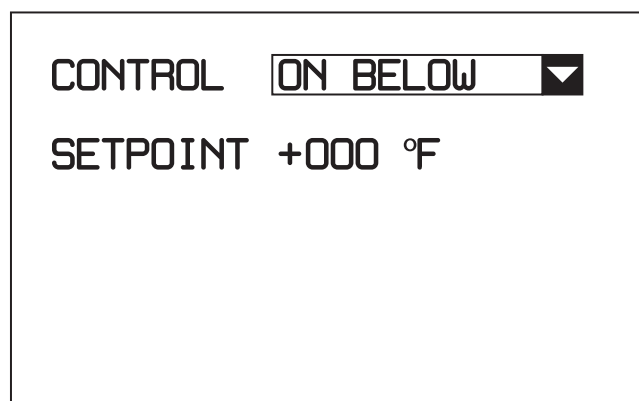

FIG. 34: ON BELOW

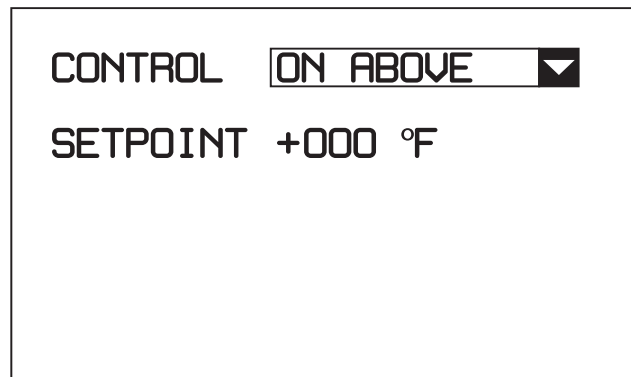

FIG. 35: ON ABOVE

Temp control allows the controller to read an external temperature probe to monitor the temperature and turn a pump on below or above a given temperature (See Fig. 16). ON BELOW is commonly used to turn a pump on below a certain temperature for cold weather applications.

DISPLAY only mode will not turn a pump on but will display the temperature on the controller. It'll also display and graph it in the historical charts on the web portal for CELL devices.

Graco offers a lug style temperature sensor (kit B32989) and a probe style temperature sensor (kit B32131). The user may also supply their own sensor but it must match the specs below to maintain accuracy.

- **Thermistor Type** = NTC
- **Resistance @ 25°C** = 10,000 Ω
- **R-T Curve** = J
- **Beta (0-50°C)** = 3892K
- **Resistance Tol.** -20°C to 20°C = $\pm 1^\circ\text{C}$
- **Temp. Coefficient @ 25°C** = -4.4 %/°C
- **Temperature Range** = -55°C to 105°C

Motor Over Current Alarm

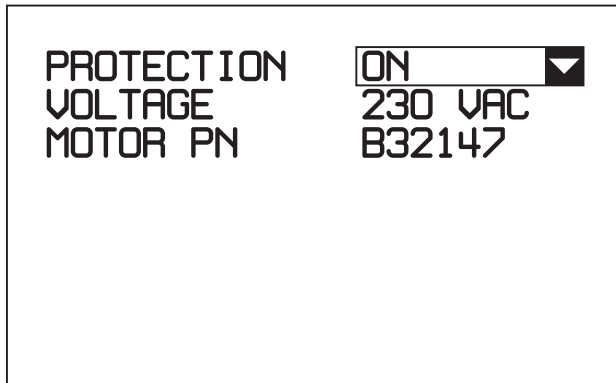

Fig. 36: PROTECTION ON Screen

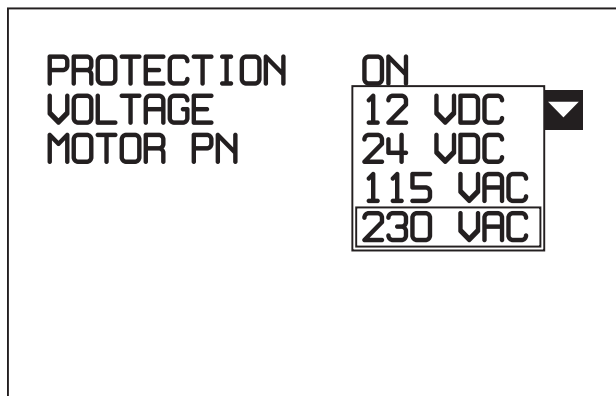

Fig. 37: VOLTAGE Screen

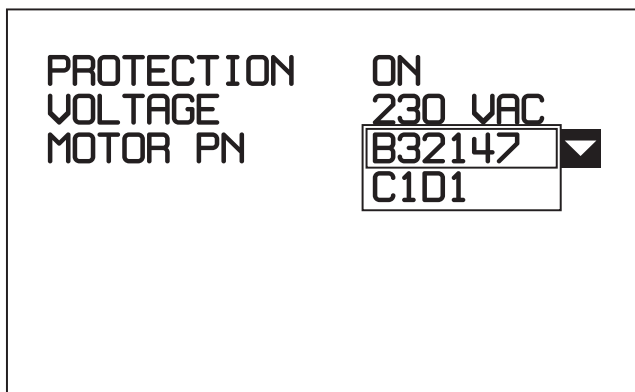

Fig. 38: MOTOR PN Screen

- **PROTECTION** - ON prompts for inputs on the system voltage and motor PN & will set the amperage limit according to the motor PN. OFF opens the amperage limit to the controller's rated max limit.
- **VOLTAGE** - The system and motor voltage.
- **MOTOR PN** - The specific motor PN or type of motor, for example: C1D1, used in the system.

When PROTECTION is ON, an alarm is activated when the amperage detected by the controller rises above the *motor's* rated amperage, for an extended period of time

When PROTECTION is OFF, an alarm is activated when the amperage detected by the controller rises above the *controller's* rated amperage, for an extended period of time.

The Harrier+ controller continuously monitors the amperage load of the motor. The controller will stop the pump and enter an alarm state if the amperage rises above the motor's or controller's rated max limit, depending on the settings selected.

Solenoid Alarms (Harrier+ MPI models only)

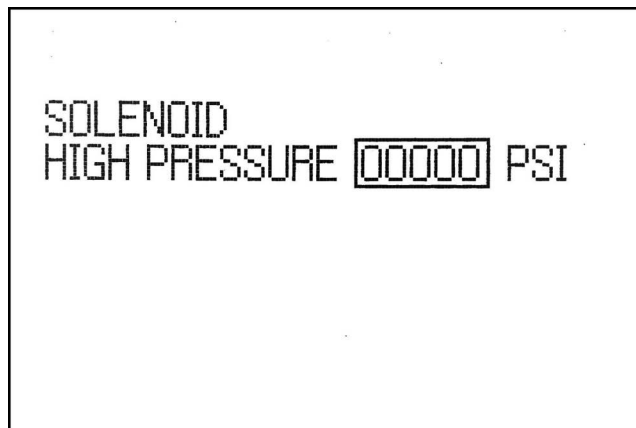

FIG. 39: Solenoid Alarms

NOTE: The Solenoid High Pressure alarm requires the B32072 Pressure Sensor Kit be installed between the pump and the solenoid valve manifold. Refer to the Pressure Sensor manual (see **Related Manuals** on page 3) for installation instructions.

This alarm is designed to detect a failed or plugged solenoid by monitoring the solenoid manifold pressure. The alarm is specific to a single solenoid valve.

Once an alarm is triggered for a solenoid valve, the system will continue to operate while skipping the failed solenoid during the injection sequence. A notification alarm will be displayed on the Run screen and communicated via the cellular or SCADA connection.

- **SOLENOID HIGH PRESSURE** - An alarm is activated when the pressure is higher than the specified value. The value should be set above the injection pressure and below the pump pressure relief valve (PRV) level to ensure proper operation.

PIN Code Setup Screen

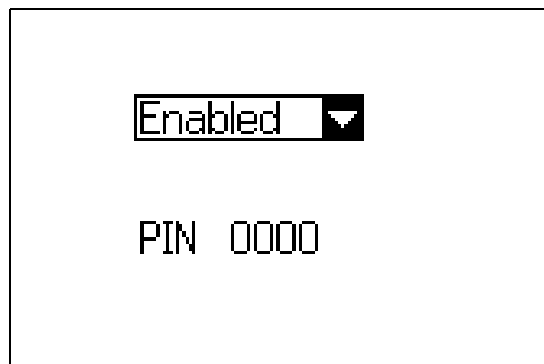

FIG. 40: PIN Code Setup screen

The PIN Code Setup screen allows you to enable a PIN Code (see FIG. 41) that prevents access to the Configuration screen (see FIG. 19) without the correct PIN Code.

1. On the **Configuration Screen**, page 31, highlight PIN CODE and press Enter to display the PIN Code setup screen.
2. Use the arrow keys to highlight the selection box, and press Enter.
3. Use the arrows to highlight either Enabled or Disabled, and press Enter.
4. If you selected Enabled, a pin box pops up. Use the arrow keys to highlight and select the desired value for the each digit in the PIN field. See FIG. 41.

NOTE: If you do not have the correct PIN code, you will not be able to regain access to the Configuration screen. Record your PIN Code before enabling PIN Code Entry. Contact Graco Customer Support if PIN is forgotten.

5. Verify the desired code is displayed in the PIN field, and press Enter.
6. Press Reset to return to the Configuration screen.

PIN Code Entry Screen

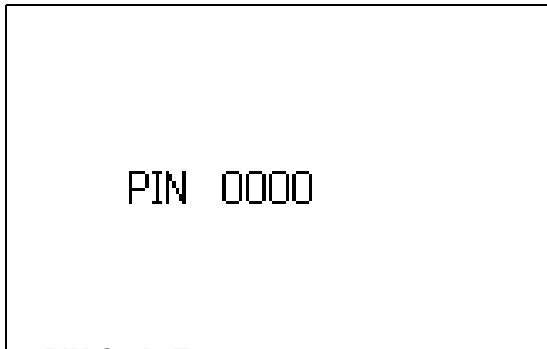

FIG. 41: PIN Code Entry screen

The PIN Code Entry screen appears before the Configuration screen only if PIN Code Entry was enabled on the PIN Code Setup screen (see 40).

1. Hold down the Enter key for 3 seconds to display the PIN Code Entry screen.
2. Use the arrows to highlight and select a value for each digit in the PIN code.
3. Verify the desired PIN code is displayed, and press Enter.
 - If the PIN code you entered is correct, the Configuration screen is displayed.
 - If the PIN code you entered is incorrect, the PIN Code Entry screen remains displayed. The Code must be re-entered by repeating step 2.

Network Setup Screen

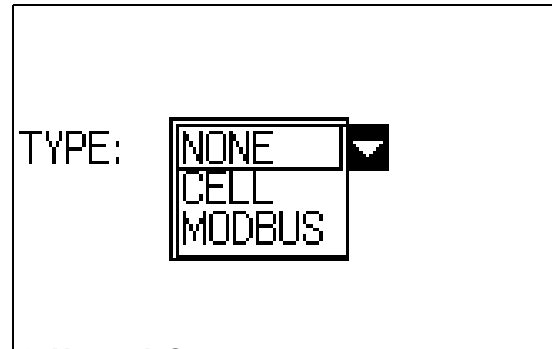

FIG. 42: Network Setup screen

The Network Setup screen is used to set the following:

- **CELL** - Allows controller to communicate to Harrier+ web portal. Only for controllers with cell modems. See **Models** on page 3.
 - **MODEBUS** - Enables Modbus communication between the controller and a Supervisory Control and Data Acquisition (SCADA) system to remotely monitor and control your pump. (See **Typical Installations**, starting on page 10.) Only for SCADA systems without a cell modem. See **Models** on page 3.
1. On the Configuration screen (see FIG. 19), select NETWORK from the list of setup screens, and press Enter to display the Network Setup screen (see FIG. 42).
 2. Use the arrows to highlight the TYPE field, and press Enter.
 3. Use the Up/Down arrows to highlight the desired network connection, and press Enter.
 4. Turn the Harrier+ controller Off and On after changing TYPE.

Cell Network Setup

1. From the Network Setup screen, select CELL in the TYPE field and press Enter to display the Activation Code screen.

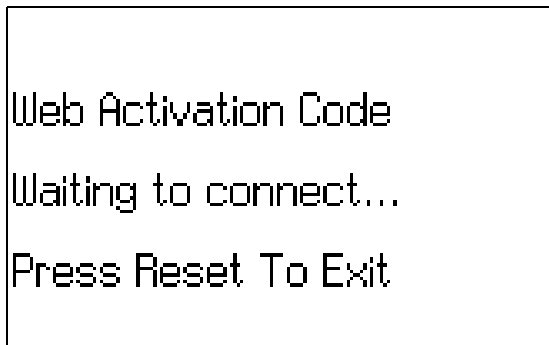

FIG. 43: Activation Code screen

If you press the Reset key while waiting to connect and return to the Network Setup screen, You will see the following screen.

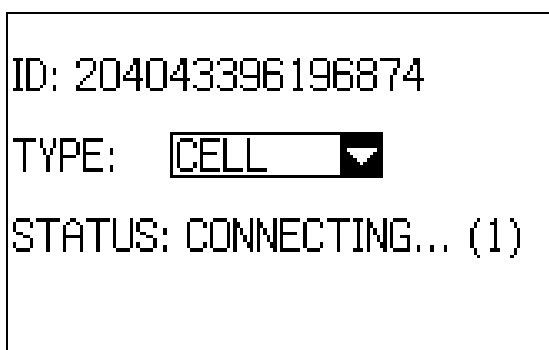

FIG. 44: Cell network connecting

Once connected, the network screen will display the pump name, pump ID, and signal strength.

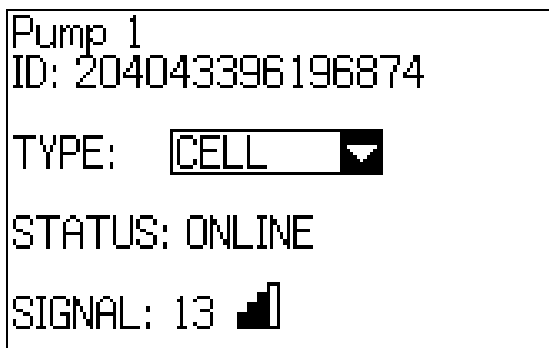

FIG. 45: Cell network connected

It is optimal to have more than one bar of signal strength. If you do not, you may move the equipment for better reception, or refer to **Troubleshooting** on page 72.

2. With CELL selected and STATUS: ONLINE, press the Enter key to display the Web Activation Code. This code is required for remote access to the pump when **Create a New Account** on page 56.

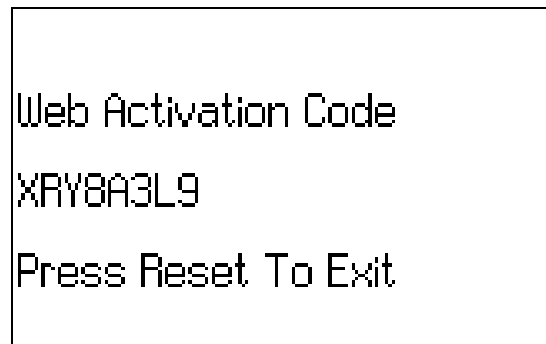

FIG. 46: Cell network Web Activation Code

3. Press Reset to return to the Network Setup screen.

Modbus Network Setup

With MODBUS selected, fields for a SLAVE ID, baud rate, parity, and stop bits will appear. See **Appendix A: Modbus Interface**, page 78, for details on interfacing with the controller. These settings must match the SCADA system or PC modbus master.

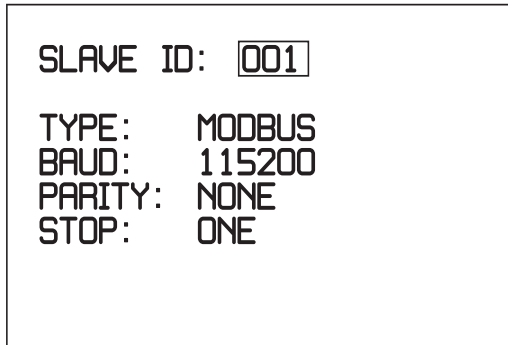

FIG. 47: Network Setup screen

- **SLAVE ID** - The slave ID identifies the Harrier+ controller within the SCADA system, Each controller in the SCADA system must have a unique slave ID between 1 and 247.
- **TYPE** - Select MODBUS for SCADA units. The controller uses MODBUS RTU/RS232 to communicate with a SCADA system. Converters or gateways can be connected to support other protocols.
- **BAUD** - Selectable baud rate serial port settings, options include 9,600 bits/sec, 19,200 bits/sec, 57,600 bits/sec, and 115,200 bits/sec.
- **PARITY** - Selectable serial port settings for parity, options include None, Odd, or Even.
- **STOP** - Selectable serial port settings for number of stop bits, options include One or Two.

1. Highlight the SLAVE ID field, and press Enter.
2. Use the arrow keys to highlight and select a value for each digit of the slave ID, and press Enter.
3. Use the arrow keys to navigate to each of the following fields: BAUD, PARITY, and STOP.
4. Press Enter to display each field option and use the arrow keys to highlight the option then press Enter to select.
5. Press Reset to return to the Configuration screen.

Advanced Setup Screen

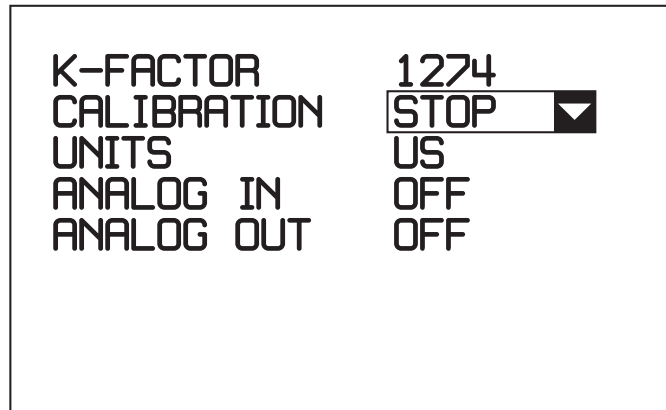

FIG. 48: Advanced Setup screen

The Advanced Setup screen is used to set the following:

- **K-FACTOR** - The current K-Factor. It cannot be edited on this screen, though it is automatically updated during calibration.
- **CAL VOLUME** - The volume pumped during calibration. Only appears during calibration.
- **CALIBRATION** - Calibrates the pump by automatically setting the K-Factor according to the volume dispensed. This will override any previous K-Factor entries on other setup screens. Calibration of the K-Factor is optional, though it does affect the accuracy of the actual flow rate and totalizers. Press start to initiate calibration.

Calibration can be stopped in one of two ways:

- Selecting STOP in this field.
 - Completing 5 cycles.
- **UNITS** - Specifies whether units are displayed as US or metric.
 - **ANALOG IN** - Allows an external 4-20 mA signal to vary the flow. (Flow Mode only) (See Analog In Screen).
 - **ANALOG OUT** - Enables the controller to output a 0-5V signal to control a variable speed motor (Flow Mode Only) (See Analog Out Screen).
1. On the Configuration screen, select ADVANCED from the list of setup screens, and press Enter to display the Advanced Setup screen.

Beaker Calibration Method

The beaker calibration method is described in steps 2-6.



This device automatically dispenses fluid once START is selected in the CALIBRATION field. To reduce the risk of serious injury, including skin injection, ensure that hands are clear of the outlet line and that a calibration beaker is in place before starting calibration.

- Only if pump calibration is needed using beaker method, direct an outlet line to the calibration beaker before starting calibration (Refer to the Wolverine pump manual (see **Related Manuals** on page 3) for the location of the outlet line and for the appropriate Pressure Relief Procedure).

- Highlight CALIBRATION, and press Enter.

- Highlight START and press Enter to immediately begin dispensing fluid into beaker.

NOTE: Calibration can be stopped in one of two ways:

- Selecting STOP in this field.
- Completing 5 cycles, as detected by the reed switch.

- Measure the fluid volume dispensed into the beaker and enter it in the CAL VOLUME field of the Advanced Setup Screen, which only appears after the calibration cycles are completed.

- The K-Factor field is automatically updated with the new K-FACOTR that reflects the volume dispensed.

- Highlight Analog In and press Enter on OFF or ON to pop up the Analog In setup screen (See Analog In).

- Highlight Analog Out and press Enter on FLOW to pop up the Analog Out setup screen (See Analog Out).

- Press Reset to return to the Configuration screen.

Analog In

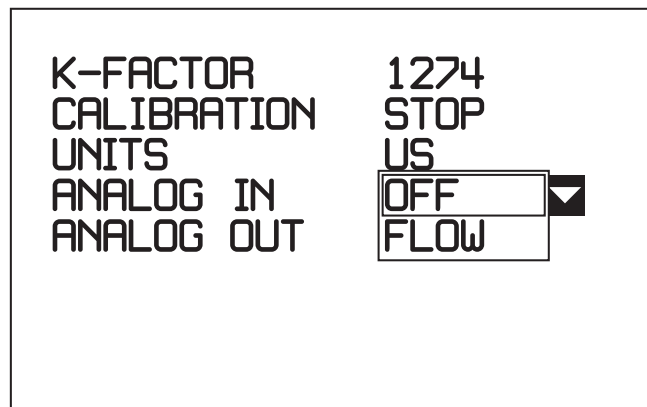

FIG. 49: ANALOG IN

Set ANALOG IN to FLOW to enable analog in and display the setup screen below.

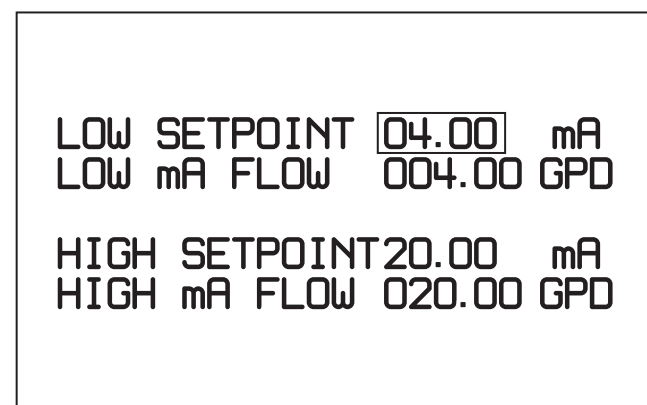

FIG. 50: ANALOG IN Setpoint Setup Screen

If analog in is enabled, a 4-20mA analog input signal can be used to automatically vary the flow rate (See FIG. 8 - FIG. 10). A common example is to use it to automatically adjust the flow rate based on a gas meter.

The flow rate is automatically calculated based on the 4-20mA input. It is scaled linearly between the high and low setpoints entered on this screen.

NOTE: Harrier+ MPI models (B328xx) only - When operating in multiple point injection (MPI) mode and using the Analog In feature, the same injection rate will be used for all Enabled injection points.

The Analog In Screen is used to set the following:

- **Low Setpoint** - The lowest mA value used on the 4-20mA range.
- **Low mA Flow** - The flow rate that corresponds to the low mA value. At "Low mA", the flow rate will be "Low mA Flow".
- **High Setpoint** - The highest mA value used on the 4-20mA range.
- **High mA Flow** - The flow rate that corresponds to the high mA value. At "High mA", the flow rate will be "High Flow Rate".

The flow rate cannot be adjusted manually when analog in is enabled, and therefore, is removed from the Pump Setup Screen and becomes read only on the web portal for CELL units.

Example 1: Full Range Setup

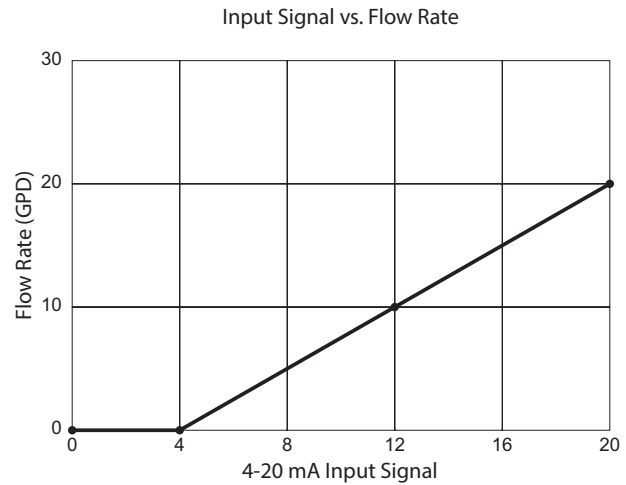

FIG. 51: Full Range Setup

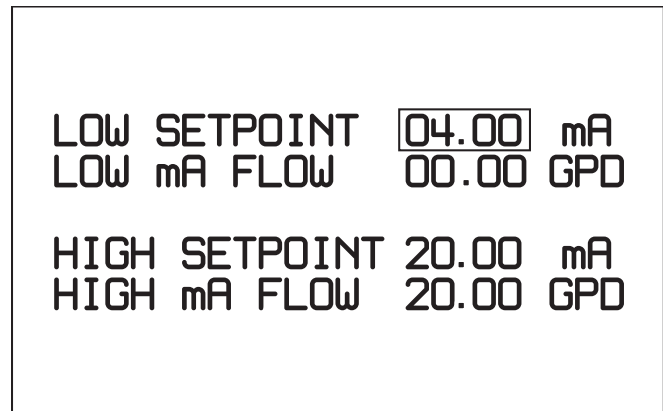

FIG. 52: Full Range Setup

1. Set inputs on Analog In Screen as shown.
2. Flow Rate is scaled linearly between 4 to 20mA and 0 to 20 GPD.
3. Signals less than 4mA are clamped to 0 GPD
 - 4 mA = 0 GPD
 - 12 mA = 10 GPD
 - 20 mA = 20 GPD

Example 2: Subset of Full Range Setup

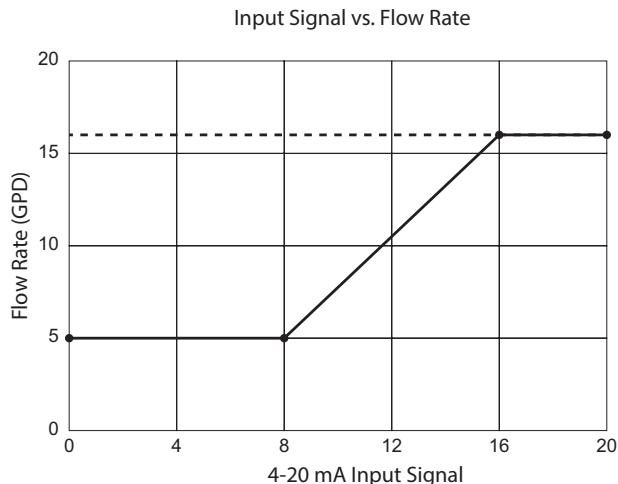

FIG. 53: Subset of Full Range Setup

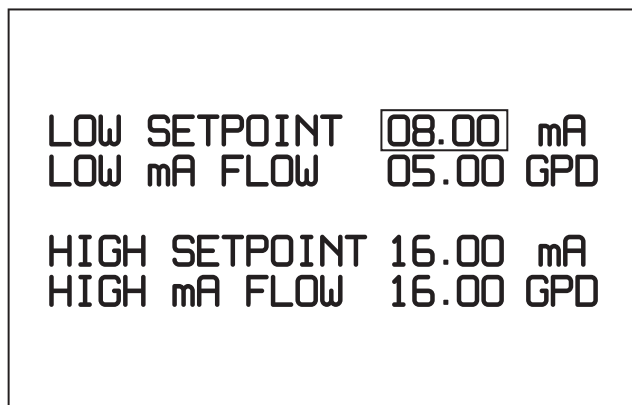

FIG. 54: Subset of Full Range Setup

1. Set inputs on Analog In Screen as shown.
2. Flow rate is scaled linearly between 8 to 16 mA and 5 to 16 GPD.
3. Signals less than 8 mA are clamped to the low flow rate, 5 GPD. Anything less than 8mA will set the flow rate to 5 GPD.
4. Signals greater than 16 mA are clamped to the high flow rate. Anything greater than 16mA will set the flow rate to 16 GPD.

The analog input can also be used in combination with the analog output to control a variable speed pump as the input signal changes. As the flow rate is automatically adjusted based on the input signal, the controller will automatically adjust the speed control voltage signal accordingly.

Analog Out

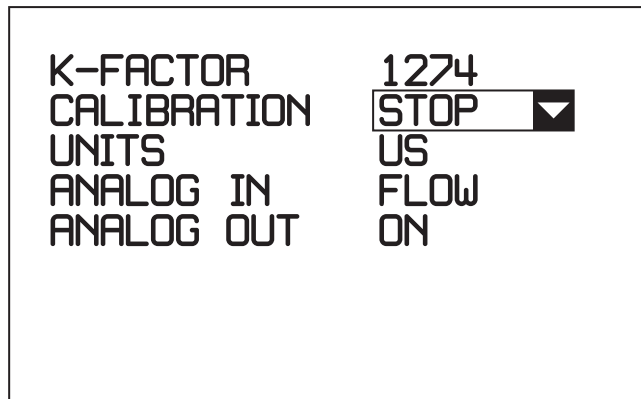

FIG. 55: Analog Out Screen

Set ANALOG OUT to ON to enable analog out and display the setup screen below.

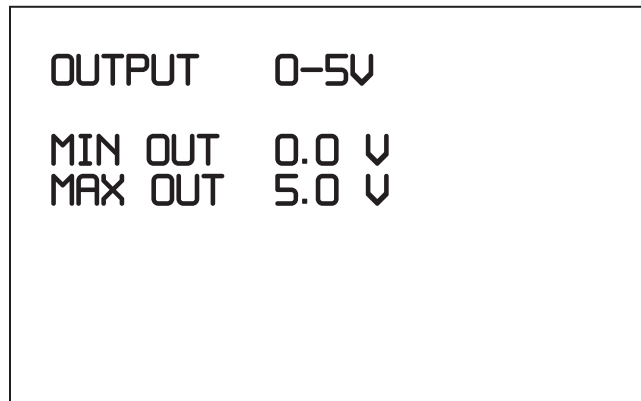

FIG. 56: Analog Output

If analog out is enabled, a 0-5V analog output signal can be used to control a variable speed motor (See Fig. 12). A theoretical maximum flow-rate is calculated using the k-factor. The 0-5V analog output signal supplied to the motor is then scaled linearly between zero and the calculated maximum flow rate.

The Analog Out Screen is used to set the following:

- MIN OUT - The lowest voltage the controller will output and therefore, corresponds to the minimum speed the pump will run at.
- MAX OUT - The highest voltage the controller will output and therefore, corresponds to the maximum speed the pump will run at.

The analog output is scaled in one of two ways:

1. The voltage output is a fixed value based on a percentage of the desired flow rate entered on the pump screen vs. the max flow rate of the pump.
2. The voltage output varies automatically based on the analog input. It's scaled based on a percentage of the analog flow rate calculated based on the analog input vs the max flow rate of the pump. It follows the analog input. As the input increases or decreases, so does the output.

For example:

MIN OUT = 0V

MAX OUT = 5V

Desired or Analog Flow Rate = 5 GPD

Max Flow Rate = 10 GPD

Analog Out = 2.5V

The max flow rate is a theoretical max based on the K-Factor.

The pump will stall at approximately 10 RPM = 0.8V on a 5V variable speed motor. This corresponds to is a minimum GPD that can be pumped before the pump stalls. To prevent stalling, care must be taken to make sure the desired flow rate or the analog input signal aren't so low that they are trying to drive an output voltage less than 0.8V.

The variable speed pump runs continuously and adjusts the speed up or down to hit a desired flow rate. Running at 5V will run the pump at max speed. Running less than 0.8V will stall the pump and 0V will stop the pump.

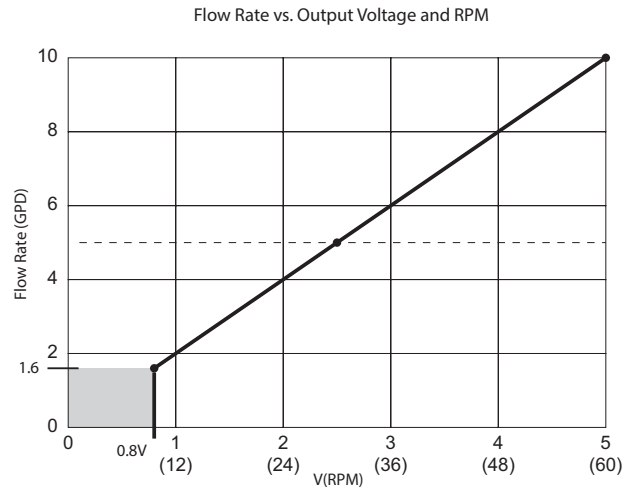

FIG. 57: Minimum Voltage at Which the Pump Stalls is 0.8V or 10 RPM

MIN OUT = 0V = 0 RPM

MAX OUT = 5V = 60 RPM Nominal

Stall Deadband = 0V-0.8V

In this example, See FIG. 57, the minimum flow rate the pump can do before stalling is 1.6 GPD. The max flow rate is 10 GPD at 5V. At 2.5 V the flow rate is 5 GPD.

Variable Speed Calibration

The pump must run at full speed while calibrating a variable speed pump. The controller will supply MAX OUT voltage to the motor while analog out is turned off to ensure full speed operation. Complete the steps below to set the pump to full speed & calibrate a variable speed pump.

1. Hit ENTER on the ANALOG OUT select box to bring up the analog out screen.
2. Set the Max Volts to 5V (Full Speed).
3. Exit back to the Advanced Screen by pushing the reset button.
4. Make sure ANALOG OUT says OFF.
5. Follow the calibration column or beaker method to calibrate your pump.
6. Set ANALOG OUT to ON once calibration is complete.
7. Set the desired flow-rate using FLOW mode to set a fixed output or enable ANALOG INPUT to have the output follow an input signal.

Fluid Pressure Setup Screen

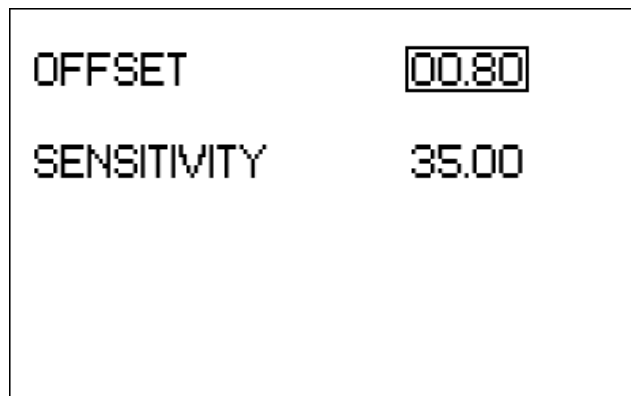

FIG. 58: Advanced Setup screen

The Fluid Pressure screen is used to set the following:

- **OFFSET**- The calibration offset value from the pressure transducer label. This is an optional feature that requires a pressure transducer. (See **Typical Installations** starting on page 10.)
 - **SENSITIVITY** - The calibration sensitivity value from the pressure transducer label. This is an optional feature that requires a pressure transducer. (See **Typical Installations** starting on page 10.)
1. If pressure transducer calibration is desired, highlight PRESS OFFSET and press Enter.
 2. Use the arrows to highlight and select a value for each digit of the pressure offset.
 3. Verify the desired value is displayed in the PRESS OFFSET field, and press Enter.
 4. If pressure transducer calibration is desired, highlight PRESS SENSITIVITY and press Enter.
 5. Use the arrows to highlight and select a value for each digit of the pressure sensitivity.
 6. Verify the desired value is displayed in the PRESS SENSITIVITY field, and press Enter.

Tank Level Setup Screen

This is an optional feature that requires a tank level monitor. See Tank Level Monitoring Kit manual (3A5375).

Run Screens

Screen Identification

The following screen is only shown as an example of the information that is displayed on a Run screen. Complete descriptions of the icons and symbols shown in FIG. 59 and FIG. 60 are provided on page 7.

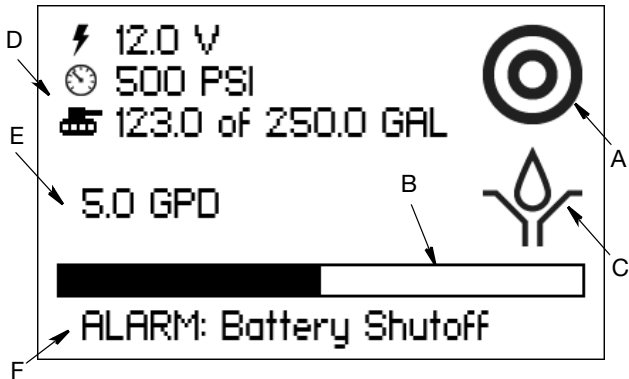

FIG. 59: Standard Models (B326xx) Run Screen

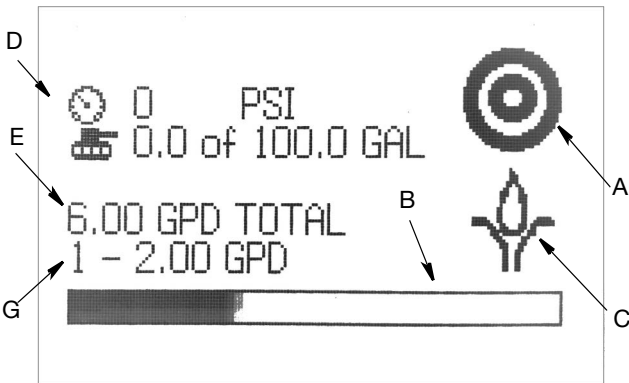

FIG. 60: MPI Models (B328xx) Run Screen

- A Operating Mode Identification** - Displays Flow Mode Active, Time Mode Active, or Cycle Mode Active icons depending on which metering mode is selected.
- B Progress Bar** - Real-time, visual representation of the elapsed time during a Pump On or Pump Off cycle.
- C Pump On/Off Indicator** - Visual indication of whether the pump is completing an On Cycle or Off Cycle.
- D DC Voltage, Pressure, Temperature and Tank Level** - Real-time voltage and pressure values. DC Voltage is not displayed when Power Save mode is Off. Pressure appears for both AC and DC models. Displays 0 PSI when no pressure transducer is connected. Real-time tank level and temperature.
- E Pump Run Summary** -
 - Flow Mode - Displays current desired Flow Rate
 - Time Mode - Displays current desired On and Off Times
 - Cycle Mode - Displays current desired On Cycle and Off Time
- F Status Line** - Area where status messages are displayed.
- G Solenoid (MPI models only)** - Displays the active solenoid and its corresponding flow rate.

Alarms and Signal Events

When an alarm or signal event occurs, the Run screen displays a status message indicating an alarm or event is active (see F on FIG. 59) and the Function LED (see FIG. 1) is lit. When an alarm or event is active, the pump goes into Standby mode.

To clear an alarm,

- Press the Reset key on the controller (see **Keypad, Display, and Icons**, page 6).
- Press the Reset icon on the Web application (see **Pumps Detail Screen (Pump Connected)**, page 61). Available on CDMA and GSM models. (See **Models**, page 3.)
- Send a Reset command through the SCADA interface using the Modbus map (see **Appendix A: Modbus Interface**, page 78). Available on SCADA models. (See **Models**, page 3.)





The following is a list of alarm events that may display.

Alarm Events

| Name | Type | Trigger Condition | Fixes and Actions |
|----------------------------------------------|--------------|--------------------------------------------------------------------------------------------------------------------------------------------------------------------------------------------------------------------------------------------|--------------------------------------------------------------------------------------------------------------------------------------------------------------------------------------------|
| Input 1 Ex. Tank Switch | Alarm | Switch activated according to the Normally Open / Normally Closed setting on the Alarms Setup Screen , page 38. Ex: Tank level is low | Check the device being monitored and reset the alarm. Ex: Refill the tank and press Reset on the controller. |
| Input 2 | Alarm | Switch activated according to the Normally Open / Normally Closed setting on the Alarms Setup Screen , page 38. | Check the device being monitored and reset the alarm. |
| Disabled by Remote Ex. Temperature Switch | Signal Event | The remote input sets the pump to Standby mode automatically according to the Normally Open / Normally Closed settings on the Alarms Setup Screen , page 38. Ex: Temperature is high | None required. The signal event automatically clears and sets the pump to Run mode without input from the user. Ex: Temperature falls enough to trip temperature switch and start pump. |
| High Pressure | Alarm | Pressure above the threshold set by user on the Alarms Setup Screen , page 38. | Check the system pressure and reset the alarm. |
| Low Pressure | Alarm | Pressure below the threshold set by user on the Alarms Setup Screen , page 38. | Check the system pressure and reset the alarm. |
| Counts Not Achieved | Alarm | Cycle switch signal not detected within the value specified in the Timeout fields of the Pump Setup Screen (Flow Mode) , page 31, and the Pump Setup Screen (Cycle Mode - Harrier+ Standard Models only [B326xx]) , page 37. | Check wiring. Replace the cycle switch and reset the alarm. |

| Name | Type | Trigger Condition | Fixes and Actions |
|------------------------|--------------|-----------------------------------------------------------------------------------------------------------------------------------------------------------------------------|------------------------------------------------------------------------------------------------------------------------------------------------------------------------------------------------------------------------------------------------------------------------------------------------------------------------------|
| Low Battery | Alarm | Battery voltage is below the value specified in the Battery Shutoff field of the Alarms Setup Screen , page 38. | Check solar panel connection. Replace battery. Alarm clears automatically when voltage is > threshold + 0.5V, or when the alarm is reset. |
| Analog In | Notification | The 4-20mA analog input is out of range, greater than 21mA or less than 3mA. | Measure the analog input & make sure it's within the 4-20mA range. Check wiring. Automatically clears when the signal rises above 4mA or below 20mA. |
| Temperature | Signal Event | Sets the pump to Standby mode automatically when the temperature rises above or below the set-points defined on the Alarms Setup Screen. | None required. The signal event automatically clears and sets the pump to Run mode without input from the user when the temperature changes. On Below: clears when temp is 2 degrees less than setpoint. On Above: clears when temp is 2 degrees more than setpoint. Check wiring if temperature is stuck at the max 118° F. |
| Over Current | Alarm | Motor amperage rises above the pump or controller rated maximum output capacity for an extended period of time. | Measure current draw of motor with current clamp & look for causes of overload condition like a closed ball valve. Reset the alarm. |
| Power Save Mode | Signal Event | Controller decreases the pump's on time by a MIN, NORMAL, & MAX percentage when the battery voltage drops below the POWER SAVE ON threshold (See the Alarms Setup Screens). | Check the battery voltage and charge batteries. Pump will run for less time to save battery voltage until condition is fixed or battery shutoff is reached. |
| Modbus Comms | Notification | Notifies user that modbus communication on SCADA units has been lost if the modbus comms alarm is enabled via SCADA. | Check the SCADA link to the controller, any converters, and wiring to re-establish communication. |
| Solenoid High Pressure | Notification | Notifies the user that the pressure has risen above the threshold set on the Alarms Setup Screen , page 38. | Check the solenoid that triggered the alarm. Replace the solenoid, if needed. |
| Relay Control Mode | Notification | Excessive current was drawn while the motor was off. An additional relay is activating. | Replace the controller at earliest convenience. |

Harrier+ Web Portal

| | | | | |
|-------------------------------------------------------------------------------------------------------------------------------------------------------------------------------------------------------------------------------------------------------------------------------------------------------------------------------------------------------------|-----------------------------------------------------------------------------------|-----------------------------------------------------------------------------------|-----------------------------------------------------------------------------------|--|
|  |  |  |  | |
| AUTOMATIC SYSTEM ACTIVATION HAZARD | | | | |
| <p>Unexpected activation of the system could result in serious injury, including skin injection and amputation.</p> | | | | |
| <p>This device has an automatic timer that activates the chemical injection system when power is connected or when exiting the programming function. The device can also be activated remotely from internet portals. Before you install or remove the controller from the system, disconnect and isolate all power supplies, and relieve all pressure.</p> | | | | |

The Harrier+ Web Portal allows you to remotely monitor and control your chemical injection pump from any computer or device with Internet access.

NOTE: Web Portal screens may be subject to continuing updates. See harrier.graco.com for updates and the most recent information.

Create a New Account

1. Go to <https://harrier.graco.com> to display the Graco login screen and select **Register new account** to display the Register New Account screen.



Register » New account

All fields are required.

| | |
|------------|-------------------------------------------|
| EMAIL | <input type="text" value="Email"/> |
| FIRST NAME | <input type="text" value="First name"/> |
| LAST NAME | <input type="text" value="Last name"/> |
| PASSWORD | <input type="text" value="New password"/> |

The pump activation key is displayed on the pump controller's network configuration screen. Choose "cell" from the drop-down menu on the controller to display the key.

| | |
|---------------------|--------------------------------------------------|
| PUMP ACTIVATION KEY | <input type="text" value="Pump activation key"/> |
|---------------------|--------------------------------------------------|

Choose a name for your group below. This will create a new group. Good choices could include your company or your division. If you want to join an existing group, have the group manager send you an invitation from the group's page.

| | |
|-------|------------------------------------|
| GROUP | <input type="text" value="Group"/> |
|-------|------------------------------------|

Register

FIG. 61: Register New Account screen

2. Fill in the fields on the Register New Account screen, following the on-screen instructions, and click **Register** to display the Account Pending screen. Call Graco Customer Support if you need assistance.



Account pending

Thank you for registering!

We've sent you an account activation message to the email address you provided. To finish activating your account, follow the link in that email.

If you don't receive an email from us within the next hour, please be sure to check your spam or junk folder.

Pump Control v1.0.281

FIG. 62: Account Pending screen

3. Check your email for an account activation message from Graco. Follow the instructions to activate your account and to display the Activation Complete screen.



Activation complete

Thank you for verifying your email address. Your account is now active.

You may log in now using your email address and the password you specified when setting up your account.

If did not set a password for your account, you can do so by using the [Forgot Password](#) link on the login page.

[Return to login page](#)

Pump Control v1.0.290

FIG. 63: Activation Complete screen

4. Click **Return to login page** to log in to the account.

Log In to the Web Portal

1. Go to <https://harrier.graco.com> to display the Graco login screen.



Email address

username@example.com

Password

Password

Stay logged in

Log in

[Register new account.](#)

[Forgot password?](#)

Pump Control v1.0.290

FIG. 64: Graco Login screen

2. Enter your username and password.

NOTE: Uncheck the **Stay logged in** box for maximum security to prevent unintended users from accessing your account.

3. Click **Log in** to display the Pumps List screen.

NOTE: The Terms of Service screen is displayed the first time you log in with a new account. The Pumps List screen is displayed once you've read and agreed to the Terms of Service.



[Pumps](#) [Groups](#) [Settings](#) [Help](#)

Terms of service

You must read and agree to the updated Terms of Service shown below to continue using this site.

End User License Agreement (EULA)

Graco Inc. agrees to provide you access to and use of its Software, under the terms and conditions specified below:

Configuration

You agree to use this Software with at least the minimum hardware and software requirements as set forth in the product documentation.

License Grant

Graco grants you a license to use the Software. "Use" means storing, loading, installing, executing or displaying the Software. You may not modify the Software or disable any licensing or control features of the Software. You agree to use the Software only in conjunction with Graco hardware.

I don't agree

I agree

Pump Control v1.0.281

FIG. 65: Terms of Service screen

Pumps List Screen

The Pumps List screen lists all of the available pumps in your group. The Pumps table features the following information:

- **Name** - This is the name of the pump within the group.
- **Group** - This is the name of pump's group, which is a user-defined collection or network of pumps and the users authorized to remotely view and control those pumps. It may be a company or a collection of users within a company. Group users are able to remotely view and control all pumps within the group. Refer to **Groups Detail Screen**, page 67.
- **Status** - This indicates whether the pump is running, on standby, offline, disabled by alarm, disabled by remote, or in power save mode.



[Pumps](#) [Groups](#) [Settings](#) [Help](#)

Pumps

| Name | Group | Status |
|------------------------|-------------------------------|---------|
| Pump 1 | Example Group | Standby |

Pump Control v1.0.290

FIG. 66: Pumps List screen

You can view the status of any pump in the network by clicking the name of the pump. This will display the Pump Detail screen, which differs depending on whether the pump is connected or disconnected.

- If the pump is connected, the Pump Detail screen will display a variety of information about the pump.
- If the pump is disconnected, you will see the Pump Detail screen shown in FIG. 69.

Pumps Detail Screen (Pump Connected)

The Pumps Detail screen displays the information available for a single connected pump. The information displayed below will vary depending on the pump metering mode. This screen is displayed when you click name of a connected pump on the Pumps List screen (FIG. 66).

The following information is available on this screen:

- **NAME** - This the name of the pump within the network. It can be edited by clicking the icon and entering a new name in the text box that appears.
- **STATUS** - This indicates the current network status of the pump. The icon can be used to toggle between Run and Standby. Putting the pump in Run mode will immediately start the pump. If the status indicates the pump has been disabled by an alarm, remote, or temperature, you will not be able to change the status until you reset the alarm in the ALARMS ACTIVE row.
- **ALARMS ACTIVE** - This indicates whether there are any active alarms for the pump. Any active alarms puts the pump into Standby mode, and the STATUS row will indicate that the pump is disabled by Alarm, Remote, or Temperature. You can reset active alarms by clicking the Reset icon in the Alarms Active row. The Reset icon only appears when an alarm is active.
- **METERING MODE** - This indicates whether the pump is running in Flow, Time, or Cycle mode. Some of the information on this screen is specific to a particular metering mode, and may not appear for all modes. The metering mode can only be changed from the Harrier+ controller on the Configuration screen. The information for each mode is listed below.

Flow Mode

- **FLOW RATE** - This is the desired number of gallons or liters to be pumped per day. Becomes read only when analog is in enabled and changes to ANALOG FLOW RATE.
- **TOTALIZER** - This is the number of gallons pumped since last time the Totalizer was reset. The Totalizer is reset by clicking the icon.
- **GRAND TOTALIZER** - This the total number of gallons pumped since the pump was added to the network. It cannot be reset.

Time Mode

- **ON TIME** - This is the desired amount of time the pump is to remain on.
- **OFF TIME** - This is the desired amount of time the pump is to remain off.

Cycle Mode

- **ON CYCLES** - This is the desired number of cycles the pump is to remain on.
- **ON TIMEOUT** - An alarm is triggered if a cycle is not detected within the time specified in the ON TIMEOUT field. This timer starts when the value in the OFF TIME field expires.
- **OFF TIME** - This is the desired amount of time the pump is to remain off after the desired number of cycles in the ON CYCLES field have completed.

- HISTORICAL CHARTS** - Clicking the icon displays the Historical Charts screen. For chart data, you may choose from Total pumped per day (the actual volume pumped, not the desired setting), Battery voltage, Fluid pressure, Monthly Report, Tank Level, or Temperature. For days to show, you may choose from the past 1, 7, 14, 30, or 90 days.

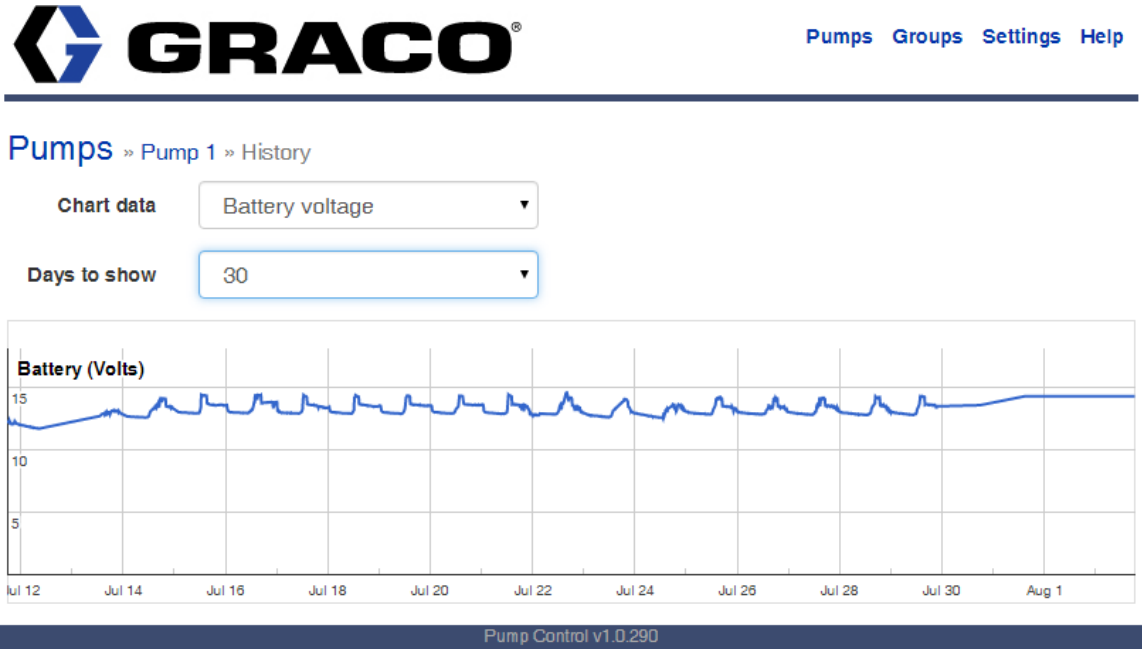

Fig. 67: History Chart of Battery Voltage for 30 days

- MAINTENANCE REMINDERS** - Clicking the icon displays the Maintenance Reminders screen, which allows you to add maintenance reminders; or lists any active reminders (such as Pump Service), their regularity, and when they are next due. Clicking Add Maintenance Reminder allows you to choose the type of reminder (Pump Service, Motor Service, Battery Service, and Chemical Tank Refill) and period (Immediate, or 1, 3, 6, 12, or 24 months). Reminders can also be customized by both subject and period (in months).

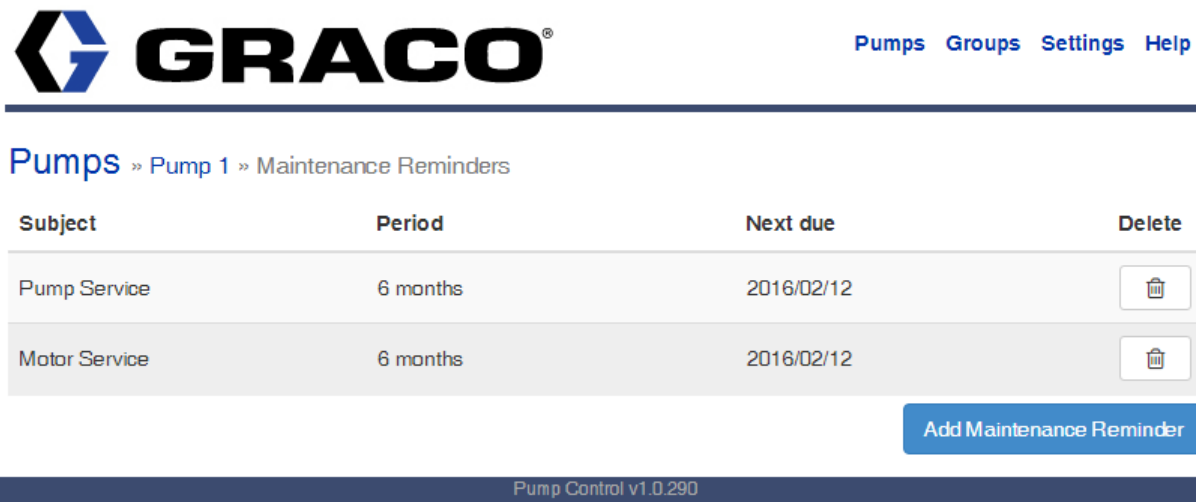

Fig. 68: Maintenance Reminders screen

Power Save Mode - These fields only appear when the Power Save mode is on. The following three fields (BATTERY VOLTAGE, POWER SAVE ON, and BATTERY SHUTOFF) will not appear when Power Save Mode is off.

- **BATTERY VOLTAGE** - Displays the current battery voltage if the optional battery monitor is connected.

- **POWER SAVE ON** - This is the battery voltage threshold at which Power Save mode is triggered. It can be edited by clicking the icon and entering a new voltage value in the text box that appears.

- **BATTERY SHUTOFF** - This is the battery voltage threshold for a low battery alarm to be triggered. It can be edited by clicking the icon and entering a new voltage value in the text box that appears.

- **PRESSURE LEVEL** - Displays the current pressure level if the optional pressure transducer is connected.
- **HIGH PRESSURE ALARM** - This is the pressure threshold for a high pressure alarm to be triggered. It can be edited by clicking the icon and entering a new pressure value in the text box that appears.
- **LOW PRESSURE ALARM** - This is the pressure threshold for a low pressure alarm to be triggered. It can be edited by clicking the icon and entering a new pressure value in the text box that appears.
- **TANK LEVEL** - Displays the current tank level.
- **LOW TANK NOTIFY** - Displays the low tank notify volume, the threshold for notify alarm to be triggered.
- **LOW TANK SHUTOFF** - Displays the low tank shutoff volume, the threshold for shutoff alarm to be triggered.
- **FLOW VERIFY PERCENTAGE** - Displays the maximum allowable correlation difference between the daily totalizer and daily tank level change. Only displayed if flow verify is enabled on controller.
- **TEMPERATURE** - The temperature is measured by the temp probe.
- **TEMP CONTROL** - Whether temp is disabled, display only, on above, or on below.
- **TEMP SETPOINT** - The temperature at which the pump turns on below or above this value. Only displayed if Temp control = on above or on below.
- **ALARM CUSTOMIZATION** - Allows the alarm #1, alarm #2, and auxiliary inputs to be custom named.
- **NETWORK** - This indicates whether the pump has network connectivity.
- **SIGNAL STRENGTH** - This is the network signal strength.
- **LOCATION** - This is a description of the pump's location. It can be edited by clicking the icon and entering a new location in the text box that appears.
- **MARKED LOCATION** - This is the longitude and latitude for the pump's location. This can be edited by the icon. You can either directly enter the longitude and latitude, or click the **Get Location** button to download your current coordinates. You can display a map view of your pump's location by clicking the coordinates. You must be next to the pump when you "Get Location".
- **GROUP** - This the name of group that was created or selected during account registration. Pumps are assigned to a group during account registration, or to an existing group at any time.

- **ACTIVATION KEY** - The Activation Key ties a pump (as identified by its Pump ID) to its assigned group. The Activation Key is generated at the pump by selecting “CELL” on the Network Setup screen. This field will only appear on this screen for group managers and administrators.
- **PUMP ID** - This is the Harrier+ controller’s unique pump ID.
- **DOWNLOAD HISTORY** - Clicking the icon downloads a CSV file with a log of all data sent to and from the pump; such as, firmware updates, changes to settings, and status updates.
- **FIRMWARE VERSION** - This is the version number of the firmware running on the Harrier+ controller.

Pumps Detail Screen (Pump Disconnected)

The Pumps Detail screen shown below is an example of the information available for a single disconnected pump. This screen is displayed when you click name of a disconnected pump on the Pumps List screen (FIG. 66).

The screenshot shows the GRACO web portal interface. At the top left is the GRACO logo. To the right are navigation links: Pumps, Settings, and Help. Below the logo is a breadcrumb trail: Pumps » Pump 1. The main content area is a table with the following rows:

| | | |
|-----------------------|-------------------------|--|
| NAME | Pump 1 | |
| HISTORICAL CHARTS | | |
| MAINTENANCE REMINDERS | | |
| NETWORK | Not connected | |
| LAST CONNECTED | 2015-06-02 17:04:40 CDT | |
| PUMP ID | 270113182612191782 | |

FIG. 69: Pumps Detail screen (pump disconnected)

The following information is available on this screen:

- **NAME** - This is the name of the pump within the network. It can be edited by clicking the icon and entering a new name in the text box that appears.
- **HISTORICAL CHARTS** - Clicking the icon displays the Historical Charts screen. For chart data, you may choose from Volume per Day, Battery, or Pressure. For days to show, you may choose from the past 1, 7, 14, 30, or 90 days.
- **MAINTENANCE REMINDERS** - Clicking the icon displays the Maintenance Reminders screen, which lists any active reminders, such as Pump Service, their regularity, and when they are next due. Clicking Add Maintenance Reminder allows you to choose the type of reminder (Pump Service, Motor Service, Battery Service, and Chemical Tank Refill) and period (Immediate, or 1, 3, 6, 12, or 24 months).
- **NETWORK** - This indicates whether the pump has network connectivity.
- **LAST CONNECTED** - This is the last date and time the Harrier+ controller had network connectivity.
- **PUMP ID** - This is the Harrier+ controller's unique pump ID.

Groups List Screen

The Groups List screen displays the groups you belong to. This screen is displayed when you click the Groups link at the top of any screen.



[Pumps](#) [Groups](#) [Settings](#) [Help](#)

Groups

| Name | Pump count | User count |
|-------------------------------|------------|------------|
| Example Group | 1 | 1 |

[Create group](#)

Pump Control v1.0.290

FIG. 70: Groups List screen

The following information is available on this screen:

- **Name** - This the name of all the groups you belong to. You can click any name to display a Groups Detail screen for the group (FIG. 71).
- **Pump count** - The number of pumps currently in a group.
- **User count** - The number of users currently in a group.

Groups Detail Screen

The Groups Detail screen displays information about a group, including the group’s manager, members, and pump. This screen is displayed by clicking the name of a group on the Groups List screen (FIG. 70).



FIG. 71: Group Detail screen

The following information is available on this screen:

- **NAME** - This the name of the group. It can be edited by clicking the icon and entering a new name in the text box that appears.
- **MANAGER** - This is email address of the group’s manager. They can edit exiting group fields, as well as add and delete users and pumps.
- **USERS** - Users can remotely view and control all pumps associated with the group. Click the icon to display a list of existing group users. Managers can use this screen to invite new users to the group and to remove existing users.



FIG. 72: Group User List screen

- **PUMPS** - Pumps associated with the group can be viewed and controlled by users in the group. Click the icon to display a list of all pumps associated with the group. Managers can use this screen to add and remove associated pumps.



[Pumps](#) [Groups](#) [Settings](#) [Help](#)

[Groups](#) » [Example Group](#) » [Pumps](#)

| Name | Status | Remove |
|--------|---------|----------------------------------|
| Pump 1 | Standby | <input type="button" value="⊘"/> |

Pump Control v1.0.290

FIG. 73: Groups Pumps screen

Invitation to Join a Group

If you want to join an existing group, the group manager can send you an invitation to join the group. You will receive an email from Graco inviting you to join the group. Click the link in the email to accept the invitation and display the Invitation screen shown in FIG. 74.



FIG. 74: Accept Invitation screen

Once you have accepted the invitation, you are able to remotely view and control all of the pumps in all of your groups. These pumps are added to your Pumps List screen.



FIG. 75: Pumps List screen after new group invitation

Settings Screen

The Settings screen allows you to view and edit your user settings. This screen is displayed when you click the Settings link at the top of any screen.



[Pumps](#) [Groups](#) [Settings](#) [Help](#)

Users » username@example.com

| | | |
|-------------------------|-------------------------------|--------------------------|
| EMAIL | username@example.com | |
| PASSWORD | | |
| FIRST NAME | John | |
| LAST NAME | Smith | |
| TIME ZONE | UTC | |
| DISPLAY UNITS | U.S. | |
| SHOW DISCONNECTED PUMPS | Yes | <input type="checkbox"/> |
| ENABLE REMINDERS | Yes | <input type="checkbox"/> |
| MAINTENANCE REMINDERS | | |
| GROUPS | Example Group | |

[Log out](#)

Pump Control v1.0.290

Fig. 76: Users screen

The following information is available on this screen:

- **EMAIL** - This is the email address associated with your username. You can edit this by clicking the icon and entering a new email address in the text box that appears.

- **PASSWORD** - This is your login password. You can edit this by clicking the icon and entering a new password in the text box that appears.
- **FIRST NAME** - Your first name.
- **LAST NAME** - Your last name.
- **TIME ZONE** - This is your time zone. You can edit this by clicking the icon and selecting another time zone from the drop-down menu that appears.
- **DISPLAY UNITS** - This indicates what units of measurement are used on screens and charts. You can edit this by clicking the icon and selecting either US or Metric from the drop-down menu that appears.
- **SHOW DISCONNECTED PUMPS** - This indicates whether the Pump List screen defaults to including disconnected pumps. You can toggle between Yes and No by clicking the icon.
- **ENABLE REMINDERS** - This indicates whether maintenance reminders are enabled. You can toggle between Yes and No by clicking the icon.
- **MAINTENANCE REMINDERS** - Clicking the icon displays the Maintenance Reminders screen, which lists any active reminders, such as Pump Service, their regularity, and when they are next due. Clicking Add Maintenance Reminder allows you to choose the type of reminder (Pump Service, Motor Service, Battery Service, and Chemical Tank Refill) and period (Immediate, or 1, 3, 6, 12, or 24 months).
- **GROUPS** - The groups you belong to.

Help Screen

The Help screen directs to you resources for additional information about technical support, related products, and patent information. This screen is displayed when you click the Help link at the top of any screen.

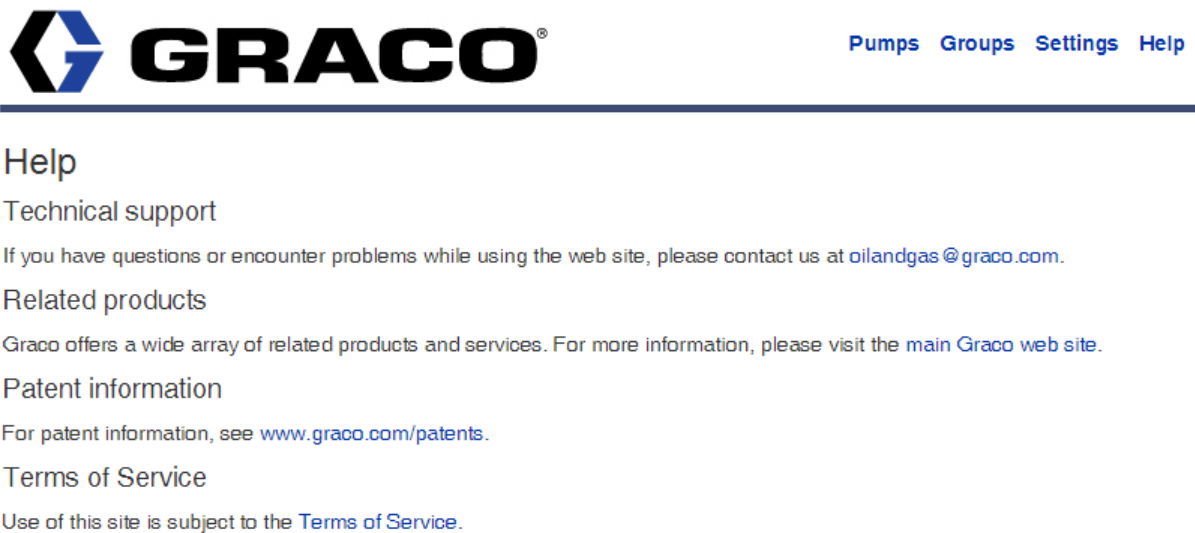

FIG. 77: Help screen

Troubleshooting



| Description | Problem | Solution |
|-------------------------------------------------------|------------------------------------|--------------------------------------------------------------------------------------------------------------------------------------------------------------------------------------|
| Unit does not power on or display is dim/unresponsive | Incorrect or loose wiring | Refer to Installation , page 9. |
| | Input voltage is out of range | Confirm power source is with the correct range. |
| | Tripped external fuse | Verify proper connections. Refer to Installation , page 9. |
| | Incorrect operating temperature | Verify ambient temperature is within recommended operating conditions. |
| Pressure transducer reading not working or inaccurate | Pressure transducer not calibrated | Refer to the Fluid Pressure Screen , page 47, for calibration information. |
| | Pressure transducer faulty | Replace pressure transducer |
| Pump not running | No power | Check wiring. Refer to Installation , page 9. |
| | There is an alarm | Check alarms. Refer to Alarms and Signal Events , page 53. |
| | Other | See Wolverine Chemical Injection Pump manual (334513). |
| Battery monitor not working | Not connected | Check wiring. Refer to Installation , page 9. |
| | Battery voltage too low | Check battery and wiring to the solar panel. |
| | Not enabled | Check setup screens. Refer to the Alarms Setup Screen , page 38. |
| Not connecting to a cell network | No signal | Check antenna orientation and mounting. Make sure antenna is pointing upwards towards sky. Make sure device is not located in a concrete building or near other interfering devices. |
| | | Verify antenna cables are connected. Use only the antenna provided. Refer to Antenna Connection , page 9. |
| | | Check cell service in the area. Consider high gain antenna kit. |
| | Incorrect network mode | Select CELL on the Network Setup Screen , page 44, and turn power to the controller Off and On. |
| | Modem not supported | Verify correct controller model for cell networks. Refer to Models , page 3. |

| Description | Problem | Solution |
|-----------------------------------|------------------------------------------------------|--------------------------------------------------------------------------------------------------------------------------------------------------------------------------------------|
| Not connecting to a SCADA network | Incorrect network mode | Select MODBUS on the Network Setup Screen , page 44, and turn power to the controller Off and On. |
| | Incorrect slave ID or Serial Port Settings | Verify the correct slave ID and serial port settings have been assigned to the controller on the Network Setup Screen , page 44, and turn power to the controller Off and On. |
| | Incorrect registers or values sent to the controller | Refer to Appendix A: Modbus Interface , page 78, for details on interfacing with the controller. |
| | Incorrect wiring | Check wiring. Refer to Installation , page 9, and verify the proper user-provided gateway adapter is connected correctly. |

Cellular Connection Status Codes

The Network Setup screen (see page 44) displays a status code while the modem is connecting to the cellular network with the current status code in parentheses (see FIG. 44 on page 45). These codes provide detail on which step the modem is currently on, but do not necessarily imply that an error is present. The modem will continue to retry the steps below until a connection to the cellular network is established. All steps will resolve themselves automatically with no user action; however, certain steps can be taken if the modem remains on the same step for an extended amount of time, as explained in the table below.

| Status Code No. | Description | Explanation / Solution |
|-----------------|-------------------------------------|-------------------------------------------------------------------------------------------------------------------------------------------------------------|
| 1 | Connection In Progress Status Code | Modem is trying to connect to the cellular network and will continue trying until a connection is established. No action is required. |
| 2 | AT Status Code | Modem is responding with an error or unexpected response. Cycle power. |
| 3 | Configuration Verbosity Status Code | Modem reported an error while enabling verbose error messages. Cycle power. |
| 4 | Signal Strength Status Code | Modem cannot detect a cell signal. Check cell service, antenna and antenna cables, try a high gain antenna, or cycle power. |
| 5 | Unique ID Status Code | Unable to retrieve the pump ID from the modem. Cycle power. |
| 6 | Registration Status Code | Modem is unable to register on the cellular network. Check cell service, antenna and antenna cables, try a high gain antenna, or cycle power. |
| 7 | Open Data Status Code | Modem is unable to open a data connection on the cellular network. Check cell service, antenna and antenna cables, try a high gain antenna, or cycle power. |
| 8 | Open Socket Status Code | Modem is unable to connect to the server. Check cell service, antenna and antenna cables, try a high gain antenna, or cycle power. |
| 9 | Location Status Code | Modem is unable to get the location. No action is required. Modem will automatically skip this error and retry. |
| 10 | SSL Status Code | Modem is unable to establish a secure connection and therefore, will not connect to the cellular network. Cycle power. |

Program Settings

| Description | Page | Modes of Operation, Maximums / Minimums, and Additional Comments |
|-----------------------------------------------------|---------------|----------------------------------------------------------------------------------------------------------------------------------------------------------------|
| Pump Modes | 34-37 | Flow, Time, Cycle (MPI Flow only) |
| Flow Rate (Flow Mode) | 34-36 | 0.1 - 600.0 GPD / 2,271.0 LPD. Restricted by K-Factor. Will automatically re-adjust value entered if K-Factor isn't large enough to support flow rate entered. |
| KFactor (Flow & Cycle Modes) | 37-35 | 1 - 9999 |
| Interval (Flow Mode) | 34 | 1 MIN, 5 MIN, 10 MIN, 12 HR, 24 HR |
| Cycle SW (Flow Mode) | 35 | Yes, No |
| On Time Off Time Timeout (Time or Cycle Mode) | 35 | HH:MM:SS (00:00:01 - 99:59:59) |
| On Cycles (Cycle Mode) | 37 | 01 - 99 |
| Alarm Type | 38-40 | Control, Battery, Pressure, Tank, Temp, Motor |
| Alarm Action | 38 | Stop, Notify |
| Input 1 (Alarm Screen: Control) | | Disabled, Normally Closed, Normally Open |
| Input 2 (Alarm Screen: Control) | | Disabled, Normally Closed, Normally Open |
| Remote Off/Auxiliary Switch (Alarm Screen: Control) | | Disabled, Normally Closed, Normally Open |
| Power Savings (Alarm Screen: Battery) | 39 | Off, Notify, Min, Normal, Max |
| Power Save On (Alarm Screen: Battery) | | 000.0 V - 999.9 V |
| Battery Shutoff (Alarm Screen: Battery) | | 000.0 V - 999.9 V |
| High Pressure Trigger (Alarm Screen: Pressure) | | 00000 - 99999 PSI |
| Low Pressure Trigger (Alarm Screen: Pressure) | | 00000 - 99999 PSI |
| Tank Alarms (Alarm Screen: Tank) | | See Tank Level Setup |
| Control (Alarm Screen: Temp) | | 40 |
| Setpoint (Alarm Screen: Temp) | -40°F - 118°F | |
| Protection (Alarm Screen: Motor) | 42 | On, Off |
| Voltage (Alarm Screen: Motor) | | 12 VDC, 24 VDC, 115 VAC, 230 VAC |
| Motor PN (Alarm Screen: Motor) | | List of motor PN's, varies depending on voltage selected |
| PIN Number Setup | | Enabled, Disabled |
| PIN Code Entry | | 0000 - 9999 |
| Network Type | | 43 |

| Description | Page | Modes of Operation, Maximums / Minimums, and Additional Comments |
|------------------------------------|------|----------------------------------------------------------------------------------------------|
| Slave ID (Network Type: Modbus) | 44 | 1-247 |
| Baud (Network Type: Modbus) | | 9,600 bits/sec, 19,200 bits/sec, 57,600 bits/sec, 115,200 bits/sec |
| Parity (Network Type: Modbus) | | None, Odd, Even |
| Stop (Network Type: Modbus) | | One, Two |
| Calibration (Network Type: Modbus) | | Stop, Start. Updates K-Factor. |
| Cal Volume | 44 | 000.0 to 999.99 CC |
| Units | 45 | US: Gallons per day / PSI / Inches |
| | | Metric: Liters per day / BAR / Centimeters |
| Analog In | | Off/Flow |
| Low Setpoint (Analog In: Flow) | | 4.00 mA – 20.00 mA |
| Low mA Flow (Analog In: Flow) | 46 | See Flow Rate |
| High Setpoint (Analog In: Flow) | | 4.00 mA – 20.00 mA |
| High mA Flow (Analog In: Flow) | | See Flow Rate |
| Analog Out | 47 | Off, On |
| Min Out (Analog Out: On) | | 0.0 – 5.9V |
| Max Out (Analog Out: On) | | 0.0 – 5.9V |
| Pressure transducer offset | 48 | 00.00 to 99.99. Located on pressure transducer label. Used to calibrate pressure transducer. |
| Pressure transducer sensitivity | | 00.00 to 99.99. Located on pressure transducer label. Used to calibrate pressure transducer. |
| Tank Level | | See Tank Level Setup |

Dimensions and Mounting Hole Layout

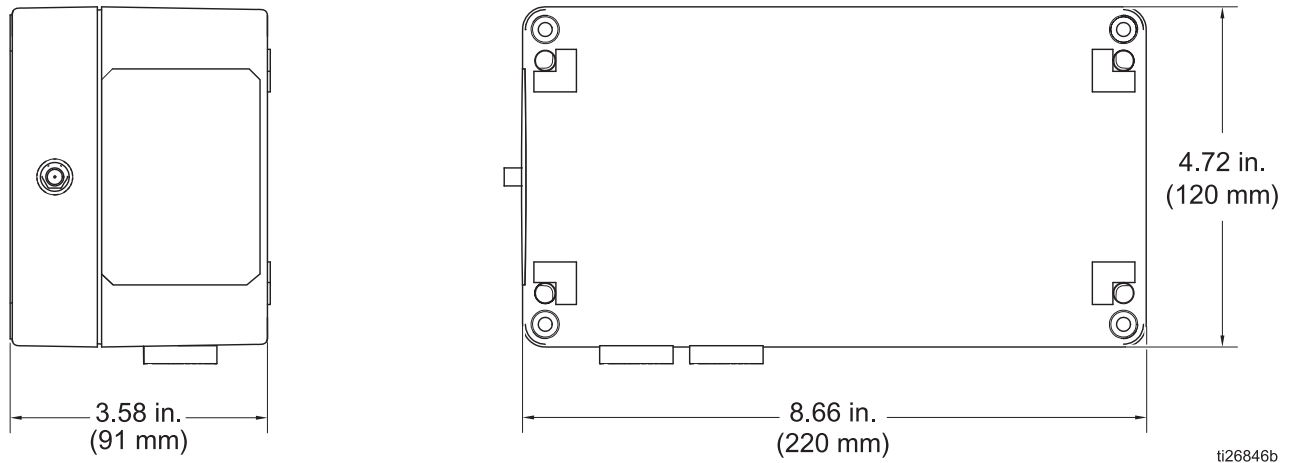

FIG. 78: Harrier+ Dimensions and Mounting Hole Layout

Kits and Accessories

| Part | Description |
|--------|----------------------------------------------------------------|
| B32788 | Standard Antenna Kit |
| B32699 | High-Gain Antenna Kit |
| B32072 | Line Pressure Sensor (6000 PSI) |
| B32771 | Tank Level Monitor Kit |
| B32088 | Calibration Column Kit (316 SST) |
| B32208 | Calibration Column Kit (303 SST) |
| B32089 | Tank Manifold with Calibration Column and Filter Kit (316 SST) |
| B33006 | Analog Out (Variable Speed DC Motors only) |
| 17G743 | Antenna Wire/ Bulkhead |
| B32874 | RS232 to RS485 Converter |
| B32989 | Lug Style Temperature Probe |
| B32131 | Barrel Style Temperature Probe |
| 24X261 | Token, Upgrade (Harrier+ Standard Models) |
| B33055 | Token, Upgrade (Harrier+ MPI Models) |

Appendix A: Modbus Interface

PC Interface

If desired, you can connect a PC to your controller by providing an adapter between the PC and the RS232 SCADA Interface cable (see K in FIG. 4 and FIG. 6). Your serial port must be configured to match the PC.

- Comm Port = COM1
- Baud Rate = 115200, 57600, 19200, 9600
- Data Bits = 8
- Parity = None, Odd, Even
- Stop Bits = 1, 2
- Flow Control = None

The serial port settings are configurable & must be set before any communication to the controller is started. See Fig. 46. Power must be cycled on the controller after changing the slave ID.

PLC Interface

Gateway adapters to the controller's RS232 SCADA interface (see K in FIG. 4 and FIG. 6) must be provided by user to support other protocols (see RS485 converter kit and wiring diagrams).

- Communication Mode: ModBus RTU/RS232
- Byte Order: Most Significant Byte (MSB) First
- 32-Bit Registers: Read 2 (16-bit) registers per parameter
- 16-Bit Registers: Read 1 (16-bit) register per parameter
- ModBus Register Offset: Protocol address = Modbus Register - 400001
- IE: Pump Status Modbus Register = 401004 and protocol address = 1003
- Comm Port Settings: Settings on the Harrier+ must match settings on the PLC
- See PC interface for configurable comm port settings.

The following tables list Modbus registers available to a PC or PLC. This map is subject to change depending on firmware revision. Contact customer service for the correct map for your specific firmware revision.

Variable Maps

The following tables list Modbus registers available to a PC or PLC.

Table 1: Harrier+ Modbus Read Parameters

| Modbus Register | Parameter Name | Data Type | Units | Range | Resolution | R/W Access | Notes |
|-----------------|-----------------------|-----------|--------------|-------------------------------------------------------------------------------------------------------------------------------------------------------------------------------------------------------------------------------------------------------------------------------------------------------------------------------------------------------------------------------------------------------------------------|---------------------|------------|-----------------------------------------------------------------|
| 401000 | Pressure PSI | uint32 | PSI or BAR | 0-14,000 | 1 PSI or .1 BAR | READ_ONLY | Val = Range x Resolution Pressure sensor equipped units only |
| 401002 | Battery Milli-volts | uint32 | mV | 0-50,000 | 1mV or 0.001V | READ_ONLY | Val = Range x Resolution |
| 401004 | Pump Status | uint32 | NA | 0-3 0: = Standby 1: = Run 2: = Lockout Alarm 3: = Lockout Remote | NA | READ_ONLY | |
| 401006 | Cycle Progress | uint32 | % | 0-100 | 1% | READ_ONLY | |
| 401008 | Total | uint32 | Gal or Liter | 0-0xFFFFFFFF | .01 Gal or .1 Liter | READ_ONLY | Val = Range x Resolution Applies to Flow Mode only |
| 401010 | Grand Total | uint32 | Gal or Liter | 0-0xFFFFFFFF | .01 Gal or .1 Liter | READ_ONLY | Val = Range x Resolution Applies to Flow Mode only |
| 401012 | Alarm Bit-field | uint32 | NA | 0-0xFFFFFFFF 0 = No alarm, 1 = Alarm active Bit 0: Relay Ctrl Mode Bit 1: Low Tank Shut-off Bit 2: Low Tank Notify Bit 3: Analog In Bit 4: Modbus Comms Bit 5: Flow Accuracy Bit 6: Count Not Achieved Bit 7: Input 1 Bit 8: Input 2 Bit 9: Temperature Bit 10: Battery Shutoff Bit 11: Not Used Bit 12: High Pressure Bit 13: Low Pressure Bit 14: Over Current | NA | READ_ONLY | |
| 401014 | Remote Disable Active | uint32 | NA | 0-0xFF 0: =FALSE 1: =TRUE | NA | READ_ONLY | Default Val = 0xFF until 1st change in aux input is detected |

| Modbus Register | Parameter Name | Data Type | Units | Range | Resolution | R/W Access | Notes |
|-----------------|-------------------|-----------|--------------|------------------------------------------------------------------------------------------------------------------------------|---------------------|------------|-----------------------------------------------------------------------------------------|
| 401016 | Tank Level | uint32 | Gal or Liter | 0-99,999 (Gal) | .1 Gal or .1 Liter | READ_ONLY | Val = Range x Resolution TLM equipped units only |
| 401018 | Analog Flow Rate | NA | Gal or Liter | 10-60,000 (Gal) | .01 Gal or .1 Liter | READ_ONLY | Val = Range x Resolution Use instead of desired flow rate when Analog In is enabled. |
| 401020 | Alarm Action | uint32 | NA | 0-1 0: = Stop 1: = Notify | NA | READ_ONLY | |
| 401022 | Metering Mode | uint32 | | 0-2 0: = Flow 1: = Time 2: = Cycles | NA | READ_ONLY | |
| 401024 | On Time | uint32 | Sec-onds | 1-359,999 (0x1-0x57E3F) | 1 sec | READ_ONLY | Max is 99 Hr, 59 min, 59 sec Time Mode Only |
| 401026 | Off Time | uint32 | Sec-onds | 0-359,999 (0x0-0x57E3F) | 1 sec | READ_ONLY | Max is 99 Hr, 59 min, 59 sec Time Mode Only |
| 401028 | On Cycles | uint32 | Cycles | 0-99 (0-0x63) | 1 cycle | READ_ONLY | Cycle Mode Only |
| 401030 | On Timeout | uint32 | Sec-onds | 1-359,999 (0x57E3F) | 1 sec | READ_ONLY | Max is 99 Hr, 59 min, 59 sec Flow and Cycle Mode |
| 401032 | Power Save Mode | uint32 | NA | 0-4 0: = Power Save Off 1: = Power Save Notify 2: = Power Save Min 3: = Power Save Normal 4: = Power Save Max | NA | READ_ONLY | |
| 401034 | Units | uint32 | NA | 0-1 0: = Imperial 1: = Metric | NA | READ_ONLY | |
| 401036 | Pressure Offset | uint32 | NA | 0-0x7FFFFFFF | NA | READ_ONLY | Pressure sensor equipped units only |
| 401038 | Pressure Slope | uint32 | NA | 0-0x7FFFFFFF | NA | READ_ONLY | Pressure sensor equipped units only |
| 401040 | K-Factor | uint32 | NA | 1-9,999 | 1 count | READ_ONLY | Flow Mode Only |
| 401042 | Desired Flow Rate | uint32 | Gal or Liter | 10-60,000 (Gal) | .01 Gal or .1 Liter | READ_ONLY | Use when Analog In is disabled Flow Mode Only |

| Modbus Register | Parameter Name | Data Type | Units | Range | Resolution | R/W Access | Notes |
|-----------------|----------------------------|-----------|--------------|---------------------------------------------------------------------------------------------|--------------------|------------|-----------------------------------------------------------------|
| 401044 | Software Version | uint32 | NA | 0-0xFFFFFFFF | NA | READ_ONLY | 0X00xyyzz, where xx = major yy = minor zz = build |
| 401046 | High Pressure Trigger | uint32 | PSI or BAR | 0-30,000 | 1 PSI or .1 BAR | READ_ONLY | Val = Range x Resolution Pressure sensor equipped units only |
| 401048 | Low Pressure Trigger | uint32 | PSI or BAR | 0-30,000 | 1 PSI or .1 BAR | READ_ONLY | Val = Range x Resolution Pressure sensor equipped units only |
| 401050 | Power Save Turn On | uint32 | mV | 0-99,999 | 1 mV or 0.001V | READ_ONLY | Val = Range x Resolution |
| 401052 | Battery Shutoff | uint32 | mV | 0-99,999 | 1 mV or 0.001V | READ_ONLY | Val = Range x Resolution |
| 401054 | Alarm 1 Trigger Type | uint32 | NA | 0-2 0: = Disabled 1: = Normally Closed 2: = Normally Opened | NA | READ_ONLY | |
| 401056 | Alarm 2 Trigger Type | uint32 | NA | 0-2 0: = Disabled 1: = Normally Closed 2: = Normally Opened | NA | READ_ONLY | |
| 401058 | Remote Off Trigger Type | uint32 | NA | 0-2 0: = Disabled 1: = Normally Closed 2: = Normally Opened | NA | READ_ONLY | |
| 401060 | Volume Mode Interval | uint32 | NA | 0-2 0: = 1 Minute 1: = 5 Minutes 2: = 10 Minutes 3: = 12 Hours 4: = 24 Hours | NA | READ_ONLY | Flow Mode Only |
| 401062 | Tank Level Notify Trigger | uint32 | Gal or Liter | 0-99,999 (Gal) | .1 Gal or .1 Liter | READ_ONLY | TLM equipped units only. |
| 401064 | Tank Level Shutoff Trigger | uint32 | Gal or Liter | 0-99,999 (Gal) | .1 Gal or .1 Liter | READ_ONLY | TLM equipped units only. |
| 401066 | Flow Verify Enable | uint32 | NA | 0-1 0: = Disabled 1: = Enabled | NA | READ_ONLY | SCADA program must write custom alarm if desired |
| 401068 | Flow Verify Percentage | uint32 | % | 0-999 | 1% | READ_ONLY | SCADA program must write custom alarm if desired |

Appendix A: Modbus Interface

| Modbus Register | Parameter Name | Data Type | Units | Range | Resolution | R/W Access | Notes |
|-----------------|-----------------------------------|-----------|--------------|------------------------------|---------------------|------------|-------------------------------------------------------------------------------|
| 401070 | Max Tank Volume | uint32 | Gal or Liter | 0-99,999 (Gal) | .1 Gal or .1 Liter | READ_ONLY | Val = Range x Resolution TLM equipped units only. |
| 401072 | Analog Flow Rate Low mA Setpoint | uint32 | Gal or Liter | 10-60,000 (Gal) | .01 Gal or .1 Liter | READ_ONLY | Val = Range x Resolution Analog In must be enabled |
| 401074 | Analog Flow Rate High mA Setpoint | uint32 | Gal or Liter | 10-60,000 (Gal) | .01 Gal or .1 Liter | READ_ONLY | Val = Range x Resolution Analog In must be enabled |
| 401076 | Analog In Control | uint32 | NA | 0-1 0: = Off 1: = Flow | NA | READ_ONLY | |
| 401078 | Analog Control Low mA Setpoint | uint32 | mA | 400-2,000 | .01mA | READ_ONLY | Val = Range x Resolution, for example: 4 to 20mA Analog In must be enabled |
| 401080 | Analog Control High mA Setpoint | uint32 | mA | 400-2,000 | .01mA | READ_ONLY | Val = Range x Resolution, for example: 4 to 20mA Analog In must be enabled |

Table 2: Harrier+ Modbus Write Parameters

| Modbus Register | Parameter Name | Data Type | Units | Range | Resolution | R/W Access | Notes |
|-----------------|-----------------|-----------|----------|-------------------------------------------------------------------------------------------------------------------------------------------------------------------|------------|------------|-------------------------------------------------------------------------|
| 401082 | Pump Status | uint32 | NA | 0-1 Writeable 0-5 Readable 0: = Standby 1: = Run 2: = Lockout Alarm 3: = Lockout Remote 4: = Lockout Power Save 5: = Lockout Temperature | NA | READ_WRITE | |
| 401084 | Alarm Action | uint32 | NA | 0-1 0: = Stop 1: = Notify | NA | READ_WRITE | |
| 401086 | Metering Mode | uint32 | NA | 0-2 0: = Flow 1: = Time 2: = Cycles | NA | READ_WRITE | Set & returns 0 if out of range Flow Mode only |
| 401088 | On Time | uint32 | Sec-onds | 1-359,999 (0x1-0x57E3F) | 1 sec | READ_WRITE | Time Mode Only |
| 401090 | Off Time | uint32 | Sec-onds | 0-359,999 (0x0-0x57E3F) | 1 sec | READ_WRITE | time Mode Only |
| 401092 | On Cycles | uint32 | Cycles | 0-99 (0-0x63) | 1 cycle | READ_WRITE | Cycle Mode Only |
| 401094 | On Timeout | uint32 | Sec-onds | 1-359,999 (0-0x57E3F) | 1 sec | READ_WRITE | Flow and Cycle Mode |
| 401096 | Power Save Mode | uint32 | NA | 0-4 0: = Power Save Off 1: = Power Save Notify 2: = Power Save Min 3: = Power Save Normal 4: = Power Save Max | NA | READ_WRITE | Set & returns 3 if out of range |
| 401098 | Units | uint32 | NA | 0-1 0: = Imperial 1: = Metric | NA | READ_WRITE | Set & returns 0 if out of range |
| 401100 | Pressure Offset | uint32 | mV/V | 0 - 0x7FFFFFFF | 0.01 mV/V | READ_WRITE | |
| 401102 | Pressure Slope | uint32 | mV/V | 0 - 0x7FFFFFFF | 0.01 mV/V | READ_WRITE | |
| 401104 | K-Factor | uint32 | NA | 1-9,999 | 1 count | READ_WRITE | Coerced to range if out of range, < 1 goes to 1 & > 9,999 goes to 9,999 |

| Modbus Register | Parameter Name | Data Type | Units | Range | Resolution | R/W Access | Notes |
|-----------------|----------------------------|-----------|--------------|-------------------------------------------------------------------------------------------------|---------------------|------------|------------------------------------------------------------------------------------------|
| 401106 | Desired Flow Rate | uint32 | Gal or Liter | 10-60,000 (Gal) | .01 Gal or .1 Liter | READ_WRITE | Clamps to min and max if out of range Flow Mode Only with Analog In disabled |
| 401108 | High Pressure Trigger | uint32 | PSI or Bar | 0-99,999 | 1 | READ_WRITE | Pressure sensor equipped units only |
| 401110 | Low Pressure Trigger | uint32 | PSI or Bar | 0-99,999 | 1 | READ_WRITE | Pressure sensor equipped units only |
| 401112 | Power Save Turn On | uint32 | mV | 0-99,999 | 1 mV or 0.001V | READ_WRITE | |
| 401114 | Battery Shut-off | uint32 | mV | 0-99,999 | 1 mV or 0.001V | READ_WRITE | |
| 401116 | Alarm 1 Trigger Type | uint32 | NA | 0-2 0: = Disabled 1: = Normally Closed 2: = Normally Opened | NA | READ_WRITE | Set & returns 0 if out of range |
| 401118 | Alarm 2 Trigger Type | uint32 | NA | 0-2 0: = Disabled 1: = Normally Closed 2: = Normally Opened | NA | READ_WRITE | Set & returns 0 if out of range |
| 401120 | Remote Off Trigger Type | uint32 | NA | 0-2 0: = Disabled 1: = Normally Closed 2: = Normally Opened | NA | READ_WRITE | |
| 401122 | Volume Mode Interval | uint32 | NA | 0-2 0: = 1 Minute 1: = 5 Minutes 2: = 10 Minutes 3: = 12 Hours 4: = 24 Hours | NA | READ_WRITE | Set & returns 0 if out of range. Flow Mode Only. |
| 401124 | Tank Level Notify Trigger | uint32 | Gal or Liter | 0-9,999 | .1 Gal or .1 Liter | READ_WRITE | TLM equipped units only |
| 401126 | Tank Level Shutoff Trigger | uint32 | Gal or Liter | 0-9,999 | .1 Gal or .1 Liter | READ_WRITE | TLM equipped units only |
| 401128 | Flow Verify Enable | uint32 | NA | 0-1 0: = Disabled 1: = Enabled | NA | READ_WRITE | Sets & returns 0 if out of range SCADA program must write custom alarm if desired |
| 401130 | Flow Verify Percentage | uint32 | % | 0-200 | 1% | READ_WRITE | SCADA program must write custom alarm if desired |

| Modbus Register | Parameter Name | Data Type | Units | Range | Resolution | R/W Access | Notes |
|-----------------|-----------------------------------|-----------|--------------|------------------------------|---------------------|------------|-------------------------------------------------------------------------------------------------------------------------------------------|
| 401132 | Analog Flow Rate Low mA Setpoint | uint32 | Gal or Liter | 10-60,000(Gal) | .01 Gal or .1 Liter | READ_WRITE | Analog In must be enabled |
| 401134 | Analog Flow Rate High mA Setpoint | uint32 | Gal or Liter | 10-60,000(Gal) | .01 Gal or .1 Liter | READ_WRITE | Analog In must be enabled |
| 401136 | Analog In Control | uint32 | NA | 0-1 0: = Off 1: = Flow | NA | READ_WRITE | |
| 401138 | Analog Control Low mA Setpoint | uint32 | mA | 400-2,000 | .01 mA | READ_WRITE | Must be less than High mA set-point, invalid inputs will be clamped between 4mA and the High mA Setpoint-1 Analog In must be enabled |
| 401140 | Analog Control High mA Setpoint | uint32 | mA | 400-2,000 | .01 mA | READ_WRITE | Must be greater than Low mA setpoint+1, invalid inputs will be clamped between the Low mA Setpoint and 20 mA Analog In must be enabled |

Table 3: Reset Parameters

| Modbus Register | Parameter Name | Data Type | Units | Range | Resolution | R/W Access | Notes |
|-----------------|-----------------|-----------|-------|--------------------------------|------------|------------|-----------------------------------------------------------------------------------------------------------|
| 401142 | Totalizer Reset | uint32 | NA | 0-1 0: = FALSE 1: = TRUE | NA | WRITE ONLY | Reset Totalizer Must write 1 to reset the totalizer Must toggle, only writes on change |
| 401144 | Clear Alarms | uint32 | NA | 0-1 0: = FALSE 1: = TRUE | NA | WRITE ONLY | Reset Clear Alarm Statu Must write 1 to reset the alarms Must toggle, only writes on change |

Table 4: 16 Bit Registers

| Modbus Register | Parameter Name | Data Type | Units | Range | Resolution | R/W Access | Notes |
|-----------------|--------------------------------|-----------|--------------|-----------------------------------------------------------------------------------------------------------------------------------------------------------------------------------------------------------------------------------------------------------------------------------------------------------------------------------------------------------------------------------------------------------------------|-----------------------|------------|-------------------------------------------------------------------------------------------------|
| 401146 | Battery Milli-volts Upper Word | uint16 | mV | Unused | NA | READ ONLY | |
| 401147 | Battery Milli-volts Lower Word | uint16 | mV | 0-50000 | 1mV or 0.001V | READ ONLY | Val = Range x Resolution |
| 401148 | Alarm Bitfield Upper Word | uint16 | NA | Unused | NA | READ ONLY | |
| 401149 | Alarm Bitfield Lower Word | uint16 | NA | 0-0xFFFFFFFF 0 = Relay Ctrl Mode 1 = Alarm active Bit 0: Unused Bit 1: Low Tank Shut-off Bit 2: Low Tank Notify Bit 3: Analog In Bit 4: Modbus Comms Bit 5: Flow Accuracy Bit 6: Count Not Achieved Bit 7: Input 1 Bit 8: Input 2 Bit 9: Temperature Bit 10: Battery Shut-off Bit 11: Not Used Bit 12: High Pressure Bit 13: Low Pressure Bit 14: Over Current | NA | READ ONLY | |
| 401150 | Tank Height Upper Word | uint16 | Inches or cm | Unused | NA | READ ONLY | |
| 401151 | Tank Height Lower Word | uint16 | Inches or cm | 0-14,400 (Inches) | 0.01 Inches or 0.1 cm | READ ONLY | Val = Range x Resolution Val = Height in Inches (not gallons) TLM equipped units only |
| 401152 | K-factor Upper Word | uint16 | NA | Unused | 1 count | READ ONLY | |
| 401153 | K-factor Lower Word | uint16 | NA | 1-99,99 | 1 count | READ ONLY | Flow Mode Only |

| Modbus Register | Parameter Name | Data Type | Units | Range | Resolution | R/W Access | Notes |
|-----------------|------------------------|-----------|--------------|------------------------------------------------------------------------------------------------------------------------------------------------------------------|----------------------|------------|--------------------------------------------------------------------------------------------------|
| 401154 | Pump Status Upper Word | uint16 | NA | Unused | NA | READ ONLY | |
| 401155 | Pump Status Lower Word | uint16 | NA | 0-1 Writable 0-5 Readable 0: = Standby 1: = Run 2: = Lockout Alarm 3: = Lockout Remote 4: = Lockout Power Save 5: = Lockout Temperature | NA | READ ONLY | |
| 401156 | Grand Total 16-Bit | uint16 | Gal or Liter | 0-32,767 (Gal) | .01 Gal or .1 Liter | READ_WRITE | Val = Range x Resolution Val rolls back to 0 at 32,767 Flow Mode only |
| 401157 | Desired Flow Rate | uint16 | Gal or Liter | 10-60,000 (Gal) | .01 Gal or 0.1 Liter | READ_WRITE | Val = Range x Resolution Flow Mode only with Analog In disabled |
| 401158 | Pump Status Inhibit | uint16 | NA | 0-1 Writeable 0: = Run 1: = Standby | NA | READ_WRITE | Opposite of Pump Status |
| 401159 | Clear Alarm Status | uint16 | NA | 0-1 0: = FALSE 1: = TRUE | NA | WRITE ONLY | |
| 401160 | Update Heartbeat Tick | uint16 | NA | 0-0xFFFF | NA | READ_WRITE | Write any value to this register to increment heartbeat counter if modbus comms alarm is enabled |
| 401161 | Modbus Comms Enable | uint16 | NA | 0-1 0: = Disabled 1: = Enabled | NA | READ_WRITE | |

| Modbus Register | Parameter Name | Data Type | Units | Range | Resolution | R/W Access | Notes |
|-----------------|-----------------------------|-----------|--------------|-------------------|-----------------------|------------|--------------------------------------------------------------------------------------------------------------------------------------|
| 401162 | Tank Height Notify Trigger | uint16 | Inches or cm | 0-14,400 (Inches) | 0.01 Inches or 0.1 cm | READ_WRITE | Coerced to range if out of range, > 14400, set to 14400 & < 0, set to 0 Val = Height in Inches TLM equipped units only |
| 401163 | Tank Height Shutoff Trigger | uint16 | Inches or cm | 0-14,400 (Inches) | 0.01 Inches or 0.1 cm | READ_WRITE | Coerced to range if out of range, > 14400, set to 14400 & < 0, set to 0 Val = Height in Inches TLM equipped units only |

Table 5: Analog Output Registers

| Modbus Register | Parameter Name | Data Type | Units | Range | Resolution | R/W Access | Notes |
|-----------------|--------------------|-----------|-------|-------------------------------|------------|------------|-----------------------------------------------------------------|
| 401164 | Analog Out Control | uint32 | NA | 0-1 0: = OFF 1: = ON | NA | READ_ONLY | |
| 401166 | Aout Min Out | uint32 | Volts | 0-59 | 0.1 Volts | READ_ONLY | Val = Range x Resolution Only when Analog Out is enabled |
| 401168 | Aout Max Out | uint32 | Volts | 0-59 | 0.1 Volts | READ_ONLY | |
| 401170 | Aout Type | uint32 | NA | 0-14 0: = Volts 1: = MA | NA | READ_ONLY | |
| 401172 | Analog Out Control | uint32 | NA | 0-1 0: = OFF 1: = ON | NA | READ_WRITE | |
| 401174 | Aout Min Out | uint32 | Volts | 0-59 | 0.1 Volts | READ_WRITE | Val = Range x Resolution Only when Analog Out is enabled |
| 401176 | Aout Max Out | uint32 | Volts | 0-59 | 0.1 Volts | READ_WRITE | Val = Range x Resolution Only when Analog Out is enabled |

Table 6: Temperature Registers

| Modbus Register | Parameter Name | Data Type | Units | Range | Resolution | R/W Access | Notes |
|-----------------|----------------|-----------|----------|------------------------------------------------------------------------|------------|------------|-----------------------------------------------------------------------------------------------------------|
| 401178 | Temperature | uint32 | °F or °C | -40 to 118 (°F) | 1 ° | READ_ONLY | |
| 401180 | Temp Control | uint32 | NA | 0-3 0: = DISABLED 1: = DISPLAY 2: = ON BELOW 3: = ON ABOVE | NA | READ_ONLY | |
| 401182 | Temp Setpoint | uint32 | °F or °C | -40 to 118 (°F) | 1 ° | READ_ONLY | Temp Control must be set to On Above or On Below to use the setpoint |
| 401184 | Temp Control | uint32 | NA | 0-3 0: = DISABLED 1: = DISPLAY 2: = ON BELOW 3: = ON ABOVE | NA | READ_WRITE | |
| 401186 | Temp Setpoint | uint32 | °F or °C | -40 to 118 (°F) | 1 ° | READ_WRITE | Only writes if >= -40 & <= 118 deg F Temp Control must be set to On Above or On Below to use the setpoint |

Table 7: Multi-Point Injection Registers (Harrier+ MPI controllers only)

| Modbus Register | Parameter Name | Data Type | Units | Range | Resolution | R/W Access | Notes |
|-----------------|--------------------|-----------|--------------|-----------------------------------------------------|---------------------|------------|--------------------------|
| 1188 | Multi-point Enable | uint32 | NA | 0-2 0: = DISABLED 1: = VARIABLE 2: = FIXED | NA | READ_ONLY | |
| 1190 | Well 1 Flow Rate | uint32 | Gal or Liter | 1-60,000 (Gal) | .01 Gal or .1 Liter | READ_ONLY | Val = Range x Resolution |
| 1192 | Well 2 Flow Rate | uint32 | Gal or Liter | 1-60,000 (Gal) | .01 Gal or .1 Liter | READ_ONLY | Val = Range x Resolution |
| 1194 | Well 3 Flow Rate | uint32 | Gal or Liter | 1-60,000 (Gal) | .01 Gal or .1 Liter | READ_ONLY | Val = Range x Resolution |
| 1196 | Well 4 Flow Rate | uint32 | Gal or Liter | 1-60,000 (Gal) | .01 Gal or .1 Liter | READ_ONLY | Val = Range x Resolution |
| 1198 | Well 5 Flow Rate | uint32 | Gal or Liter | 1-60,000 (Gal) | .01 Gal or .1 Liter | READ_ONLY | Val = Range x Resolution |
| 1200 | Well 6 Flow Rate | uint32 | Gal or Liter | 1-60,000 (Gal) | .01 Gal or .1 Liter | READ_ONLY | Val = Range x Resolution |
| 1202 | Well 7 Flow Rate | uint32 | Gal or Liter | 1-60,000 (Gal) | .01 Gal or .1 Liter | READ_ONLY | Val = Range x Resolution |
| 1204 | Well 8 Flow Rate | uint32 | Gal or Liter | 1-60,000 (Gal) | .01 Gal or .1 Liter | READ_ONLY | Val = Range x Resolution |

| Modbus Register | Parameter Name | Data Type | Units | Range | Resolution | R/W Access | Notes |
|-----------------|---------------------------|-----------|--------------|-------------------------------------------------------------------------------------------------------------------------------------------------------------------------------------------------------------------------------------------|---------------------|------------|--------------------------|
| 1206 | Well Enable Bitfield | uint32 | NA | 0-0xFF 0 = Disabled 1 = Enabled Bit 0: Well 1 Enable Bit 1: Well 2 Enable Bit 2: Well 3 Enable Bit 3: Well 4 Enable Bit 4: Well 5 Enable Bit 5: Well 6 Enable Bit 6: Well 7 Enable Bit 7: Well 8 Enable | 1 bit | READ_ONLY | |
| 1208 | Well 1 Total | uint32 | Gal or Liter | 0-0xFFFFFFFF | .01 Gal or .1 Liter | READ_ONLY | Val = Range x Resolution |
| 1210 | Well 2 Total | uint32 | Gal or Liter | 0-0xFFFFFFFF | .01 Gal or .1 Liter | READ_ONLY | Val = Range x Resolution |
| 1212 | Well 3 Total | uint32 | Gal or Liter | 0-0xFFFFFFFF | .01 Gal or .1 Liter | READ_ONLY | Val = Range x Resolution |
| 1214 | Well 4 Total | uint32 | Gal or Liter | 0-0xFFFFFFFF | .01 Gal or .1 Liter | READ_ONLY | Val = Range x Resolution |
| 1216 | Well 5 Total | uint32 | Gal or Liter | 0-0xFFFFFFFF | .01 Gal or .1 Liter | READ_ONLY | Val = Range x Resolution |
| 1218 | Well 6 Total | uint32 | Gal or Liter | 0-0xFFFFFFFF | .01 Gal or .1 Liter | READ_ONLY | Val = Range x Resolution |
| 1220 | Well 7 Total | uint32 | Gal or Liter | 0-0xFFFFFFFF | .01 Gal or .1 Liter | READ_ONLY | Val = Range x Resolution |
| 1222 | Well 8 Total | uint32 | Gal or Liter | 0-0xFFFFFFFF | .01 Gal or .1 Liter | READ_ONLY | Val = Range x Resolution |
| 1224 | Grand Total Well 1 | uint32 | Gal or Liter | 0-0xFFFFFFFF | .01 Gal or .1 Liter | READ_ONLY | Val = Range x Resolution |
| 1226 | Grand Total Well 2 | uint32 | Gal or Liter | 0-0xFFFFFFFF | .01 Gal or .1 Liter | READ_ONLY | Val = Range x Resolution |
| 1228 | Grand Total Well 3 | uint32 | Gal or Liter | 0-0xFFFFFFFF | .01 Gal or .1 Liter | READ_ONLY | Val = Range x Resolution |
| 1230 | Grand Total Well 4 | uint32 | Gal or Liter | 0-0xFFFFFFFF | .01 Gal or .1 Liter | READ_ONLY | Val = Range x Resolution |
| 1232 | Grand Total Well 5 | uint32 | Gal or Liter | 0-0xFFFFFFFF | .01 Gal or .1 Liter | READ_ONLY | Val = Range x Resolution |
| 1234 | Grand Total Well 6 | uint32 | Gal or Liter | 0-0xFFFFFFFF | .01 Gal or .1 Liter | READ_ONLY | Val = Range x Resolution |
| 1236 | Grand Total Well 7 | uint32 | Gal or Liter | 0-0xFFFFFFFF | .01 Gal or .1 Liter | READ_ONLY | Val = Range x Resolution |
| 1238 | Grand Total Well 8 | uint32 | Gal or Liter | 0-0xFFFFFFFF | .01 Gal or .1 Liter | READ_ONLY | Val = Range x Resolution |
| 1240 | Solenoid Pressure Trigger | uint32 | PSI or Bar | 0-30,000 | 1 psi | READ_ONLY | |
| 1242 | Active Solenoid | uint32 | NA | 0-7 | 1 psi | READ_ONLY | |

| Modbus Register | Parameter Name | Data Type | Units | Range | Resolution | R/W Access | Notes |
|-----------------|---------------------------|-----------|--------------|-------------------------------------------------------------------------------------------------------------------------------------------------------------------------------------------------------------------------------------------------|---------------------|------------|------------------------------------------------------------------------------------------------------|
| 1244 | Well 1 Flow Rate | uint32 | Gal or Liter | 1-60,000 (Gal) | .01 Gal or .1 Liter | READ_WRITE | Val = Range x Resolution |
| 1246 | Well 2 Flow Rate | uint32 | Gal or Liter | 1-60,000 (Gal) | .01 Gal or .1 Liter | READ_WRITE | Val = Range x Resolution |
| 1248 | Well 3 Flow Rate | uint32 | Gal or Liter | 1-60,000 (Gal) | .01 Gal or .1 Liter | READ_WRITE | Val = Range x Resolution |
| 1250 | Well 4 Flow Rate | uint32 | Gal or Liter | 1-60,000 (Gal) | .01 Gal or .1 Liter | READ_WRITE | Val = Range x Resolution |
| 1252 | Well 5 Flow Rate | uint32 | Gal or Liter | 1-60,000 (Gal) | .01 Gal or .1 Liter | READ_WRITE | Val = Range x Resolution |
| 1254 | Well 6 Flow Rate | uint32 | Gal or Liter | 1-60,000 (Gal) | .01 Gal or .1 Liter | READ_WRITE | Val = Range x Resolution |
| 1256 | Well 7 Flow Rate | uint32 | Gal or Liter | 1-60,000 (Gal) | .01 Gal or .1 Liter | READ_WRITE | Val = Range x Resolution |
| 1258 | Well 8 Flow Rate | uint32 | Gal or Liter | 1-60,000 (Gal) | .01 Gal or .1 Liter | READ_WRITE | Val = Range x Resolution |
| 1260 | Well Enable Bitfield | uint32 | | 0-0xFF 0 = Disabled, 1 = Enabled) Bit 0: Well 1 Enable Bit 1: Well 2 Enable Bit 2: Well 3 Enable Bit 3: Well 4 Enable Bit 4: Well 5 Enable Bit 5: Well 6 Enable Bit 6: Well 7 Enable Bit 7: Well 8 Enable | | READ_WRITE | |
| 1262 | Solenoid Pressure Trigger | uint32 | PSI or Bar | 0-30,000 | 1 psi | READ_WRITE | |
| 1264 | Well 1 Totalizer Reset | UINT32 | NA | 0-1 0: = FALSE 1: = TRUE | NA | READ_WRITE | Reset Totalizer Must write 1 to reset the totalizer Must toggle, only writes on change |
| 1266 | Well 2 Totalizer Reset | UINT32 | NA | 0-1 0: = FALSE 1: = TRUE | NA | READ_WRITE | Reset Totalizer Must write 1 to reset the totalizer Must toggle, only writes on change |
| 1268 | Well 3 Totalizer Reset | UINT32 | NA | 0-1 0: = FALSE 1: = TRUE | NA | READ_WRITE | Reset Totalizer Must write 1 to reset the totalizer Must toggle, only writes on change |

| Modbus Register | Parameter Name | Data Type | Units | Range | Resolution | R/W Access | Notes |
|-----------------|------------------------|-----------|-------|--------------------------------|------------|------------|------------------------------------------------------------------------------------------------------|
| 1270 | Well 4 Totalizer Reset | UINT32 | NA | 0-1 0: = FALSE 1: = TRUE | NA | READ_WRITE | Reset Totalizer Must write 1 to reset the totalizer Must toggle, only writes on change |
| 1272 | Well 5 Totalizer Reset | UINT32 | NA | 0-1 0: = FALSE 1: = TRUE | NA | READ_WRITE | Reset Totalizer Must write 1 to reset the totalizer Must toggle, only writes on change |
| 1274 | Well 6 Totalizer Reset | UINT32 | NA | 0-1 0: = FALSE 1: = TRUE | NA | READ_WRITE | Reset Totalizer Must write 1 to reset the totalizer Must toggle, only writes on change |
| 1276 | Well 7 Totalizer Reset | UINT32 | NA | 0-1 0: = FALSE 1: = TRUE | NA | READ_WRITE | Reset Totalizer Must write 1 to reset the totalizer Must toggle, only writes on change |
| 1278 | Well 8 Totalizer Reset | UINT32 | NA | 0-1 0: = FALSE 1: = TRUE | NA | READ_WRITE | Reset Totalizer Must write 1 to reset the totalizer Must toggle, only writes on change |

Technical Data

| Harrier+ MPI Chemical Injection Controller | |
|---------------------------------------------------------------|--------------------------------------------------------------------------|
| Input Contact | |
| Power Source (DC) | 9 - 26 VDC |
| Power Source (AC) | 100 VAC to 240 VAC - 50/60 Hz |
| Power consumption, max load (DC) | 416 Watts |
| Power consumption, max load (120 VAC) | 600 Watts |
| Power consumption, max load (240 VAC) | 720 Watts |
| Cycle Control Pressure Input | Normally open cycle switch |
| Remote Disable (Auxiliary) Input | Configurable active high/low for normally open or normally closed switch |
| Outputs | |
| Pump control | Pump Control Voltage = Power Source |
| Voltage | Power Source |
| Max Switching Voltage (DC) | 26 VDC |
| Max Switching Voltage (AC) | 240 VAC |
| Max Switching Current (DC) | 25 A |
| Max Switching Current (AC) | |
| | 120 VAC 5 A |
| | 240 VAC 3 A |
| Minimum Switching Capacity | 100 mA @ 5 VDC |
| Enclosure Material | Polycarbonate + PET |
| Membrane Material | Polyester |
| Environmental | |
| Protection Grade (Controller must be housed inside enclosure) | Type 1 |
| Operating Temperature Range | - 40°F to 131°F (- 40°C to 55°C) |
| Storage Temperature | - 13°F to 131°F (- 25°C to 55°C) |
| Duty Cycle | |
| AC Models | 100% |
| DC Models | 90% (60 seconds typical) |

California Proposition 65

CALIFORNIA RESIDENTS

 **WARNING:** Cancer and reproductive harm – www.P65warnings.ca.gov.

Graco Standard Warranty

Graco warrants all equipment referenced in this document which is manufactured by Graco and bearing its name to be free from defects in material and workmanship on the date of sale to the original purchaser for use. With the exception of any special, extended, or limited warranty published by Graco, Graco will, for a period of twelve months from the date of sale, repair or replace any part of the equipment determined by Graco to be defective. This warranty applies only when the equipment is installed, operated and maintained in accordance with Graco's written recommendations.

This warranty does not cover, and Graco shall not be liable for general wear and tear, or any malfunction, damage or wear caused by faulty installation, misapplication, abrasion, corrosion, inadequate or improper maintenance, negligence, accident, tampering, or substitution of non-Graco component parts. Nor shall Graco be liable for malfunction, damage or wear caused by the incompatibility of Graco equipment with structures, accessories, equipment or materials not supplied by Graco, or the improper design, manufacture, installation, operation or maintenance of structures, accessories, equipment or materials not supplied by Graco.

This warranty is conditioned upon the prepaid return of the equipment claimed to be defective to an authorized Graco distributor for verification of the claimed defect. If the claimed defect is verified, Graco will repair or replace free of charge any defective parts. The equipment will be returned to the original purchaser transportation prepaid. If inspection of the equipment does not disclose any defect in material or workmanship, repairs will be made at a reasonable charge, which charges may include the costs of parts, labor, and transportation.

THIS WARRANTY IS EXCLUSIVE, AND IS IN LIEU OF ANY OTHER WARRANTIES, EXPRESS OR IMPLIED, INCLUDING BUT NOT LIMITED TO WARRANTY OF MERCHANTABILITY OR WARRANTY OF FITNESS FOR A PARTICULAR PURPOSE.

Graco's sole obligation and buyer's sole remedy for any breach of warranty shall be as set forth above. The buyer agrees that no other remedy (including, but not limited to, incidental or consequential damages for lost profits, lost sales, injury to person or property, or any other incidental or consequential loss) shall be available. Any action for breach of warranty must be brought within two (2) years of the date of sale.

GRACO MAKES NO WARRANTY, AND DISCLAIMS ALL IMPLIED WARRANTIES OF MERCHANTABILITY AND FITNESS FOR A PARTICULAR PURPOSE, IN CONNECTION WITH ACCESSORIES, EQUIPMENT, MATERIALS OR COMPONENTS SOLD BUT NOT MANUFACTURED BY GRACO. These items sold, but not manufactured by Graco (such as electric motors, switches, hose, etc.), are subject to the warranty, if any, of their manufacturer. Graco will provide purchaser with reasonable assistance in making any claim for breach of these warranties.

In no event will Graco be liable for indirect, incidental, special or consequential damages resulting from Graco supplying equipment hereunder, or the furnishing, performance, or use of any products or other goods sold hereto, whether due to a breach of contract, breach of warranty, the negligence of Graco, or otherwise.

FOR GRACO CANADA CUSTOMERS

The Parties acknowledge that they have required that the present document, as well as all documents, notices and legal proceedings entered into, given or instituted pursuant hereto or relating directly or indirectly hereto, be drawn up in English. Les parties reconnaissent avoir convenu que la rédaction du présente document sera en Anglais, ainsi que tous documents, avis et procédures judiciaires exécutés, donnés ou intentés, à la suite de ou en rapport, directement ou indirectement, avec les procédures concernées.

Graco Information

For the latest information about Graco products, visit www.graco.com.

For patent information, see www.graco.com/patents.

TO PLACE AN ORDER, contact your Graco distributor or call to identify the nearest distributor.

Phone: 612-623-6928 or **Toll Free:** 1-800-533-9655, **Fax:** 612-378-3590

All written and visual data contained in this document reflects the latest product information available at the time of publication. Graco reserves the right to make changes at any time without notice.

Original instructions. This manual contains English. MM 3A4130

Graco Headquarters: Minneapolis

International Offices: Belgium, China, Japan, Korea

GRACO INC. AND SUBSIDIARIES • P.O. BOX 1441 • MINNEAPOLIS MN 55440-1441 • USA
Copyright 2015, Graco Inc. All Graco manufacturing locations are registered to ISO 9001.

www.graco.com

Revision L, April 2024