



E-Flo® DC 2000, 3000, and 4000 Circulation Pumps

3A3453H
EN

Electric drive piston pumps for high volume paint circulation applications.
For professional use only.



Important Safety Instructions

Read all warnings and instructions in this manual, and in the E-Flo DC Motor and E-Flo DC Three Phase manuals. Save these instructions.

*See Technical Data, page 75, for
Maximum Working Pressure.
See page 3 for model information.*

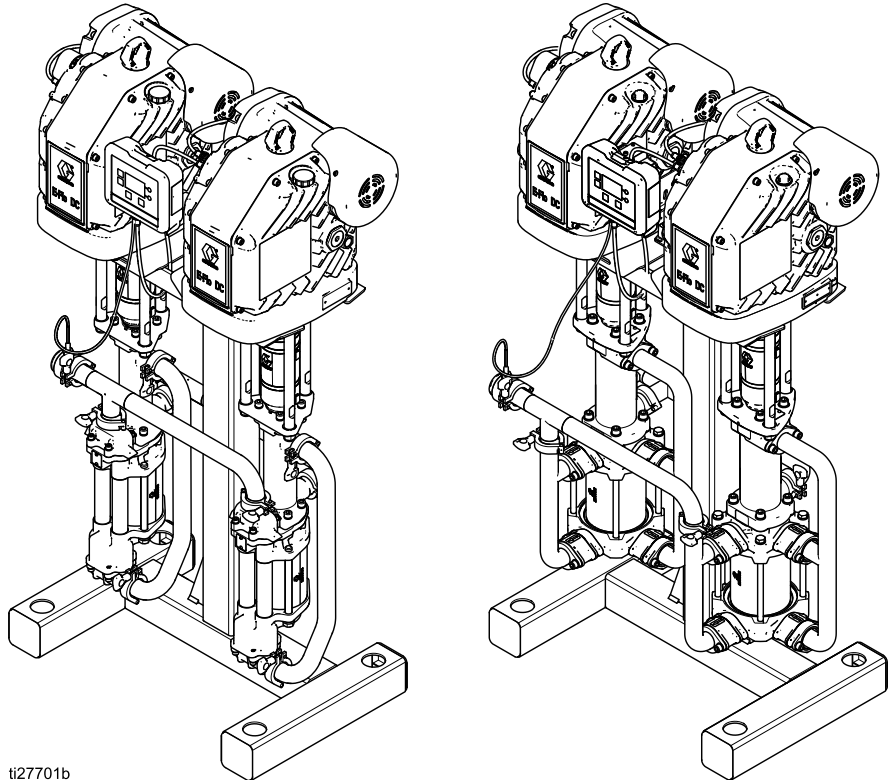

ti27701b

Contents

Related Manuals	2	Troubleshooting.....	45
Models.....	3	Error Code Troubleshooting	46
Warnings	4	Repair.....	49
Installation.....	7	Disassembly	49
Location	7	Reassembly	49
Mount the Pump	7	Parts.....	51
Install the Control Module	10	Pump Assembly.....	51
Connect the Control Module	10	Pump Matrix	55
Power Supply Requirements.....	11	24P822 Control Module Kit.....	56
Connect the Supply Wiring	14	Accessories.....	57
Power Supply Connections	15	Back Pressure Regulators	57
Grounding	16	Control Module	57
Fluid Line Accessories	16	Dimensions	58
Fill With Oil Before Using Equipment.....	16	Mounting Hole Patterns.....	59
Flush Before Using Equipment.....	16	Appendix A - Modbus Variable Map	60
Operation.....	17	Appendix B - Pump Control from a PLC	72
Startup	17	Appendix C - Control Module Programming	73
Shutdown	17	Software Upgrade Instructions	73
Pressure Relief Procedure.....	17	Notes	75
Control Module Overview	17	Performance Charts.....	76
Icons.....	20	Technical Data	79
Screen Navigation and Editing	21	Graco Standard Warranty.....	1
Initial Setup	21		
Screen Map.....	22		
Run Screens.....	25		
Setup Screens	28		
Maintenance	44		
Preventive Maintenance Schedule	44		
Flushing	44		

Related Manuals

Manual No.	Description
3A2526	Instructions-Installation Manual, E-Flo DC Motor
3A4409	Instructions-Installation Manual, E-Flo DC, Three Phase
3A2527	Instructions-Parts Manual, for E-Flo DC Control Module Kit
332013	Instructions-Parts Manual, for Advanced Display Control Module (ADCM)
333022	Repair/Parts Manual, Sealed 4-Ball Lowers
3A3452	Repair/Parts Manual, 4-Ball Lowers with Open Wet Cup
3A5348	Sealed 4-Ball Plus Lowers

Models

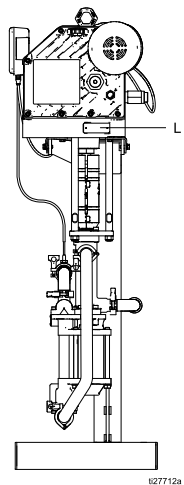

The part number for your equipment is printed on the equipment identification label (L). The part number includes digits from each of the following categories, depending on the configuration of your equipment.

Pump Type (EC)	Lower Size (4, 5, or 6)	Motor (9, 0, or J)	Lower Configuration (4 or 6)	Mounting Configuration (1)	
EC	4: 2000 cc	9: 2 Horsepower, ATEX • FM • IECEx	4: Sealed, tri-clamp	1 = Stand	
	5: 3000 cc	0: 2 Horsepower, ATEX • IECEx • TIIS • KCS	6: Open Wet Cup, tri-clamp		
	6: 4000 cc	J: 2 Horsepower, 3 Phase ATEX • FM • IECEx			

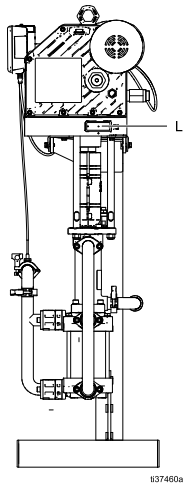
The part number for your equipment is printed on the equipment identification label (L). The part number includes digits from each of the following categories, depending on the configuration of your equipment.

Pump Type (EC)	Lower Size (8)	Motor (J)	Lower Configuration (4)	Mounting Configuration (1)	
EC	8: 5000 cc	J: 2 Horsepower, 3 Phase ATEX • FM • IECEx	4 = Sealed, tri-clamp	1 = Stand	

Approvals



ECx9xx Models ECx0xx Models	CE	 II 2 (1) G Ex db h [ja Ga] IIA T3 Gb X
ECxJxx Models	CE	 II 2 (1) G Ex db h [ja op is Ga] IIA T3 Gb X

NOTE: See the E-Flo DC Motor or Three Phase manual for motor approvals information.





Warnings

The following warnings are for the setup, use, grounding, maintenance, and repair of this equipment. The exclamation point symbol alerts you to a general warning and the hazard symbols refer to procedure-specific risks. When these symbols appear in the body of this manual or on warning labels, refer back to these Warnings. Product-specific hazard symbols and warnings not covered in this section may appear throughout the body of this manual where applicable.

DANGER









 	<p>SEVERE ELECTRIC SHOCK HAZARD</p> <p>This equipment can be powered by more than 240V. Contact with this voltage will cause death or serious injury.</p> <ul style="list-style-type: none"> Turn off and disconnect the power at the main switch before disconnecting any cables and before servicing equipment. This equipment must be grounded. Connect only to a grounded power source. All electrical wiring must be done by a qualified electrician and comply with all local codes and regulations.
--	--

WARNING

    	<p>FIRE AND EXPLOSION HAZARD</p> <p>Flammable fumes, such as solvent and paint fumes, in work area can ignite or explode. Paint or solvent flowing through the equipment can cause static sparking. To help prevent fire and explosion:</p> <ul style="list-style-type: none"> Use equipment only in well ventilated area. Eliminate all ignition sources; such as pilot lights, cigarettes, portable electric lamps, and plastic drop cloths (potential static sparking). Ground all equipment in the work area. See Grounding instructions. Never spray or flush solvent at high pressure. Keep work area free of debris, including solvent, rags and gasoline. Do not plug or unplug power cords, or turn power or light switches on or off when flammable fumes are present. Use only grounded hoses. Hold gun firmly to side of grounded pail when triggering into pail. Do not use pail liners unless they are anti-static or conductive. Stop operation immediately if static sparking occurs or you feel a shock. Do not use equipment until you identify and correct the problem. Keep a working fire extinguisher in the work area. <p>Static charge may build up on plastic parts during cleaning and could discharge and ignite flammable vapors. To help prevent fire and explosion:</p> <ul style="list-style-type: none"> Clean plastic parts only in well ventilated area. Do not clean with a dry cloth. Do not operate electrostatic guns in equipment work area.
--	--



WARNING

  	<p>PRESSURIZED EQUIPMENT HAZARD Fluid from the equipment, leaks, or ruptured components can splash in the eyes or on skin and cause serious injury.</p> <ul style="list-style-type: none"> • Follow the Pressure Relief Procedure when you stop spraying/dispensing and before cleaning, checking, or servicing equipment. • Tighten all fluid connections before operating the equipment. • Check hoses, tubes, and couplings daily. Replace worn or damaged parts immediately.
 	<p>EQUIPMENT MISUSE HAZARD Misuse can cause death or serious injury.</p> <ul style="list-style-type: none"> • Do not operate the unit when fatigued or under the influence of drugs or alcohol. • Do not exceed the maximum working pressure or temperature rating of the lowest rated system component. See Technical Data in all equipment manuals. • Use fluids and solvents that are compatible with equipment wetted parts. See Technical Data in all equipment manuals. Read fluid and solvent manufacturer's warnings. For complete information about your material, request Safety Data Sheet (SDS) from distributor or retailer. • Turn off all equipment and follow the Pressure Relief Procedure when equipment is not in use. • Check equipment daily. Repair or replace worn or damaged parts immediately with genuine manufacturer's replacement parts only. • Do not alter or modify equipment. Alterations or modifications may void agency approvals and create safety hazards. • Make sure all equipment is rated and approved for the environment in which you are using it. • Use equipment only for its intended purpose. Call your distributor for information. • Route hoses and cables away from traffic areas, sharp edges, moving parts, and hot surfaces. • Do not kink or over bend hoses or use hoses to pull equipment. • Keep children and animals away from work area. • Comply with all applicable safety regulations.
 	<p>MOVING PARTS HAZARD Moving parts can pinch, cut or amputate fingers and other body parts.</p> <ul style="list-style-type: none"> • Keep clear of moving parts. • Do not operate equipment with protective guards or covers removed. • Pressurized equipment can start without warning. Before checking, moving, or servicing equipment, follow the Pressure Relief Procedure and disconnect all power sources.
	<p>TOXIC FLUID OR FUMES Toxic fluids or fumes can cause serious injury or death if splashed in the eyes or on skin, inhaled, or swallowed.</p> <ul style="list-style-type: none"> • Read Safety Data Sheet (SDS) to know the specific hazards of the fluids you are using. • Store hazardous fluid in approved containers, and dispose of it according to applicable guidelines.



WARNING



BURN HAZARD

Equipment surfaces and fluid that's heated can become very hot during operation. To avoid severe burns:

- Do not touch hot fluid or equipment.



PERSONAL PROTECTIVE EQUIPMENT

Wear appropriate protective equipment when in the work area to help prevent serious injury, including eye injury, hearing loss, inhalation of toxic fumes, and burns. This equipment includes but is not limited to:

- Protective eyewear, and hearing protection.
- Respirators, protective clothing, and gloves as recommended by the fluid and solvent manufacturer.

Installation

<p>Installation of this equipment involves potentially hazardous procedures. Only trained and qualified personnel who have read and who understand the information in this manual should install this equipment.</p>				

Location

When selecting the location for the equipment, keep the following in mind:

- There must be sufficient space on all sides of the equipment for installation, operator access, maintenance, and air circulation.
- Ensure that the mounting surface and mounting hardware are strong enough to support the weight of the equipment, fluid, hoses, and stress caused during operation.
- There must be a start/stop control (C) within easy reach of the equipment. See [Typical Installation, page 12](#).

Mount the Pump

<p>During installation pumps could slide together causing a potential pinch hazard. Use caution when installing the pumps.</p>				

See [Figures 2 and 3](#).

1. Place each pump (4) onto the stand frame (6) and align the mounting holes of the motor stand bracket (2) with the stand frame (6). Install washers (13) and bolts (14) but do not tighten.

2. Install the inlet manifold (3). Place gaskets (15) over the inlet ports and attach manifold (3) using clamps (7).
3. Install the outlet manifold. Place gaskets (15) over the outlet ports and attach manifold (3) using clamps (7).
4. Install the o-ring (34c) and pressure transducer (34b) on the transducer manifold (34a). Use the gasket (34e) and clamp (34d) to attach the transducer assembly to the top manifold (3).
5. Tighten bolts (14) to secure the pumps to the stand.
6. **Models with Sealed Lower:** Install the shields (12) on both pumps by engaging the bottom lips with the groove in the top plate. Snap the two shields together.

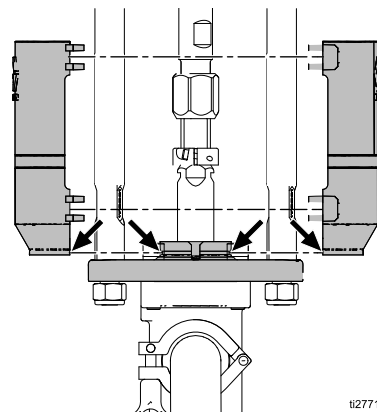
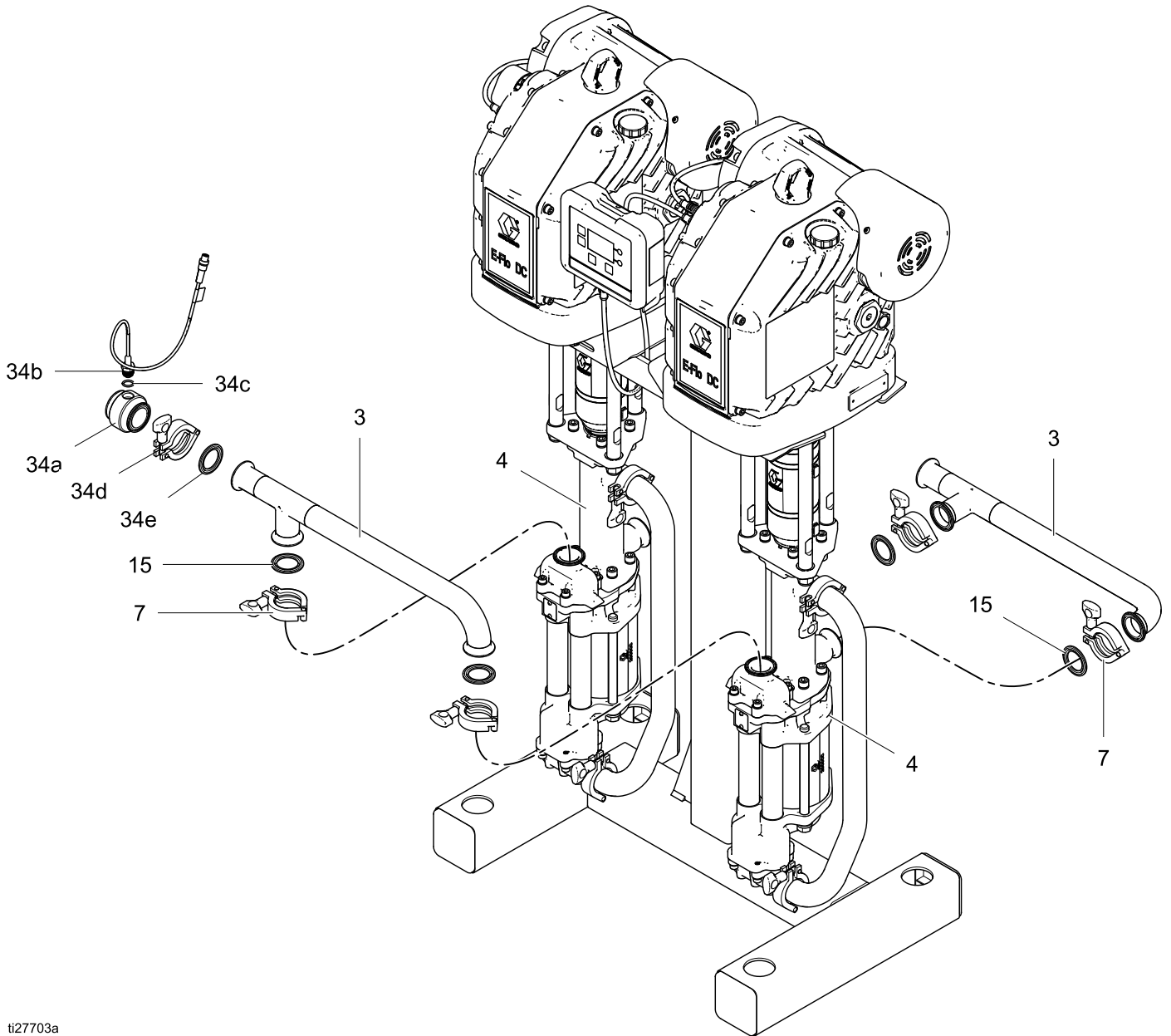

Figure 1

7. See [Mounting Hole Patterns, page 59](#). Secure the stand to the floor with M19 (5/8 in.) bolts which engage at least 152 mm (6 in.) into the concrete floor to prevent the pump from tipping.
8. Level the stand as required, using shims.

NOTICE

When lifting the full assembly use the lift rings on both motors. Failure to use both lift rings will cause the pump to become unbalanced, make it difficult to move, and could result in damage to the assembly.



ti27703a

Figure 2 Mount the Pump, with Sealed Bellows Lower

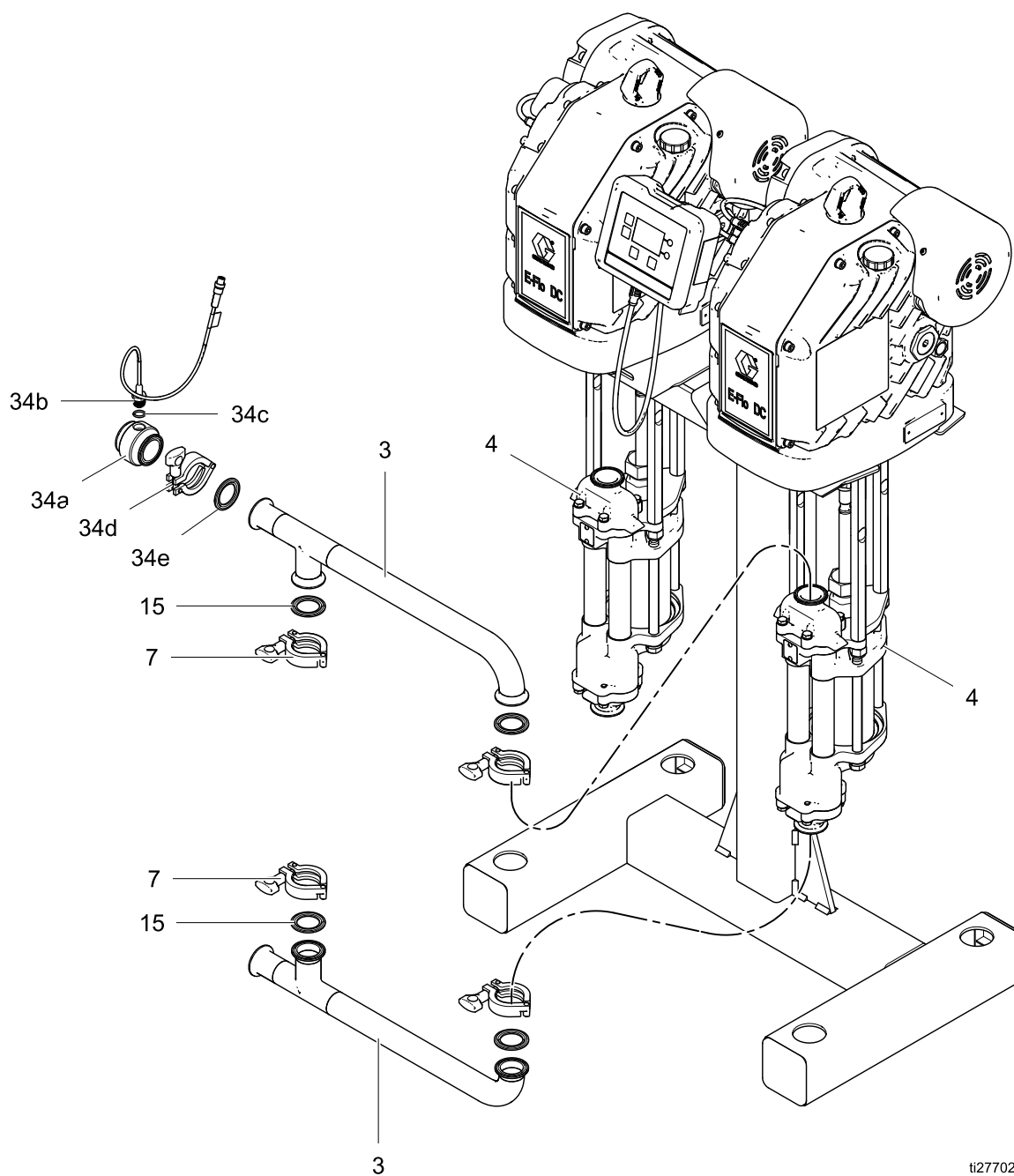

ti27702a

Figure 3 Mount the Pump, with Open Wet Cup Lower

Install the Control Module

1. Shut off and lock out power to the motor.
2. Assemble the bracket kit (6a-6f) and the holder and tie (11, 12) as shown.
3. Install the module (1) in the bracket (6a), making sure the tabs at the bottom of the bracket engage the slots in the module, and the lip at the top of the bracket holds the module securely in place.

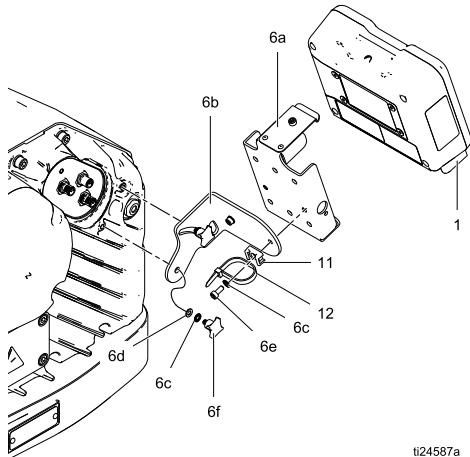

ti24587a

Figure 4 Install the Control Module

Connect the Control Module

1. If still on, shut off and lock out power to the motor.
2. Connect the gray end of the accessory cable (25) into port 3 on the bottom of the control module. Use the tie (12) as a strain relief. Connect the red end of the accessory cable (25) into power terminal (PT) 1 on the first motor.
3. Plug the gray end of the second accessory cable (25) into PT 2 on the first motor and the red end of the accessory cable (25) into PT 1 on motor 2.
4. Install the jumper connector (5) over PT 2 and PT 3 on motor 2, using the screw (5a).
5. Restore power to the motor.

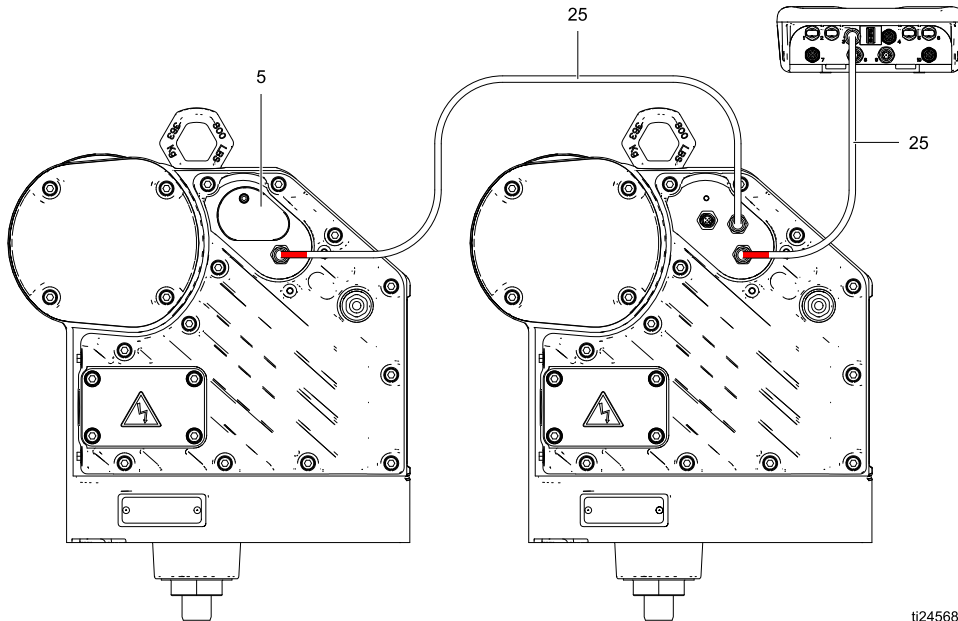

ti24568a

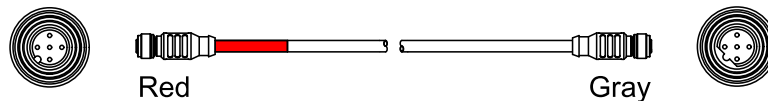

Figure 5 Connect the Control Module

Power Supply Requirements



				
<p>Improper wiring may cause electric shock or other serious injury if work is not performed properly. All electrical wiring must be done by a qualified electrician and comply with all local codes and regulations.</p>				

Table 1 . Power Supply Specifications

Model	Voltage	Phase	Hz	Power
ECx9xx ECx0xx	200–240 Vac	1	50/60	5.8 kVA (2.9 kVA per motor)
ECxJxx	380–480 Vac	3	50/60	6.0 kVA (3.0 kVA per motor)

Hazardous Area Cabling and Conduit Requirements

Explosion Proof

All electrical wiring in the hazardous area must be encased in Class I, Division I, Group D approved explosion-proof conduit. Follow all National, State, and Local electric codes.

A conduit seal (D) is required within 18 in. (457 mm) of the motor for the US and Canada. See [Typical Installation, page 12](#).

All cables must be rated at 70°C (158°F).

Flame Proof (ATEX)

Use appropriate conduit, connectors, and cable glands rated for ATEX II 2 G. Follow all National, State, and Local electric codes.

All cable glands and cables must be rated at 70°C (158°F).

Installation

Typical Installation

Table 2 Typical Installation — Pump with Sealed Bellows Lower

NON-HAZARDOUS LOCATION

HAZARDOUS LOCATION

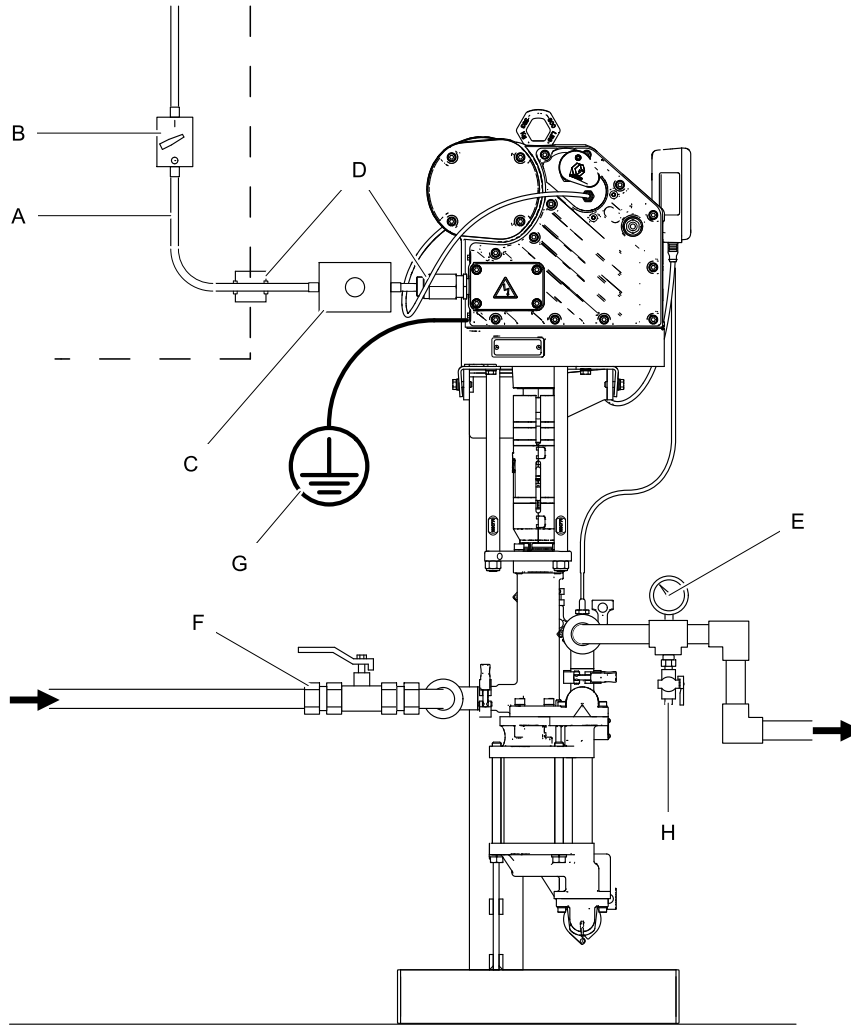

ti27713a

Table 3 Typical Installation — Pump with Open Wet Cup Lower

NON-HAZARDOUS LOCATION

HAZARDOUS LOCATION

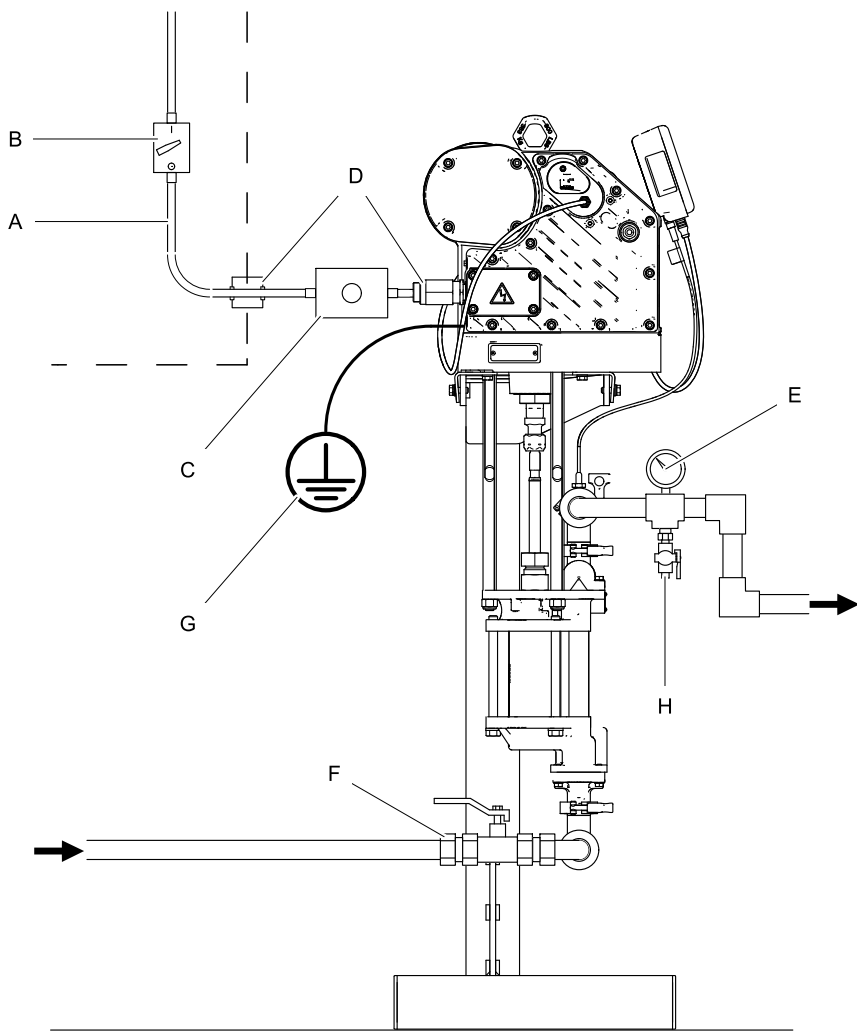

ti27714a



Key for Table 2 and Table 3	
A	Electrical Supply (must be sealed conduit approved for use in hazardous locations)
B	Fused Safety Switch, with lock
C	Start/Stop Control (must be approved for use in hazardous locations)
D	Explosion Proof Conduit Seal. Required within 18 in. (457 mm) of the motor for the US and Canada.

E	Fluid Pressure Gauge
F	Fluid Shutoff Valve
G	Pump Ground Wire. Two ground terminals are provided if local code requires redundant grounding connections.
H	Fluid Drain Valve

Connect the Supply Wiring

NOTE: For ECxJxx 3 Phase models, see manual 3A4409 for warnings and wiring installation instructions.

See Table 1 for power supply requirements for each individual motor. The system requires a dedicated circuit protected with a circuit breaker.

				
To avoid injury from fire, explosion, or electric shock, all electrical wiring must be done by a qualified electrician and comply with all local codes and regulations.				

1. Ensure that the fused safety switch (B) is shut off and locked out.

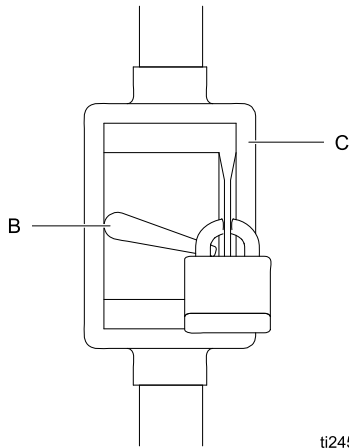

2. Install a start/stop control (C) in the electrical supply line (A), within easy reach of the equipment. The start/stop control must be approved for use in hazardous locations.

NOTE: The start/stop control can be wired to operate two motors. See [Power Supply Connections, page 15](#)

3. Open the electrical compartment (S) on the motor.
4. Bring the power wires into the electrical compartment through the 3/4–14 npt(f) inlet port. Connect the wires to the terminals, as shown in [Power Supply Connections, page 15](#). Torque the terminal nuts to 25 in-lb (2.8 N•m) maximum. **Do not over-torque.**
5. Close the electrical compartment. Torque the cover screws to 15 ft-lb (20.3 N•m).
6. Repeat the steps above for the second motor.

Power Supply Connections

Each motor connected to its own power drop

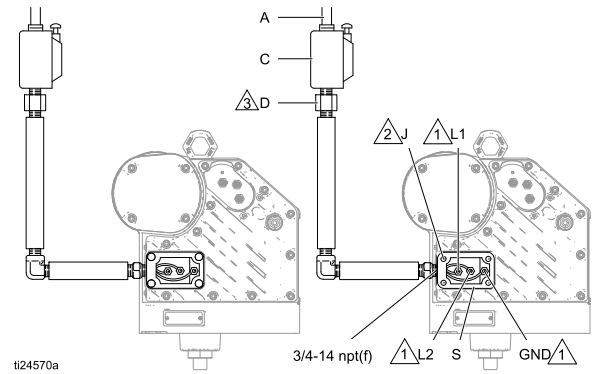
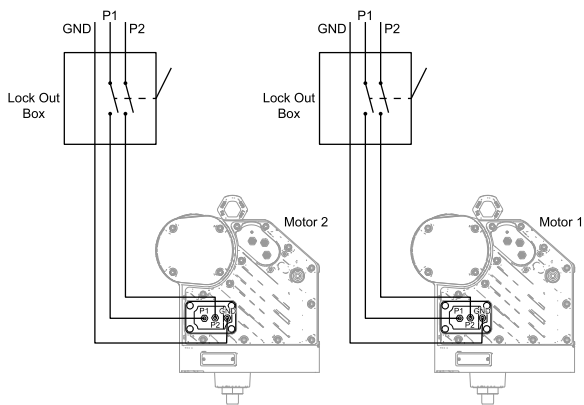



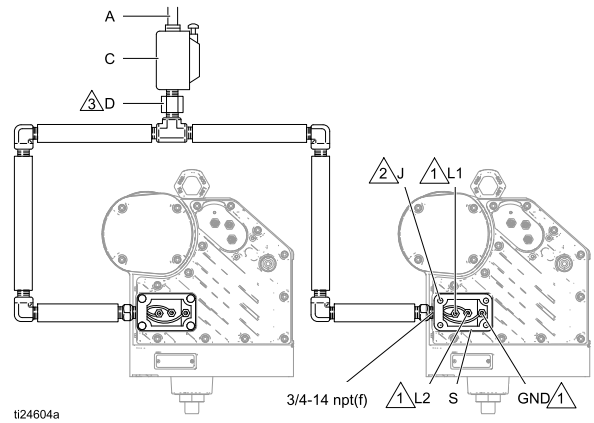
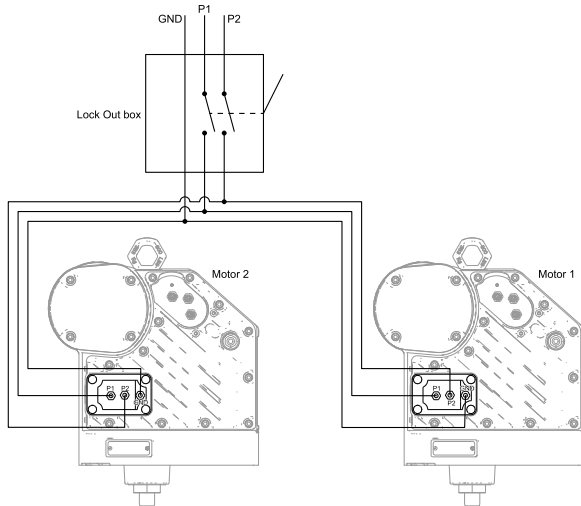

Two motors connected to a single power drop



- 1 Tighten all terminal nuts to 25 in-lb (2.8 N•m) maximum. **Do not over-torque.**
- 2 Tighten cover screws to 15 ft-lb (20.3 N•m).
- 3 A conduit seal (D) is required within 18 in. (457 mm) of the motor for the US and Canada.

Grounding

				
---	---	---	---	--

This equipment must be grounded to reduce the risk of static sparking and electric shock. Electric or static sparking can cause fumes to ignite or explode. Improper grounding can cause electric shock. Grounding provides an escape wire for the electric current.

1. **Pump:** Loosen the ground screw and attach a ground wire. Tighten the ground screw securely. Connect the other end of the ground wire to a true earth ground.

NOTE: Both pumps are connected to a common control module and must be grounded to the same ground point. Different ground points (unequal potential) may cause current to flow through component cables, causing incorrect signals.

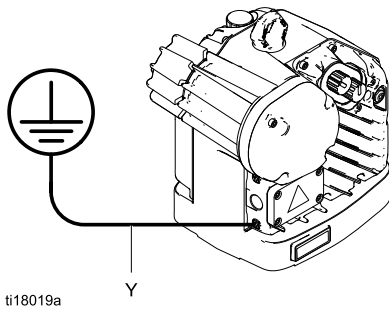

2. **Fluid hoses:** Use only electrically conductive hoses with a maximum of 500 ft. (150 m) combined hose length to ensure grounding continuity. Check the electrical resistance of hoses. If total resistance to ground exceeds 25 megohms, replace hose immediately
3. **Fluid supply container:** Follow your local code.
4. **Solvent pails used when flushing:** Follow local code. Use only conductive metal pails, placed on a grounded surface. Do not place the pail on a non-conductive surface, such as paper or cardboard, which interrupts grounding continuity.
5. **To maintain grounding continuity when flushing or relieving pressure:** Hold metal part of the spray gun or valve firmly to the side of a grounded metal pail, then trigger the gun or open the valve.

Fluid Line Accessories

Install the following accessories in the order shown in the [Typical Installation Diagram, page 12](#), using adapters as necessary.

NOTE: All fluid lines and accessories must be rated to the maximum working pressure of 400 psi (2.8 MPa, 28.0 bar).

- **Fluid drain valve (H):** required in your system, to relieve fluid pressure in the hose and circulation system.
- **Fluid pressure gauge (E):** for more precise adjustment of the fluid pressure.
- **Fluid shutoff valve (F):** shuts off fluid flow.

Fill With Oil Before Using Equipment

Before using the equipment, open the fill cap (P) and add Graco Part No. 16W645 ISO 220 silicone-free synthetic gear oil. Check the oil level in the sight glass (K). Fill until the oil level is near the halfway point of the sight glass. The oil capacity is approximately 1.5 quarts (1.4 liters). **Do not overfill.**

NOTE: Four 1 quart (0.95 liter) bottles of oil are supplied with the equipment.

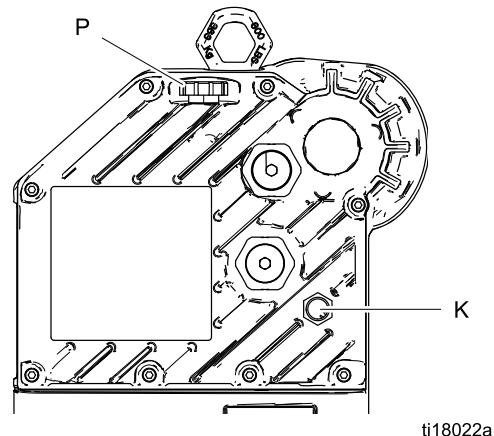

Flush Before Using Equipment

The pump fluid section was tested with lightweight oil, which is left in the fluid passages to protect parts. To avoid contaminating your fluid with oil, flush the equipment with a compatible solvent before using the equipment.

Operation

Startup

To operate the pump, follow the Startup instructions for the Advanced motor in the Motor manual.

Run the pump at a slow speed until the fluid lines are primed and all air is forced out of the system.

Shutdown

Follow the [Pressure Relief Procedure](#), page 17.

Pressure Relief Procedure



Follow the Pressure Relief Procedure whenever you see this symbol.



This equipment stays pressurized until pressure is manually relieved. To help prevent serious injury from splashing fluid and moving parts, follow the Pressure Relief Procedure when you stop spraying and before cleaning, checking, or servicing the equipment.

1. Disengage the start/stop control (C). See [Typical Installation](#), page 12.
2. Shut off and lock out the fused safety switch (B).
3. Open the fluid drain valve (H), having a waste container ready to catch drainage. Leave open until you are ready to pressurize system again.

Control Module Overview

The Control Module provides the interface for users to enter selections and view information related to setup and operation.

The screen backlight is set to turn off after 10 minutes of inactivity.

Keys are used to input numerical data, enter setup screens, navigate within a screen, scroll through screens, and select setup values.

Control Module Cable Connections

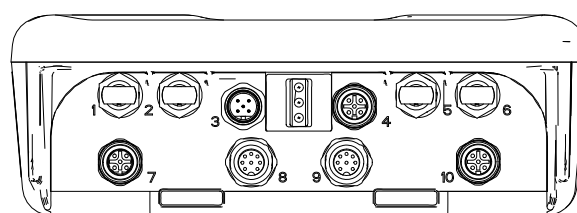

ti19093a

Control Module Port Number	Connector Purpose
1	Fiber Optic RX - to PLC
2	Fiber Optic TX - to PLC
3	Power and CAN communication
4	Start/stop input
5	Fiber Optic RX - to next ADCM
6	Fiber Optic TX - to next ADCM
7	Pressure transducer 1
8	BPR control 4-20mA output
9	Agitator control 4-20 mA output
10	Pressure transducer 2

Control Module Screens

The Control Module has two sets of screens: Run and Setup. For detailed information see [Run Screens, page 25](#), and [Setup Screens, page 28](#).

Press  to toggle between the Run screens and the Setup screens.

Control Module Keys

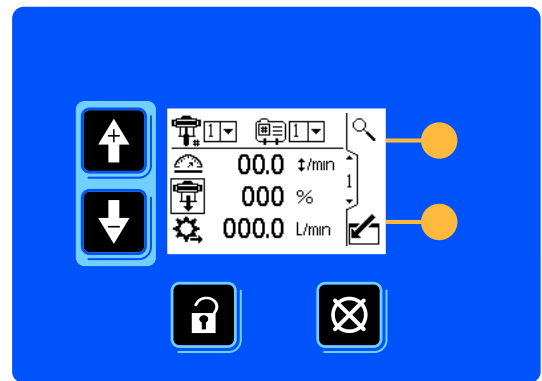

ti19866b











The above image shows a view of the control module display and keys.

NOTICE

To prevent damage to the softkey buttons, do not press the buttons with sharp objects such as pens, plastic cards, or fingernails.

























Table 4 explains the function of the membrane keys on the control module. As you move through the screens, you will notice that most information is communicated using icons rather than words to simplify global communication. The detailed screen descriptions in [Run Screens, page 25](#), and [Setup Screens, page 28](#), explain what each icon represents. The two softkeys are membrane buttons whose function correlates with the screen content to the immediate left of the button.

























Table 4 Module Keys

Membrane Keys	Softkeys
 <p>Press to toggle between Run screens and Setup screens.</p>	 <p><i>Enter Screen.</i> Highlight data that can be edited. Also changes the function of the Up/Down arrows so they move between data fields on the screen, rather than between screens.</p>
 <p><i>Error Reset:</i> Use to clear alarm after cause has been fixed. When there is no alarm to clear, this key will set the active pump's profile to Stop. Also used to cancel data entered and return to original data.</p>	 <p><i>Exit Screen.</i> Exit data editing.</p>
 <p><i>Up/Down Arrows:</i> Use to move between screens or fields on a screen, or to increment or decrement the digits in a settable field.</p>	 <p><i>Enter.</i> Press to activate a field for editing or to accept the highlighted selection on a dropdown menu.</p>
 <p><i>Softkeys:</i> Use varies by screen. See columns at right.</p>	 <p><i>Right.</i> Move to the right when editing number fields. Press again to accept the entry when all digits are correct.</p>
	 <p><i>Reset.</i> Reset totalizer to zero.</p>
	 <p><i>Activate Profile.</i> This softkey is disabled by default, and only appears if the Profile Lock box is checked on. Setup Screen 14, page 40. Press to activate the profile just edited.</p>

Icons

As you move through the screens, you will notice that most information is communicated using icons rather than words to simplify global communication. The detailed screen descriptions in [Run Screens, page 25](#), and [Setup Screens, page 28](#), explain what each icon represents.







Screen Icons	
 Speed	 Profile Number
 Pressure Control	 Cycles
 Pump Pressure	 Flow Rate
 Pressure	 Target
 In Setup Mode	 Mode Select
 Pressure Mode	 Flow Mode
 System Mode	 System Reset
 Lower Size	 Back Pressure Regulator
 Maximum Limit	 Minimum Limit
 Maximum and Minimum Limits	 Deviation Enable
 Alarm Enable	 Calibration
 Jog Mode	 Jog Up/Down

Screen Icons	
 Cycles Total	 Volume
 Maintenance	 Units
 Transducer	 Pressure Transducer Off
 Calibration Scale	 Zero Offset
 Serial Number	 Control Location
 Local Control	 PLC/Remote Control
 Modbus Device	 Modbus Address
 Serial Port	 Serial Baudrate
 Calendar	 Clock
 Password	 Lock Profile
 Enable Agitator Output	 Agitator Speed Setting
 Actual VFD Frequency	 Disable PLC/Network Control





Screen Navigation and Editing

Refer to this section if you have questions about screen navigation or about how to enter information and make selections.





All Screens

1. Use   to move between screens.
2. Press  to enter a screen. The first data field on the screen will highlight.
3. Use   to highlight the data you wish to change.
4. Press  to edit.

Drop Down Field



1. Use   to highlight the correct choice from the dropdown menu.
2. Press  to select.
3. Press  to cancel.

Number Field

1. The first digit will be highlighted. Use   to change the number.
2. Press  to move to the next digit.
3. When all digits are correct, press  again to accept.
4. Press  to cancel.

Check Box Field



A check box field is used to enable or disable features in the software.

1. Press  to toggle between  and an empty box.
2. The feature is enabled if a  is in the box.

Reset Field

The reset field is used for totalizers. Press  to reset the field to zero.

When all data is correct, press  to exit the screen.

Then use   to move to a new screen, or  to move between Setup screens and Run screens.

Initial Setup

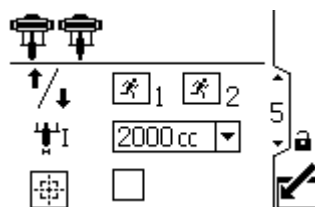

NOTE: Before creating the pump profiles in Setup Screens 1 through 4, you must set up the system parameters in Setup Screens 5 through 14, as follows.

1. Press  to enter the Setup screens. Setup Screen 1 will appear.
2. Scroll to Setup Screen 5.



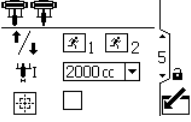
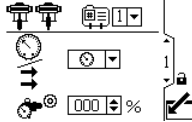
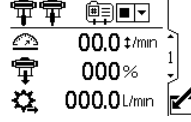
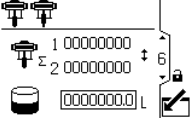
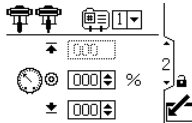
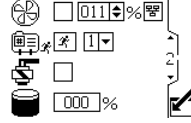
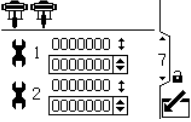
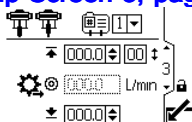
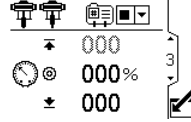
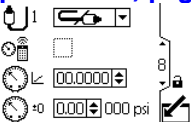

3. See [Setup Screen 5, page 34](#), and select the lower used in your system.
4. Continue setting the system parameters on [Setup Screen 6, page 35](#) through [Setup Screen 14, page 40](#).
5. Scroll to Setup Screen 1. Establish the profiles for each pump. See [Setup Screen 1, page 28](#) through [Setup Screen 4, page 32](#).
6. When the profiles are set to achieve the desired pressures and flow rates, start the pump. Go to [Setup Screen 5, page 34](#). Check the box next to  to perform an automatic system calibration. The system will learn its optimum settings over 21 cycles.

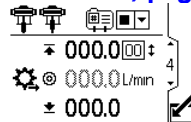
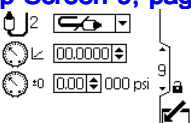
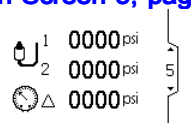
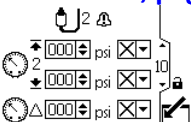
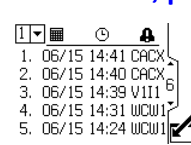
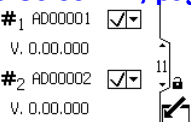
Screen Map

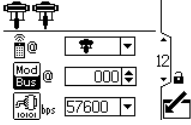
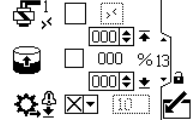
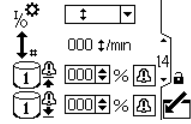
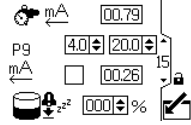
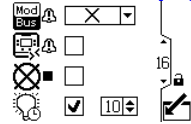
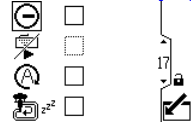
INITIAL SETUP (Setup Screens 5–14)	SETUP AND EDIT PROFILES (Setup Screens 1–4)	RUN (Run Screens 1–8)
<p>Setup Screen 5, page 34</p> 	<p>Setup Screen 1, page 28</p> 	<p>Run Screen 1, page 25</p> 
▼		
<p>Setup Screen 6, page 35</p> 	<p>Setup Screen 2, page 30</p> 	<p>Run Screen 2, page 26</p> 
▼		
<p>Setup Screen 7, page 35</p> 	<p>Setup Screen 3, page 31</p> 	<p>Run Screen 3, page 26</p> 
▼		
<p>Setup Screen 8, page 36</p> 	<p>Setup Screen 4, page 32</p> 	<p>Run Screen 4, page 27</p> 
▼		
<p>Setup Screen 9, page 37</p> 		<p>Run Screen 5, page 27</p> 
▼		
<p>Setup Screen 10, page 37</p> 		<p>Run Screens 6–9, page 27</p> 
▼		
<p>Setup Screen 11, page 38</p> 		
▼		

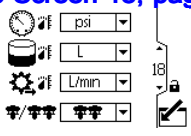
INITIAL SETUP (Setup Screens 5–14)	SETUP AND EDIT PROFILES (Setup Screens 1–4)	RUN (Run Screens 1–8)
<p>Setup Screen 12, page 38</p> 		
▼		
<p>Setup Screen 13, page 39</p> 		
▼		
<p>Setup Screen 14, page 40</p> 		
▼		
<p>Setup Screen 15, page 41</p> 		
▼		
<p>Setup Screen 16, page 41</p> 		
▼		
<p>Setup Screen 17, page 41</p> 		

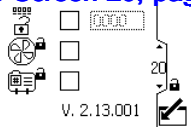
INITIAL SETUP (Setup Screens 5–14)	SETUP AND EDIT PROFILES (Setup Screens 1–4)	RUN (Run Screens 1–8)
▼		
<p>Setup Screen 18, page 42</p> 		
▼		
<p>Setup Screen 19, page 43</p> 		
▼		
<p>Setup Screen 20, page 43</p> 		

Run Screens

The Run screens display current target values and performance for a selected profile. Any alarms will display in the sidebar at the right of the screen. Screens 6–9 display a log of the last 20 alarms.

Information displayed on the Run screens corresponds to the Modbus Registers. See [Appendix A - Modbus Variable Map, page 60](#).

The active profile may be changed in Run Screens 1, 2, and 3.

Run Screen 1

This screen displays information for a selected profile. A box around an icon indicates which mode the profile is running (pressure or flow).

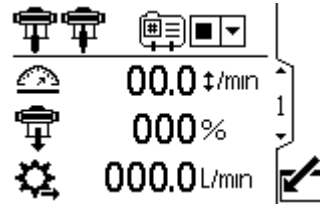

Figure 6 Run Screen 1

Run Screen 1 Key	
	Select the profile (1 to 4) from the menu. Select the stop option from the menu to stop the pump.
	Displays pump speed in cycles per minute.
	Displays pump pressure as a percentage. If a transducer is used, this icon is replaced by the pressure icon.
	Displays current flow rate, in units as selected in Setup Screen 18, page 42 .

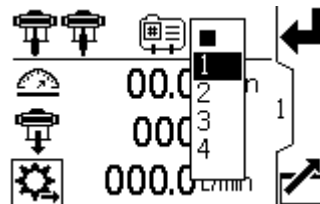

Figure 7 Select a Profile

Run Screen 2

This screen displays information for controlling an electric agitator using the supervisor to pass on the control set point to a Variable Frequency Drive (VFD), also known as an inverter.

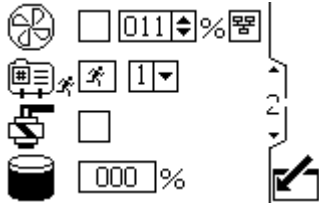

Figure 8 Run Screen 2

Run Screen 2 Key	
	Select this box and set the speed setpoint for the agitator from 0–100%.
	Select this box to disable network control of the agitator and prevent the IPK touch screen from modifying the Variable Frequency Drive/Inverter setpoint.
	Select this box and hold the softkey to manually run the pump in the selected profile. This feature allows the user to run the motor past the tank level low alarm to empty the tank.
	Select this box and hold the softkey button to manually control the fill pump solenoid output.
	Current primary tank volume in percent. The field is populated with data only when the tank sensor is enabled. See Setup Screen 14, page 40 .

Run Screen 3

This screen displays pressure settings for the active pump and profile.

NOTE: Some fields are grayed out, depending on setup selections.

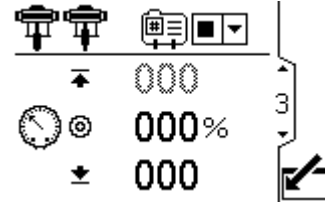

Figure 9 Run Screen 3

Run Screen 3 Key	
	Select the profile (1 to 4) from the menu.
	Select the stop option from the menu to stop the pump.
	Displays the target pressure as selected in Setup Screen 2, page 30 .

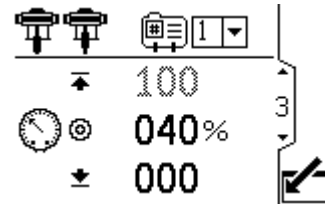

Figure 10 Run Screen 3, in Pressure Mode

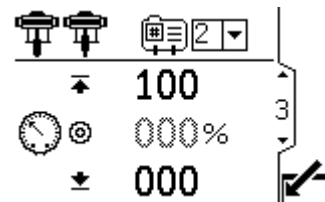

Figure 11 Run Screen 3, in Flow Mode

Run Screen 4

This screen displays fluid flow settings for the active profile.

NOTE: Some fields are grayed out, depending on setup selections.

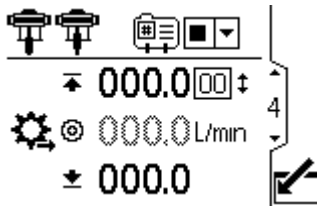

Figure 12 Run Screen 4

Run Screen 4 Key	
	Select the profile (1 to 4) from the menu. Select the stop option from the menu to stop the pump.
	Displays the target pressure as selected in Setup Screen 2, page 30 .

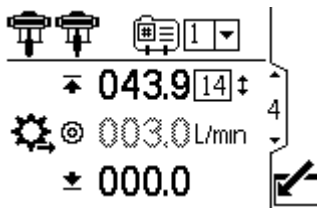

Figure 13 Run Screen 4, in Pressure Mode



Figure 14 Run Screen 4, in Flow Mode

Run Screen 5

This screen displays the current pressure readings of transducers 1 and 2. Pressure can be displayed as psi, bar, or MPa. See [Setup Screen 18, page 42](#).

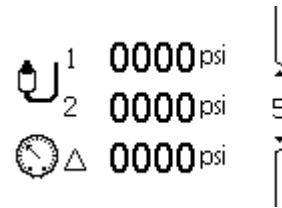

Figure 15 Run Screen 5

Run Screen 5 Key	
	Displays the pressure of transducer 1.
	Displays the pressure of transducer 2.
	Displays the pressure difference between transducer 1 and transducer 2.

Run Screens 6–9

Run Screens 6–9 (single or x2 parent pump) and 10–13 (x2 child pump) display a log of the last 20 alarms, with date and time. The currently active pump is displayed in a box at the top left of the screen. For error codes, see [Error Code Troubleshooting, page 46](#).



Figure 16 Run Screens 6–9 (Screen 6 shown)

Setup Screens

Use the Setup screens to set control parameters for the motor. See [Screen Navigation and Editing, page 21](#), for information on how to make selections and enter data.

Inactive fields are grayed-out on a screen.

Information displayed on the Setup screens corresponds to the Modbus Registers. See [Appendix A - Modbus Variable Map, page 60](#).

NOTE: Before setting up profiles on Setup Screens 1–4, do the initial setup on Setup Screens 5–14. Screens 5–14 establish the configuration for your system and affect the displayed data.

Setup Screen 1

Use this screen to set the operating mode for a profile.

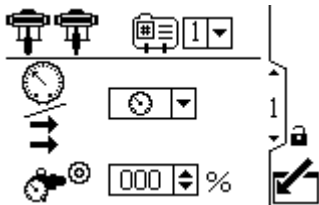

Figure 17 Setup Screen 1

Setup Screen 1 Key	
	Profile selection — See Step 1.
	<p>Select the operating mode (force/pressure or flow) from the menu — See Step 2.</p> <ul style="list-style-type: none"> In force/pressure mode, the motor adjusts the pump speed to maintain the fluid pressure percentage set on Setup Screen 2. If the flow limit is reached before the target pressure, the unit stops driving to the pressure (if set as an alarm). In flow mode, the motor maintains a constant speed to maintain the target flow rate set on Setup Screen 3, regardless of the fluid pressure, up to the pump’s maximum working pressure.
	<p>Setting for back pressure regulator — See Step 3.</p> <p>If the system is equipped with a back pressure regulator (BPR), set the target air pressure to the BPR from 0 to 100 percent (approximately 1 to 100 psi). Leave the field set to 000 for a system with no BPR. This value represents the percentage that is closed on the BPR. If the value is greater than zero but there is no BPR system, the L6CA error code appears.</p>
	<p>This softkey is disabled by default, and only appears if the Profile Lock box is checked on Setup Screen 20, page 43. Press to activate the profile just edited.</p>

1. Select the desired profile (1 to 4), using the pull-down menu.

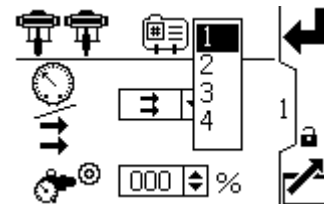

Figure 18 Select Profile Number

2. Select the desired operating mode (pressure or flow), using the pull-down menu.
 - In **pressure mode**, the motor will adjust the pump speed to maintain the fluid pressure percentage set on Setup Screen 2.
 - In **flow mode**, the motor will maintain a constant speed to maintain the target flow rate set on Setup Screen 3.

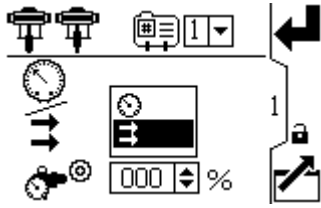

Figure 19 Select Mode (Pressure Mode Shown)

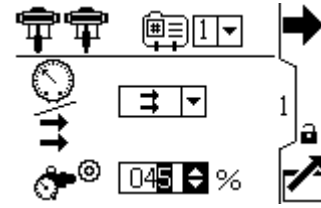

Figure 20 Set Back Pressure Regulator

3. If the system is equipped with a back pressure regulator (BPR) kit (P/N 24V001), set the target air pressure to the BPR from 0 to 100 percent (approximately 1 to 100 psi). Leave the field set to 000 for a system with no BPR.

Setup Screen 2

Use this screen to set the maximum, target, and minimum fluid pressure for a selected profile. In pressure mode, you will set a target fluid pressure. In flow mode, you will set a maximum fluid pressure. In either pressure or flow mode, a minimum pressure may be set if desired. See [Setup Screen 4, page 32](#), to specify how the system will respond if the pump begins to operate outside of the set boundaries.

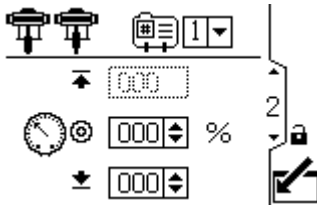
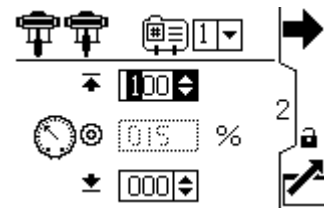

Figure 21 Setup Screen 2

Setup Screen 2 Key	
	Profile selection — See Step 2. Select the profile (1 to 4) from the menu.
	Fluid pressure maximum— See Step 3. In flow mode, set the maximum pump fluid force/pressure, as a percentage of the maximum pressure of your pump. This field is not used in pressure mode. NOTE: If the profile does not have a maximum pressure setting, the motor will not run and error code WSCX appears.
	Fluid pressure target — See Step 4. In force/pressure mode, set the force/fluid pressure target as a percentage of the maximum pressure of your pump. This field is not used in flow mode. NOTE: If closed loop pressure is enabled, the target pressure is displayed as a pressure value (psi, bar, MPa) rather than a percentage of maximum pressure. See Setup Screen 8, page 36 to enable closed loop pressure control.
	Fluid pressure minimum — See Step 5. Optionally, set a minimum pump force/fluid pressure, as a percentage of the maximum force/fluid pressure of your pump.
	This softkey is disabled by default, and only appears if the Profile Lock box is checked on Setup Screen 20, page 43 . Press to activate the profile just edited.

NOTE: If closed loop pressure is enabled, the pressure will be displayed as a pressure value rather than a percentage of maximum pressure. See [Setup Screen 8, page 36](#) to enable closed loop pressure control.

1. Select the desired profile (1 to 4), using the pull-down menu.
2. In **flow mode**, set the desired maximum pump fluid pressure, as a percentage of the maximum pressure of your pump.
NOTE: The motor will not run if the profile does not have a maximum pressure setting. This field is not used in pressure mode.



3. In **pressure mode**, set the desired fluid pressure target as a percentage of the maximum pressure of your pump. This field is not used in flow mode.

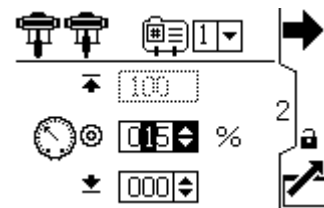

4. If desired, set a minimum pump fluid pressure, as a percentage of the maximum fluid pressure of your pump.

Setup Screen 3

Use this screen to set your flow rate settings for a selected profile. In pressure mode, you will set a maximum flow rate. In flow mode, you will set a target flow rate. In either pressure or flow mode, a minimum flow rate may be set if desired. See Setup Screen 4 to specify how the system will respond if the pump begins to operate outside of the set boundaries.

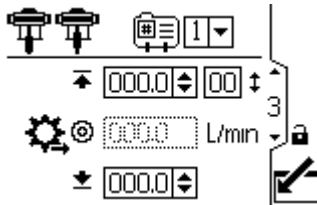

Figure 22 Setup Screen 3

Setup Screen 3 Key	
	Profile selection — See Step 2.
	Flow rate maximum — See Step 3.
	Flow rate target — See Step 4. In pressure mode, set the maximum flow rate. The software calculates the number of pump cycles needed to achieve that flow rate. This field is not used in flow mode. NOTE: If the profile does not have a maximum flow rate setting, the motor will not run and error code WSC_ appears.
	Flow rate minimum — See Step 5.
	This softkey is disabled by default, and only appears if the Profile Lock box is checked on Setup Screen 20, page 43 . Press to activate the profile just edited.

1. Select the desired profile (1 to 4), using the pull-down menu.
2. **In flow mode**, set a target flow rate. This field is not used in pressure mode.

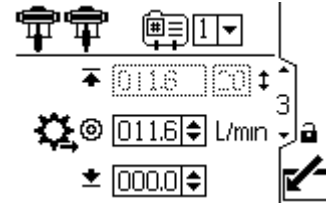

Figure 23 Flow Mode: Flow Rate Settings

3. **In pressure mode**, set the maximum flow rate. The software will calculate the number of pump cycles needed to achieve that flow rate. This field is not used in flow mode.

NOTE: The motor will not run if the profile does not have a maximum flow rate setting.

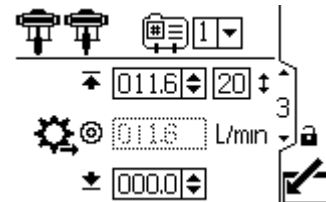

Figure 24 Pressure Mode: Flow Rate Settings

4. If desired, set a minimum flow rate.

Setup Screen 4

Use this screen to specify how the system will respond if the pump begins to operate outside of the pressure and flow settings established on Setup Screen 2 and Setup Screen 3. The operating mode (pressure or flow, set on Setup Screen 1) determines which fields are active.

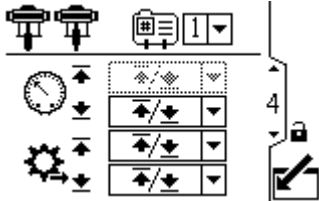

Figure 25 Setup Screen 4

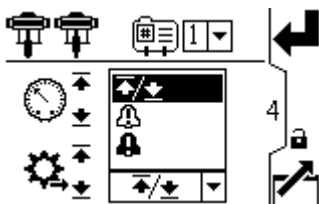

Figure 26 Alarm Preference Menu

- **Limit:** The pump continues to run and issues no alert.
 - Maximum pressure set to Limit: The system reduces the flow if necessary to prevent the pressure from exceeding the limit.
 - Maximum flow set to Limit: The system reduces the pressure if necessary to prevent the flow from exceeding the limit.
 - Minimum pressure or flow set to Limit: The system takes no action. Use this setting if no minimum pressure or flow setting is desired.
- **Deviation:** The system alerts you to the problem, but the pump may continue to run past the maximum or minimum settings until the system’s absolute pressure or flow boundaries are reached.
- **Alarm:** The system alerts you to the alarm cause and shuts down the pump.

Setup Screen 4 Key	
	<p>To enable the pressure alarm:</p> <ul style="list-style-type: none"> • Line 1 (Pressure Maximum): Select Limit, Deviation, or Alarm. For runaway control, set the maximum flow to Alarm. If the flow rate exceeds the maximum entered on Setup Screen 3 for five seconds, an alarm symbol appears on the screen and the pump shuts down. • Line 2 (Pressure Minimum): Select Limit, Deviation, or Alarm. To detect a plugged filter or pipe, set the minimum flow to Deviation. If the flow rate drops below the minimum entered on Setup Screen 3, a deviation symbol appears on the screen to warn you to take action. The pump continues to run.
	<p>To enable the flow rate alarm:</p> <ul style="list-style-type: none"> • Line 3 (Flow Maximum): Select Limit, Deviation, or Alarm. To prevent the connected equipment from excessive pressure, set the maximum pressure to Limit. • Line 4 (Flow Minimum): Select Limit, Deviation, or Alarm. For runaway control, set the minimum pressure to Alarm. If a hose bursts, the pump does not change speed, but the back pressure falls. When the pressure falls below the minimum entered on Setup Screen 2, an Alarm symbol appears on the screen and the pump shuts down. To detect a plugged filter or pipe, set the maximum pressure to Deviation. When the pressure exceeds the maximum entered on Setup Screen 2, a Deviation symbol appears on the screen to warn you to take action. The pump continues to run.
	Press to accept the selections.
	This softkey is disabled by default, and only appears if the Profile Lock box is checked on Setup Screen 20, page 43 . Press to activate the profile just edited.

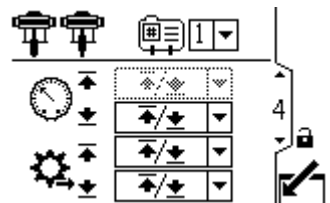

Figure 27 Setup Screen 4 (In Pressure Mode)

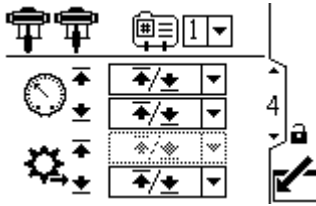





Figure 28 Setup Screen 4 (In Flow Mode)

Pressure Mode Examples

- **Runaway Control:** The user may choose to set the maximum flow to Alarm. If the flow rate exceeds the maximum entered on Setup Screen 3, an Alarm symbol  will show on screen and the pump will shut down.
- **Detect a Plugged Filter or Pipe:** The user may choose to set the minimum flow to Deviation. If the flow rate drops below the minimum entered on Setup Screen 3, a Deviation symbol  will show on screen to warn the user that action should be taken. The pump continues to run.

Flow Mode Examples

- **Runaway Control:** The user may choose to set the minimum pressure to Alarm. If a hose bursts, the pump will not change speed, but the back pressure will fall. When the pressure falls below the minimum entered on Setup Screen 2, an Alarm symbol  will show on screen and the pump will shut down.
- **Protect Connected Equipment:** The user may choose to set the maximum pressure to Limit to prevent the connected equipment from excessive pressure.
- **Detect a Plugged Filter or Pipe:** The user may choose to set the maximum pressure to Deviation. When the pressure exceeds the maximum entered on Setup Screen 2, a Deviation symbol  will show on screen to warn the user that action should be taken. The pump continues to run.

Setup Screen 5

Use this screen to set the lower pump size (cc) of the system. The default is blank; select the correct lower size. This screen also activates jog mode, allowing you to position the motor/pump shaft for connection or disconnection. The screen also allows you to initiate an automatic system calibration when the pump is running a profile.

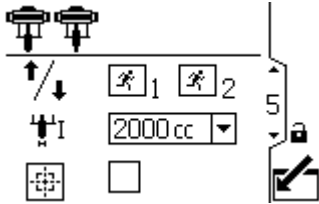

Figure 29 Setup Screen 5

Setup Screen 5 Key	
	Select to enable jog mode. Use the arrow keys to move the motor/pump shaft up or down.
	Select the correct pump lower size from the drop-down menu. The default is blank. If custom is selected, a field will open to input the size of the lower in cc.
	Select to initiate automatic system calibration. The pump must be running a profile prior to selection for the calibration procedure to work. NOTE: Make sure the pumps are primed before initiating the calibration.

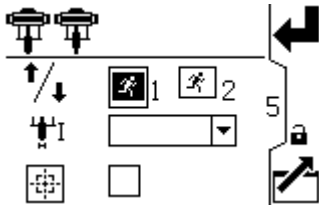

Figure 30 Select Jog Mode

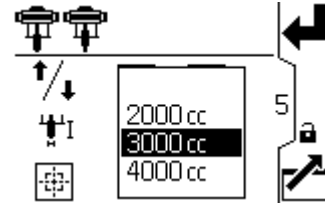

Figure 31 Select Pump Lower

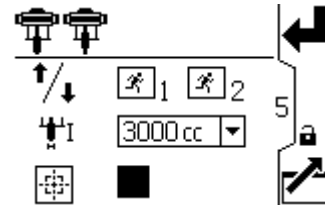

Figure 32 Initiate Automatic System Calibration

NOTE: When an automatic system calibration is initiated, the system causes the display to bring up a new screen for showing the progress of the calibration. The progress bar increments with each pump cycle. The display returns to Setup Screen 5 when the calibration is complete or is stopped manually.

Press or to cancel the calibration.

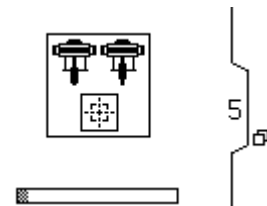

Figure 33 System Calibration Progress Screen

Setup Screen 6

Use this screen to view the grand totalizer value and set or reset the batch totalizer.

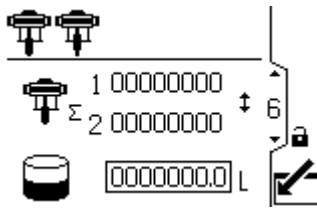

Figure 34 Setup Screen 6

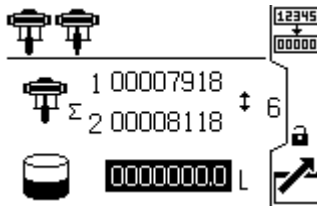

Figure 35 Reset the Totalizer

Setup Screen 6 Key	
	Grand Totalizer - displays the current grand total of pump cycles. Not resettable.
	Batch Totalizer - displays the batch total in selected volume units.
	Reset Batch Totalizer - resets the batch totalizer to zero.

Setup Screen 7

Use this screen to set the desired maintenance interval (in cycles) for each pump. The screen also displays the current cycle count. An Advisory is issued when the counter reaches 0 (zero).

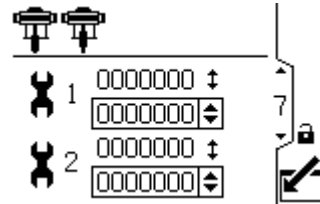

Figure 36 Setup Screen 7

Setup Screen 7 Key	
	Set the desired maintenance interval (in cycles) for each pump.

Setup Screen 8

Use this screen to set up the pressure for transducer 1. Selecting a transducer and checking the pressure control checkbox activates closed loop pressure control.

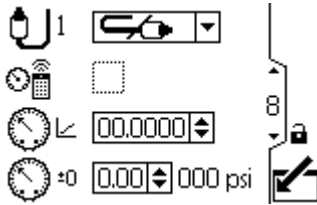

Figure 37 Setup Screen 8

Setup Screen 8	
	Select from the dropdown options to enable the transducer.
	Enables the pump to use the transducer to control to a pressure setpoint (psi/bar/mpa, rather than %force)
	Enter the calibration scale factor from the transducer label.
	Enter the calibration offset value from the transducer label.
000 psi	Displays the current transducer reading.

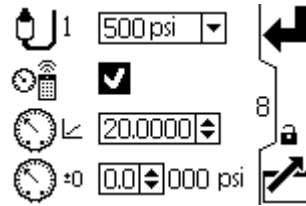

Figure 39 Closed Loop Pressure Enable

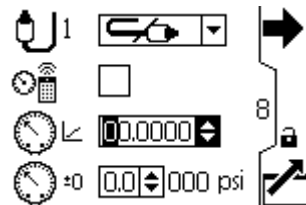

Figure 40 Enter Calibration Scale Factor

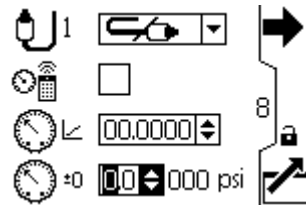

Figure 41 Enter Calibration Offset Value

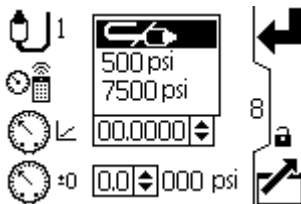

Figure 38 Select Pressure Transducer

Setup Screen 9

Use this screen to set up the pressure for transducer 2.

To activate closed loop pressure control, see [Setup Screen 8, page 36](#).

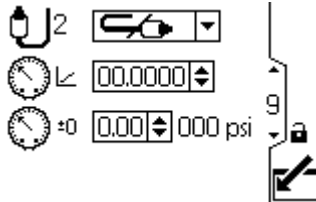

Figure 42 Setup Screen 9

Setup Screen 9 Key	
	Select from the menu options (500 psi or 5000 psi) to enable the transducer.
	Enter the calibration scale factor from the transducer label.
	Enter the calibration offset value from the transducer label.
000 psi	Displays the current transducer reading.

Setup Screen 10

Use this screen to specify how the system responds if the system pressure begins to operate outside of the system settings.

Pressure transducer 2 monitors the pressure at the BPR.

Delta pressure monitors the difference between the pump outlet and the BPR.

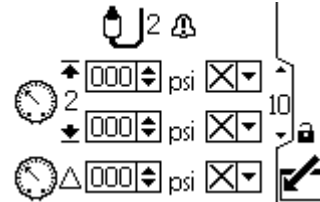

Figure 43 Setup Screen 10

The following events can appear:

- No event:** The pump continues to run and issues no alert.
- Deviation:** The system alerts you to the problem, but the pump may continue to run past the maximum or minimum settings for five seconds until the system's absolute pressure or flow boundaries are reached.
- Alarm:** The system alerts you to the alarm cause and shuts down the pump.

Setup Screen 10 Key	
	Maximum and minimum pressure. Can be configured as no event, deviation, or alarm.
	Pressure difference between transducer 1 and 2.

Setup Screen 11

This screen is auto-populated with the serial numbers and software versions for each motor.

In this system there is a parent motor and a child motor. The parent motor controls itself to the active profile setpoints while the child follows. The first serial number listed on this screen corresponds to the parent and the second to the child.

NOTE: These serial numbers match the name plates attached to the side of the motor.

Each motor can be run individually by disabling the other (X in the selection box).

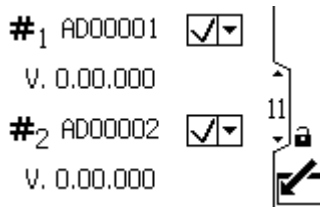

Figure 44 Setup Screens 11

Setup Screen 12

Use this screen to set your modbus preferences.

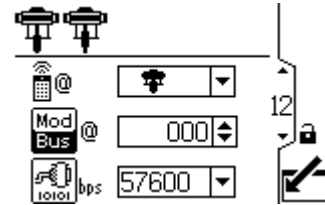

Figure 45 Setup Screen 12

Setup Screen 12 Key	
	Control location. Select local or remote control from the dropdown options. Setting applies to the selected pump only.
	Enter or change the Modbus node ID. Value is between 1 and 247. Each pump requires a unique node ID, which identifies that pump if more than one pump is connected to the display.
	Select serial port baud rate from the dropdown options: 38400, 57600, or 115200. This is a system-wide setting.

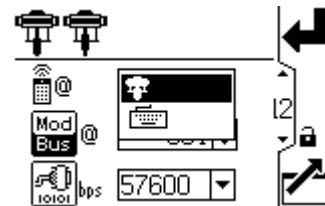

Figure 46 Select Local or Remote Control

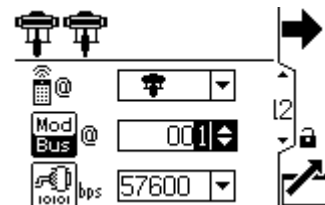

Figure 47 Set Modbus Node ID



Figure 48 Set Baud Rate (Bits Per Second)

NOTE: The following are fixed modbus settings, which cannot be set or changed by the user: 8 data bits, 2 stop bits, no parity.

Setup Screen 13

Use this screen to configure and control the tank fill feature and Intelligent Paint Kitchen peripherals.

NOTE: The alert trigger time varies based on how far active measurements are from their set limits.

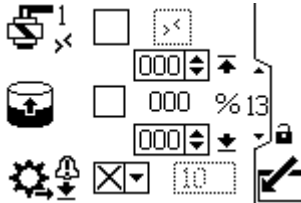

Figure 49 Setup Screen 13

Setup Screen 13 Key	
	Select this box to manually activate the fill solenoid output on port 4, pin 3. NOTE: The non-editable box shows the status of the modbus register.

	Select this box to enable the tank to automatically fill. You can then set the fill levels. ↑ % When the tank level reaches this level, the fill solenoid turns off. This value cannot be higher than the level below. ↓ % When the tank level reaches this level, the fill solenoid turns on. This value cannot be lower than the level above.
	Configure the low fill pump flow notification for a deviation or an alarm and set the time-out value in seconds. If a 1% level change is not detected with the timeout period in seconds, the system takes action based on the event type.

Setup Screen 14

Use this screen to monitor, set up, and control the Intelligent Paint Kitchen peripherals. For more information, see the Set Up Peripherals section of the Intelligent Paint Kitchen manual 3A4030.

NOTE: The second field varies, depending on the menu selection in the first field.

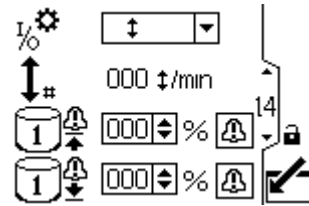

Figure 50 Setup Screen 14

Setup Screen 14 Key	
	Select the connected peripheral from the menu.
	Configures Port 4 pin 4 as an input to allow a reed switch to be connected. The current reed switch cycle rate appears next to the cycle rate icon in cycles per minute.
	Configures Port 4 pin 4 as an input to allow a pressure switch to be connected. If the drum cover is lifted while this configuration is properly connected, the agitator shuts down. The current input status appears in the agitator status field . NOTE: A Supervisor Module is required for this function.
	Configures Port 4 pin 4 as an output to allow for the connected device to receive an alarm when the level of the Primary Tank is above the value that is defined in the Primary Tank High field %. This value is a percentage of the total level of the Primary Tank.
	Configures Port 4 pin 4 as an output to allow for the connected device to receive an alarm when the level of the Primary Tank is below the value that is defined in the Primary Tank Low field %. This value is a percentage of the total level of the Primary Tank
	Configures Port 4 pin 4 as an output to allow for another solenoid to be connected and controlled from the device. Select the manual output box <input type="checkbox"/> <input checked="" type="checkbox"/> and hold the button to control the auxiliary solenoid manually. After you release the button, the manual activation is terminated.
	Allows for the connected device to receive an alarm when the level of the primary tank is above the value that is defined in this field. If the value is set to 0, the event is disabled.
	Allows for the connected device to receive an alarm when the level of the primary tank is below the value that is defined in this field. If the value is set to 0, the event is disabled.
	An event can be configured as a deviation or an alarm. In the event of an alarm, the pump shuts off and the agitator turns off.

Setup Screen 15

Use this screen to set up the input scaling (radar level sensor) for 4–20mA devices and turn on the current loop (Port 8 and Port 9 of the ADCM).

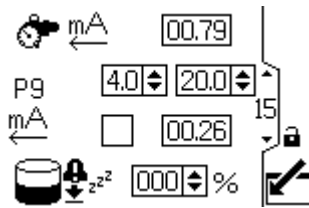

Figure 51 Setup Screen 15

Setup Screen 15 Key	
	Monitor the back pressure regulator mA output.
P9	Set the value for P9 (Port 9) between 4 and 20.
mA	Select this box to turn on the 4-20mA supply. Set the numerical values for the scaling ceiling for 4-20mA signal.
	Current off production tank level. See Setup Screen 17, page 41

Setup Screen 16

This screen is for enabling a modbus communications alarm and disabling the Stop Pump function of the Cancel key.

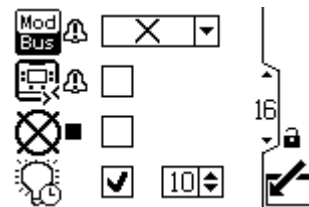

Figure 52 Setup Screen 16

Setup Screen 16 Key	
	Select the modbus alarm type: X None Deviation Alarm
	Select this box to make CAN communication a deviation that does not shut down the pump.
	Select this box to disable the Stop Pump function of the Reset/Cancel key.
	Enable or disable the backlight and set the time-out value in minutes.

Setup Screen 17

Use this screen to enable or disable the run/stop switch and auto restart.

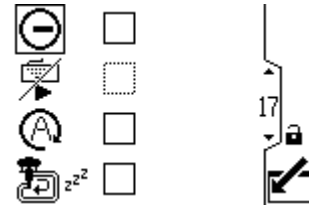

Figure 53 Setup Screen 17

Setup Screen 17 Key	
	Enable or disable the run/stop switch. The default setting is disabled. See Run/Stop Switch Kit in Accessories, page 57 . When enabled, this configuration allows the run/stop switch to pause the pump while in a profile. When the run/stop switch is active, the following pop-up appears:
	Disable the remote start function over modbus. When enabled along with the run/stop switch, you must toggle the run/stop switch when going from profile 0 (stopped) to run before the pump can start. When the run/stop switch is active, the following pop-up appears:
	Enable or disable auto restart. The default setting is disabled. If enabled, the unit resumes operation at the profile that was set before the unit was turned off.
	Enable off production profile mode. This feature turns profile 4 into the off production profile. When profile 4 is active, the fill pump is disabled and the current primary tank level is recorded. If the primary tank level drops more than 3%, the system triggers the alarm and shuts off the pump.

Setup Screen 18

Use this screen to set the units for pressure, totals, and flow.

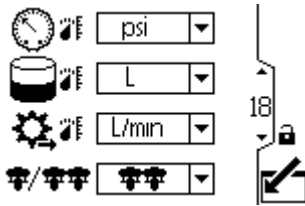

Figure 54 Setup Screen 18

Setup Screen 18 Key	
	Select the pressure units: <ul style="list-style-type: none"> • psi • bar (default) • MPa
	Select the volume units: <ul style="list-style-type: none"> • liters (default) • gallons • cc
	Select the flow rate units: <ul style="list-style-type: none"> • L/min (default) • gpm • cc/min • oz/min • cycles/min
	Select the system mode (1 pump or 2 pumps).



Figure 55 Select Desired Pressure Units

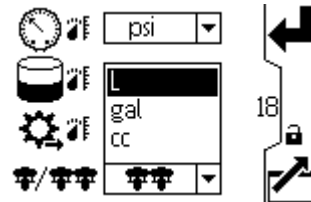

Figure 56 Select Desired Volume Units

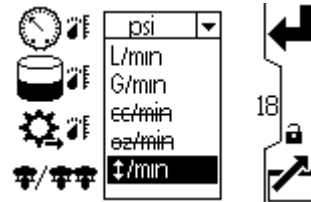

Figure 57 Select Desired Flow Rate Units

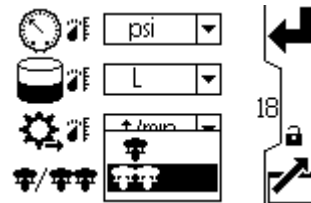

Figure 58 Select Desired System Mode

Setup Screen 19

Use this screen to set your date format, date, time, or force a restart of the system when updating the software (update token inserted into the display). After the software update is completed successfully, the token must be removed prior to selecting the Acknowledge key or power cycling the display. If an update was concluded and the token is not removed, pressing the Acknowledge key restarts the update process.

NOTE: Refer to [Appendix C - Control Module Programming, page 73](#) for instructions on software updating. Software update is disruptive to all pumps connected to the display. All pumps attached to the display must not be pumping material when the software update is initiated.

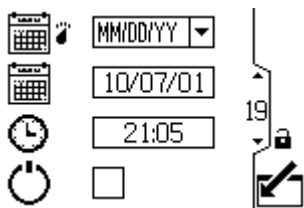

Figure 59 Setup Screen 19

Setup Screen 19 Key	
	Select your preferred date format from the menu. <ul style="list-style-type: none"> • MM/DD/YY • DD/MM/YY (default) • YY/MM/DD
	Set the correct date.
	Set the correct time.
	Perform a soft restart of the system.

Setup Screen 20

Use this screen to enter a password that will be required to access the Setup screens. This screen also displays the software version.

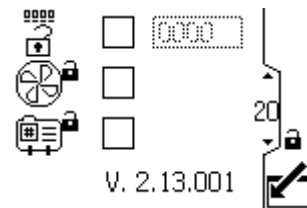

Figure 60 Setup Screen 20

Setup Screen 20 Key	
<input checked="" type="checkbox"/>	When the top box of the screen is checked, the password is active. To temporarily disable the password, uncheck the box. The password field will be grayed-out.
	Enter the desired 4-digit password.
<input checked="" type="checkbox"/>	Check the box to lock out the profile field in the Run screens.

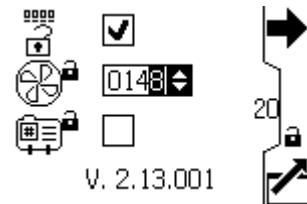

Figure 61 Set the Password

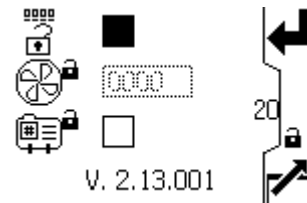

Figure 62 Disable the Password

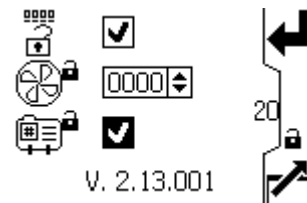

Figure 63 Lock the Profile

Maintenance

See the motor manual for required motor maintenance procedures.

Preventive Maintenance Schedule

The operating conditions of your particular system determine how often maintenance is required. Establish a preventive maintenance schedule by recording when and what kind of maintenance is needed, and then determine a regular schedule for checking your system.

Flushing

				
<p>To avoid fire and explosion, always ground equipment and waste container. To avoid static sparking and injury from splashing, always flush at the lowest possible pressure.</p>				

- Flush before changing fluids, before fluid can dry in the equipment, at the end of the day, before storing, and before repairing equipment.
- Flush at the lowest pressure possible. Check connectors for leaks and tighten as necessary.
- Flush with a fluid that is compatible with the fluid being dispensed and the equipment wetted parts.

Troubleshooting

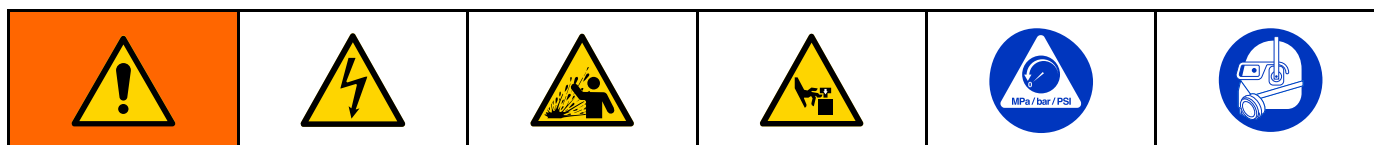



NOTE: Check all possible remedies before disassembling the pump.

NOTE: The LED on the motor will blink if an error is detected. See **Error Code Troubleshooting** in the motor manual for further information.

Problem	Cause	Solution
Pump output low on both strokes.	Inadequate power supply.	See Power Supply Requirements, page 11 .
	Exhausted fluid supply.	Refill and reprime pump.
	Clogged fluid outlet line, valves, etc.	Clear.
	Worn piston packing.	Replace. See lower manual.
Pump output low on only one stroke.	Held open or worn ball check valves.	Check and repair. See lower manual.
	Worn piston packing.	Replace. See lower manual.
No output.	Improperly installed ball check valves.	Check and repair. See lower manual.
Pump operates erratically.	Exhausted fluid supply.	Refill and reprime pump.
	Held open or worn ball check valves.	Check and repair. See lower manual.
	Worn piston packing.	Replace. See lower manual.
Pump will not operate.	Inadequate power supply.	See Power Supply Requirements, page 11 .
	Exhausted fluid supply.	Refill and reprime pump.
	Clogged fluid outlet line, valves, etc.	Clear.
	Fluid dried on piston rod.	Disassemble and clean pump. See lower manual. In future, stop pump at bottom of stroke.

Error Code Troubleshooting

Error codes can take three forms:

- Alarm  : alerts you to the alarm cause and shuts down the pump.
- Deviation  : alerts you to the problem, but pump may continue to run past the set limits until the system's absolute limits are reached.
- Advisory: information only. Pump will continue to operate.



NOTE: On Advanced motors, flow (K codes) and pressure (P codes) can be designated as alarms or deviations. See [Setup Screen 4, page 32](#).

NOTE: In the error codes listed below, an “X” means the code is associated with the display only.

NOTE: In the error codes listed below, a “_” in the code is a placeholder for the number of the pump where the event occurred.

NOTE: The blink code is displayed using the power indicator on the motor. The blink code given below indicates the sequence. For example, blink code 1–2 indicates 1 blink, then 2 blinks; the sequence then repeats.

NOTE: A blink code of 9 is not an error code, but an indicator of which pump is active ( softkey has been pushed, see [Run Screen 1, page 25](#)).

Display Code	Applicable Motor	Blink Code	Alarm or Deviation	Description
None	Basic	6	Alarm	The Mode Select knob is set between Pressure  and Flow  . Set the knob to the mode you want.
None	Basic and Advanced	9	None	A blink code of 9 is not an error code, but an indicator of which pump is active.
A4N_		6	Alarm	The motor current exceeded 13A or the hardware overcurrent tripped at 20A.
CAC_	Advanced	None	Alarm	Display detects a loss of CAN communication. Flashing alarm appears on the display, and the blink code occurs.
CAD_	Advanced	2–3	Alarm	Unit detects a loss of CAN communication. This alarm is only logged. No flashing alarm appears on the display, but the blink code does occur.
CAG_		None	Deviation	The PLC has stopped pinging the register for the solenoid.
C3G_	Advanced	None	Deviation	Display detects a loss of modbus communication when modbus deviation is enabled on Setup Screen 16.
C4G_	Advanced	None	Alarm	Display detects a loss of modbus communication when modbus alarm is enabled on Setup Screen 16.
CBN_	Basic and Advanced	2–4	Deviation	Temporary circuit board communication failure.
CCC_	Advanced	3–7	Alarm	No display was detected at startup.
CCN_	Basic and Advanced	3–6	Alarm	Circuit board communication failure.
END_	Basic and Advanced	5–6	Advisory	A calibration of the encoder and stroke range is in progress.
ENN_	Advanced	None	Advisory	Dual lower system calibration completed successfully.
E5D_	Basic and Advanced	1–7	Deviation	Calibrate coder failure.
E5F_	Advanced	None	Advisory	Dual lower system calibration error. System running too rapidly to perform calibration.
E5N_	Basic and Advanced	2–7	Deviation	Calibrate stroke failed.
E5S_	Advanced	None	Advisory	Dual lower system calibration stopped or interrupted.
E5U_	Advanced	None	Advisory	Dual lower system calibration unsteady. System could not determine optimum setting.

Display Code	Applicable Motor	Blink Code	Alarm or Deviation	Description
EBC_	Advanced	None	Advisory	Run/Stop switch in Stop position (closed).
ELI_	Basic and Advanced	4–5	Deviation	Deviation hot board reset.
ERR0_	Basic and Advanced	2–5	Deviation	Deviation software error.
F1F0		None	Alarm	Fill pump flow not detected. The primary tank level has not increased with the no flow timeout window and the no flow timeout event is set to alarm.
F2F0		None	Deviation	Fill pump flow not detected. The primary tank level has not increased with the no flow timeout window and the no flow timeout event is set to deviation.
K1D_	Advanced	1–2	Alarm	Flow is below minimum limit.
K2D_	Advanced	None	Deviation	Flow is below minimum limit.
K3D_	Advanced	None	Deviation	Flow exceeds maximum target; also indicates pump runaway condition exists.
K4D_	Basic and Advanced	1	Alarm	Flow exceeds maximum target; also indicates pump runaway condition exists.
L1A0		None	Alarm	The flow rate is above the current profile flow limit set on Profile Screen 3.
L1AF	Advanced	None	Alarm	While the system was in off production mode, the current tank level dropped 3% below the value that was recorded when the pump entered off production.
L2A0	Advanced	None	Deviation	The primary tank current level is below the primary tank deviation set point.
L3A0	Advanced	None	Deviation	The primary tank current level is above the primary tank deviation set point.
L4A0		None	Alarm	The primary tank level is above the primary tank level high alarm set point.
L6CA		None	Deviation	Port 8 is enabled and the current draw is less than 4 mA. The BPR is requesting a value greater than 0%. Verify that the device is connected.
L6CB		None	Deviation	Port 9 is enabled and the current draw is less than 4 mA. Verify that the device is connected.
MND_	Advanced	None	Advisory	Maintenance counter is enabled and countdown reached zero (0).
P1CB	Advanced	None	Alarm	Pressure transducer 2 pressure is below the alarm set point.
P1D_	Advanced	None	Deviation	Unbalanced load. Dual Lower system — P1D1 = Motor 1 is requiring less force to hold speed; pump lower may need service. P1D2 = Motor 2 is requiring less force than motor 1 to hold speed.
P9D_	Advanced	None	Deviation	Major unbalanced load — see P1D_ (P9D_ is higher magnitude)
P1I_	Advanced	1–3	Alarm	Pressure is below minimum limit.
P2I_	Advanced	None	Deviation	Pressure is below minimum limit.
P2CB	Advanced	None	Deviation	Pressure transducer 2 pressure is below the deviation set point.
P3CB	Advanced	None	Deviation	Pressure transducer 2 pressure is above the deviation set point.
P3I_	Advanced	None	Deviation	Pressure exceeds maximum target.
P4CB	Advanced	None	Alarm	Pressure transducer 2 pressure is above the alarm set point.
P4I_	Advanced	1–4	Alarm	Pressure exceeds maximum target.

Error Code Troubleshooting

Display Code	Applicable Motor	Blink Code	Alarm or Deviation	Description
P5DX	Advanced	None	Deviation	More than one pump is assigned to a transducer. The assignment for that transducer is automatically cleared under this condition. User must reassign.
P6CA or P6CB	Advanced	None	Deviation	For units without closed loop pressure control: Transducer (A or B) is enabled but not detected.
P6D_	Advanced	1–6	Alarm	For units with closed loop pressure control: Transducer is enabled but not detected.
P7C_	Advanced	None	Deviation	Pressure difference between transducer 1 and transducer 2 is greater than the deviation set point.
P9C_	Advanced	None	Alarm	Pressure difference between transducer 1 and transducer 2 is greater than the alarm set point.
T2D_	Basic and Advanced	3–5	Alarm	Internal thermistor disconnected or motor temperature is below 0° C (32° F).
T3D_	Basic and Advanced	5	Deviation	Motor over temperature. Motor will throttle itself to stay below 85° C (185° F) internally.
T4D_	Basic and Advanced	4–6	Alarm	Motor over temperature. Motor will throttle itself to stay below 85° C (185° F) internally.
V1I_	Basic and Advanced	2	Alarm	Brown out; voltage supplied to motor is too low.
V2I_	Basic and Advanced	None	Deviation	Brown out; voltage supplied to motor is too low.
V1M_	Basic and Advanced	2–6	Alarm	AC power is lost.
V3I_	Basic and Advanced	None	Deviation	Voltage supplied to motor is too high.
V4I_	Basic and Advanced	3	Alarm	Voltage supplied to motor is too high.
V9M_	Basic and Advanced	7	Alarm	Low supply voltage detected at start up.
WCW_	Advanced	None	Alarm	System type mismatch; motor is an E-Flo DC dual lower system and the display configuration does not match. Change the display's system type on the Setup Units screen (screen 15).
WMC_	Basic and Advanced	4–5	Alarm	Internal software error.
WNC_	Basic and Advanced	3–4	Alarm	Software versions do not match.
WNN_	Advanced	None	Alarm	System type mismatch; motor is an E-Flo DC single lower system and the display configuration does not match. Change the display's system type on the Setup Units screen (screen 12 in dual lower mode).
WSC_	Advanced	None	Deviation	Profile is set to 0 pressure or 0 flow.
WSD_	Advanced	1–5	Alarm	Invalid lower size; occurs if the unit is operated before setting up the lower size.
WXD_	Basic and Advanced	4	Alarm	An internal circuit board hardware failure is detected.

Repair

Disassembly



1. Stop the pump at the bottom of its stroke.
2. Follow the [Pressure Relief Procedure, page 17](#).
3. **Models with Sealed Lower:** Remove the 2-piece shield (12) by inserting a screwdriver straight into the slot, and using it as a lever to release the tab. Repeat for all tabs. **Do not** use the screwdriver to pry the shields apart.

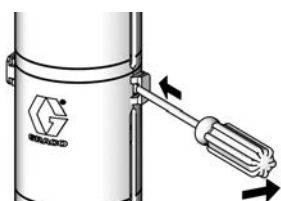

4. Disconnect the inlet and outlet manifolds (3) from the lower and plug the ends to prevent fluid contamination.
5. Loosen the coupling nut (11) and remove the collars (10). Remove the coupling nut from the piston rod (R). Unscrew the locknuts (8) from the tie rods (6). Separate the motor (3) and lower (7).
6. To repair the lower, see the lower manual.
7. There are no user-serviceable parts in the motor. Contact your Graco representative for assistance.

Reassembly

1. If the coupling adapter (16) and tie rods (9) have not been disassembled from the motor (1), skip to step 2.
If the coupling adapter (16) and tie rods (9) have been disassembled from the motor (1), follow these steps:
 - a. Screw the tie rods (9) into the motor (1) and torque to 50-60 ft-lb (68-81 N•m).
 - b. Apply blue thread locker to the coupling adapter (16).
 - c. Screw the coupling adapter (16) into the motor shaft and torque to 90-100 ft-lb (122-135 N•m).
 - d. Continue to step 2.
2. Assemble the coupling nut (17) over the piston rod (R).
3. Orient the lower (4) to the motor (1). Position the lower (4) on the tie rods (9).
4. If you are reusing lock nuts (8) and the nylon of the lock nut is worn or cut, add blue thread locker to the tie rod threads.
5. Screw the lock nuts (8) onto the tie rods (9). Leave the lock nuts (8) loose enough to allow the lower (4) to move so that it can be aligned correctly.

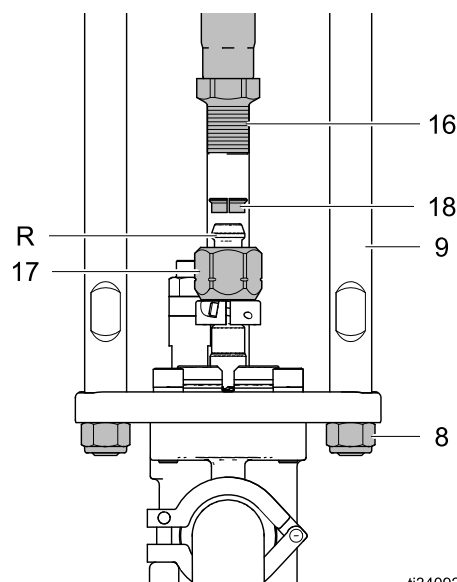

ti34092a

6. Insert the collars (18) into the coupling nut (17). Tighten the coupling nut (17) onto the coupling adapter (16) and torque to 90-100 ft-lb (122-135 N•m) to align the motor shaft with the piston rod (R).
7. Tighten the lock nuts (8) and torque to 50-60 ft-lb (68-81 N•m).

Repair

8. **Models with Sealed Lower:** Install the shields (10) by engaging the bottom lips with the groove in the top plate. Snap the two shields together.

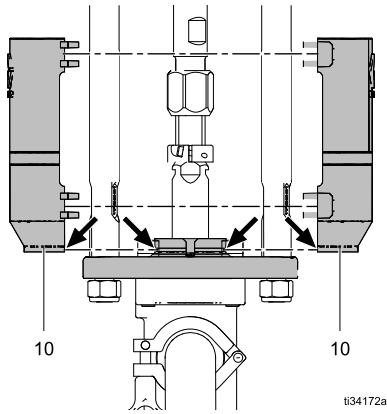

9. Remove the plugs and reconnect the inlet and outlet manifolds (3).
10. Flush and test the pump before reinstalling it in the system. Connect hoses and flush the pump. While it is pressurized, check for smooth operation and leaks. Adjust or repair as necessary before reinstalling in the system. Reconnect the pump ground wire before operating.

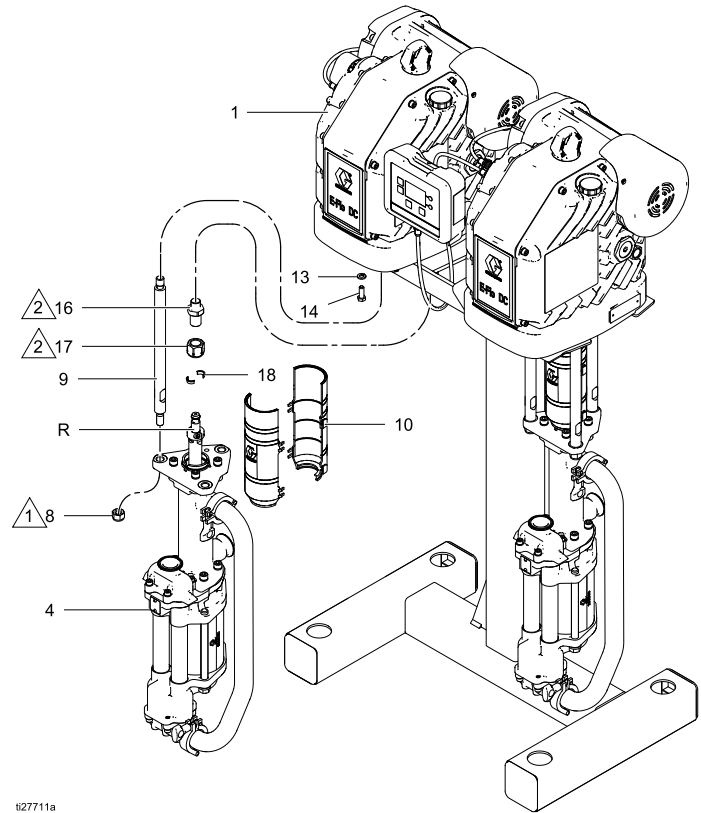

Figure 65 Reassembly with Sealed Bellows Lower

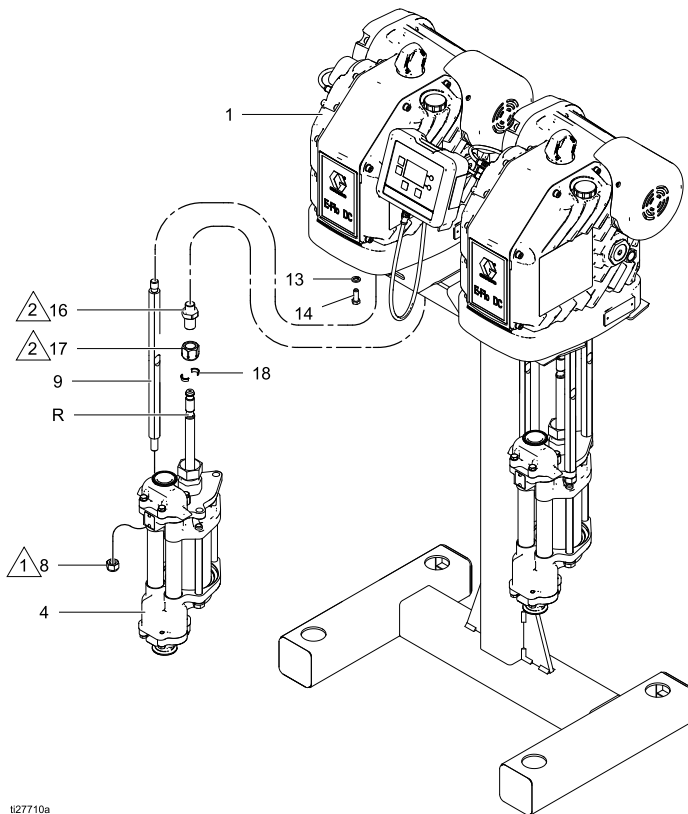

Figure 64 Reassembly with Open Wet Cup Lower

Parts

Pump Assembly

See [Models, page 3](#) , for an explanation of the pump part number.

Models ECxx41, with Sealed 4-Ball Lower

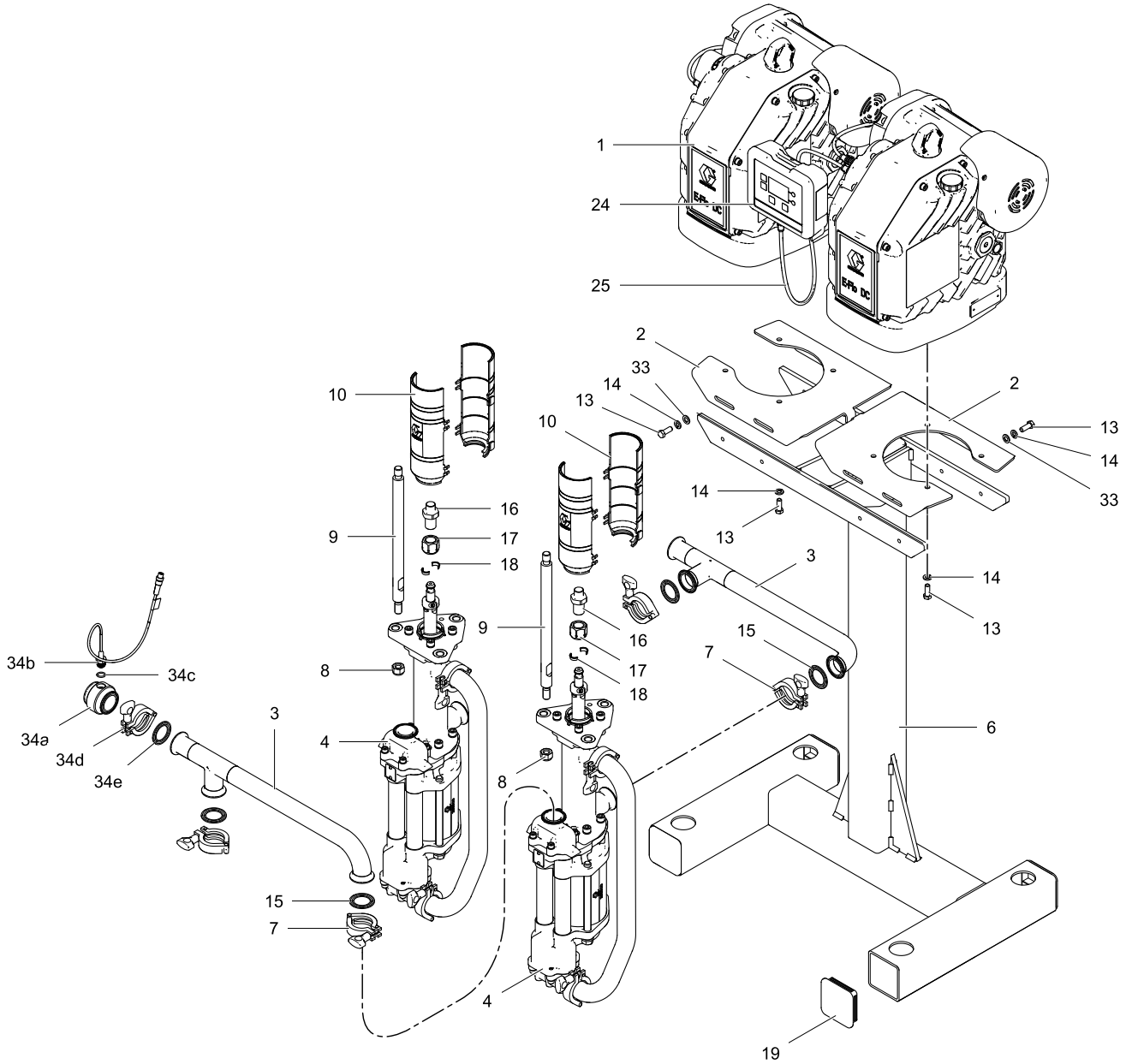

ti28026a

Parts

See [Models, page 3](#) , for an explanation of the pump part number.

Models ECxx61, with Open Wet Cup 4-Ball Lower

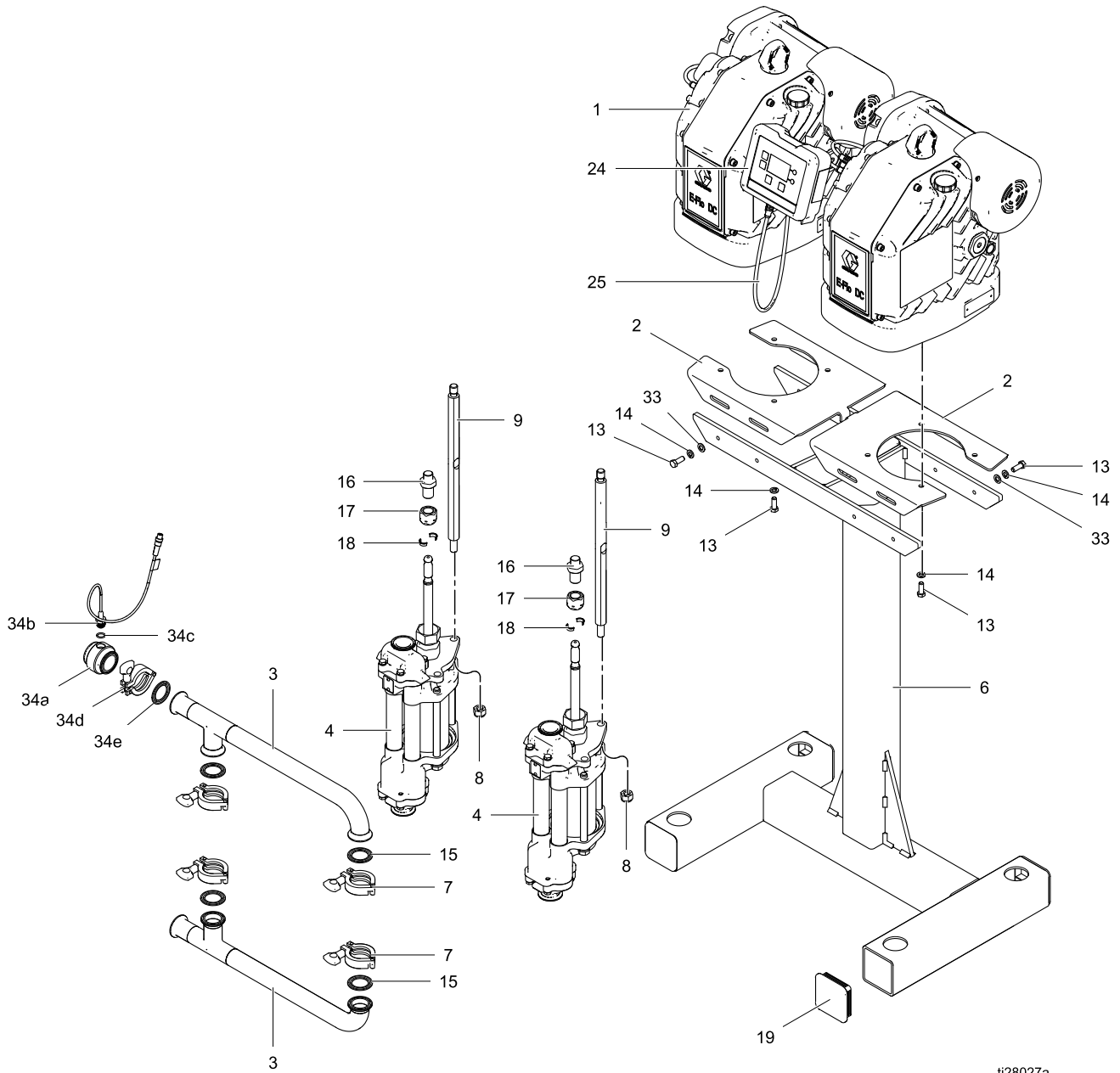

ti28027a

See [Models, page 3](#) , for an explanation of the pump part number.

Models EC8J41, with Sealed 4-Ball Plus Lower

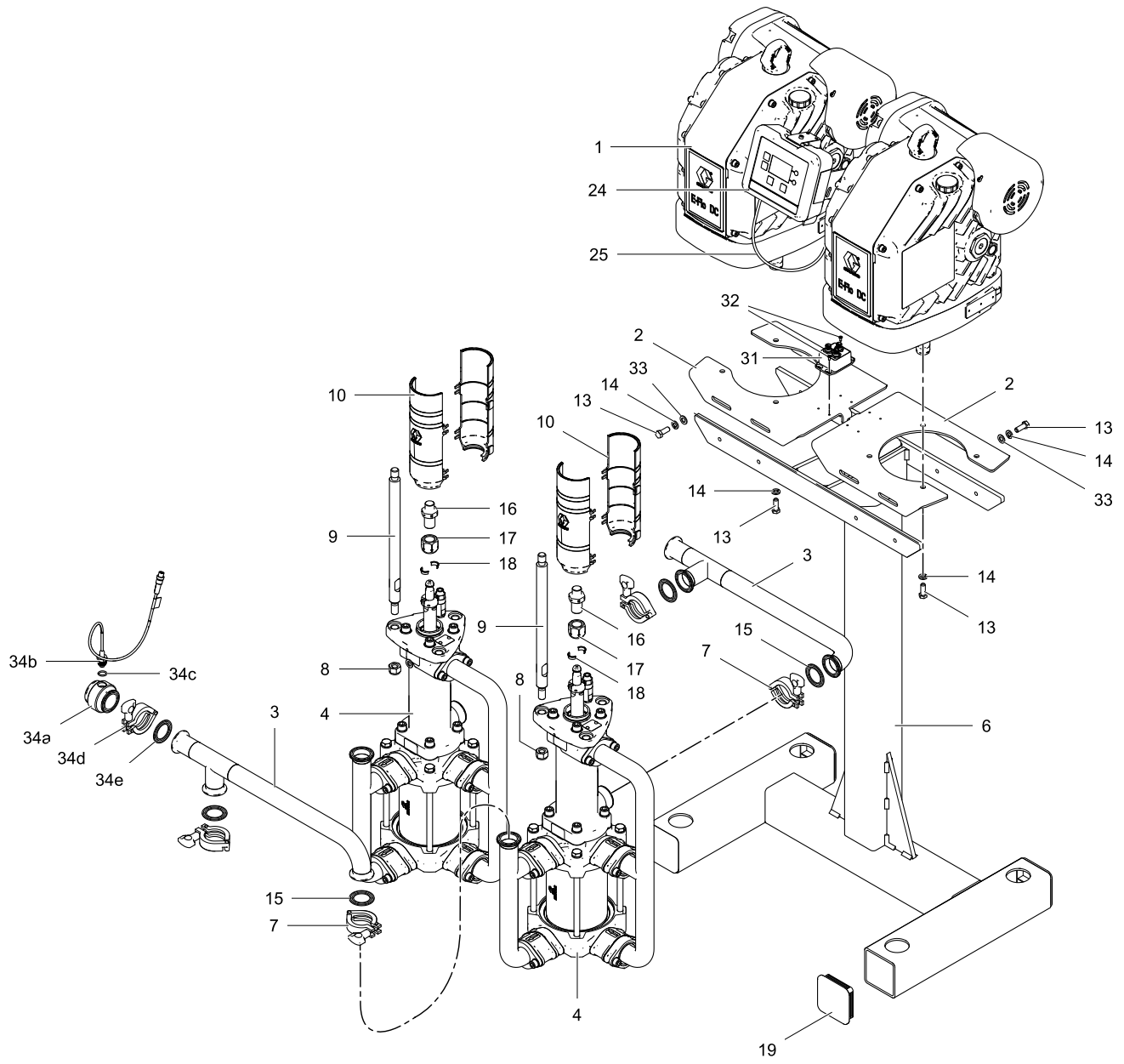

i137449a

Parts

Ref	Part	Description	Qty
1	See Pump Matrix, page 55	MOTOR; see motor manual; includes items 1a and 1b	2
1a▲	16M130	LABEL, warning	2
1b	16W645	OIL, gear, synthetic; ISO 220 silicone-free; 1 quart (0.95 liter); not shown	4
2	16W212	BRACKET, stand	2
3	16W211	MANIFOLD, inlet and outlet	2
4	See Pump Matrix, page 55	PUMP, displacement; see lower manual	2
6	16W214	FRAME, stand	1
7	16G388	CLAMP, sanitary 1.5 in.	4
8	108683	NUT, lock, hex	6
9	15G924 16X771	ROD, tie Lowers with Open Wet Cup Sealed Lowers	6
10	24F251	SHIELD, coupler	2
13	100101	SCREW, cap, hex, hd	16
14	100133	WASHER, lock, 3/8	16
15	120351	GASKET, sanitary	4
16	15H369	ADAPTER, M22x1.5	2
17	17F000	NUT, coupling	2
18	184128	COLLAR, coupling	4
19	16J477	CAP, plug	5
24	24P822	MODULE, control kit	1
25	16P911	CABLE, I.S. CAN, female x female, 3 ft (1 m)	2
	16P912	CABLE, I.S. CAN, female x female, 25 ft (8m) purchase separately	1
33	111203	WASHER, plain	8
34	24X089	PRESSURE SENSOR, kit; includes 34a-e	1
34a	— — —	MANIFOLD, 1.5 in. (38 mm), sanitary transducer	1
34b	— — —	SENSOR, pressure, fluid outlet	1
34c	— — —	O-RING	1
34d	— — —	CLAMP, sanitary, 1.5 in. (38 mm)	1
34e	— — —	GASKET, sanitary	1

▲ Replacement Danger and Warning labels, tags, and cards are available at no cost.

Pump Matrix

Pump Part No.	Pump Series	Motor (Ref 1, Qty. 2)	Lower Pump (Ref 4, Qty. 2)
EC4041	A	EM0026	17K657
EC4061	A	EM0026	17K665
EC4941	A	EM0025	17K657
EC4961	A	EM0025	17K665
EC5041	A	EM0026	17K658
EC5061	A	EM0026	17K666
EC5941	A	EM0025	17K658
EC5961	A	EM0025	17K666
EC6041	A	EM0026	17K659
EC6061	A	EM0026	17K667
EC6941	A	EM0025	17K659
EC6961	A	EM0025	17K667
EC4J41	A	EM1025	17K657
EC5J41	A	EM1025	17K658
EC6J41	A	EM1025	17K659
EC4J61	A	EM1025	17K665
EC5J61	A	EM1025	17K666
EC6J61	A	EM1025	17K667
EC8J41	A	EM1025	17Z695

24P822 Control Module Kit

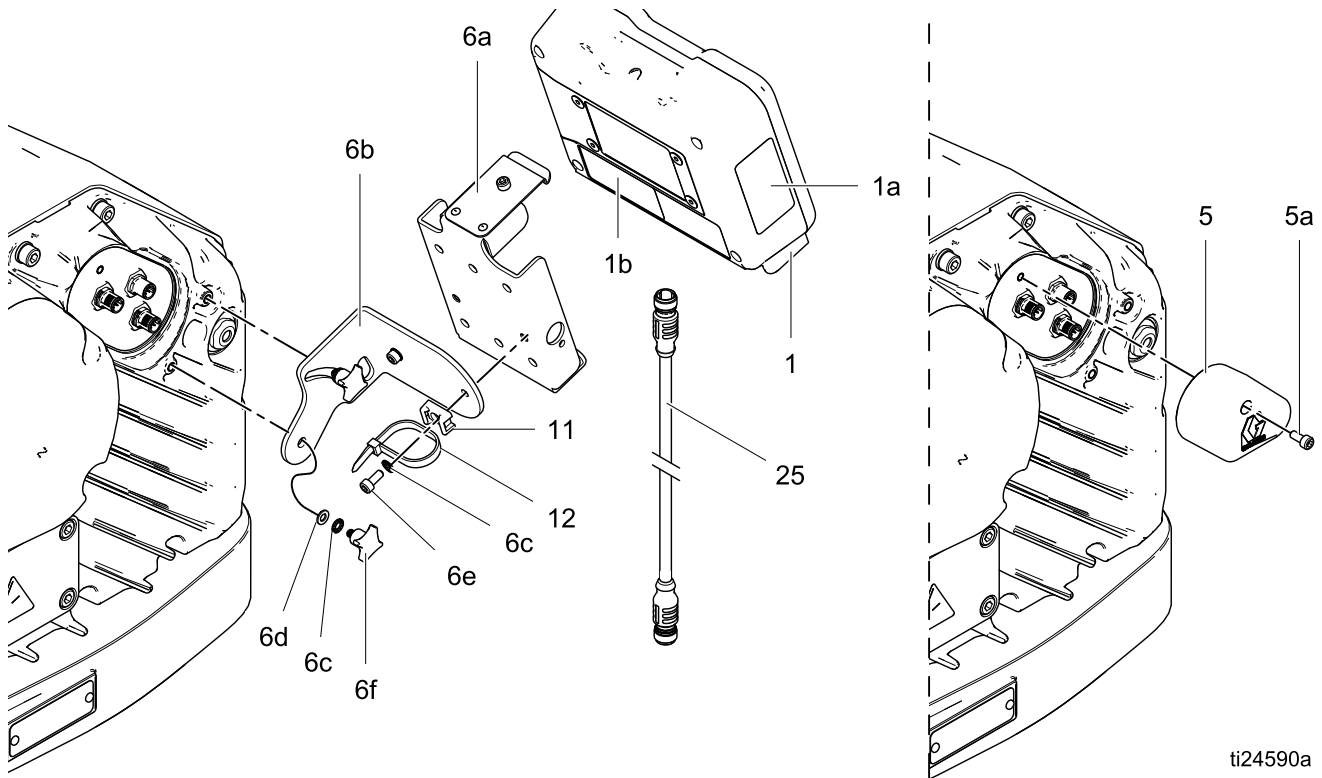

ti24590a

Ref	Part	Description	Qty
1	24P821	DISPLAY KIT, control module; includes item 1a; see manual 332013 for approvals information about the bare ADCM module	1
1a▲	16P265	LABEL, warning, English	1
1b▲	16P265	LABEL, warning, French	1
1c▲	16P265	LABEL, warning, Spanish (shipped loose)	1
5	24N910	CONNECTOR, jumper; includes item 5a	1
5a	— — —	SCREW, cap, socket head; M5 x 40 mm	1
6	24P823	BRACKET KIT, control module; includes items 6a-6f	1

Ref	Part	Description	Qty
6a	— — —	BRACKET, control module	1
6b	— — —	BRACKET, mounting	1
6c	— — —	LOCKWASHER, external tooth; M5	4
6d	— — —	WASHER; M5	2
6e	— — —	SCREW, cap, socket head; M5 x 12 mm	2
6f	— — —	KNOB; M5 x 0.8	2
11	— — —	HOLDER, tie	1
12	— — —	STRAP, tie	1

▲ Replacement Danger and Warning labels, tags, and cards are available at no cost.

Items marked — — — are not available separately.

Cable (25) is shown for reference but is not included in the kit. Order desired length separately. See [Pump Assembly, page 51](#).

Accessories

Back Pressure Regulators

Part	Description
288117	Pneumatic BPR (20 gpm, 300 psi max fluid pressure, 1-1/4 npt)
288311	Pneumatic BPR (20 gpm, 300 psi max fluid pressure, 1-1/2 npt)
288262	Pneumatic BPR (20 gpm, 300 psi max fluid pressure, 2 in. Tri-Clamp)

Control Module

Part	Description
16P912	25 ft (8m) CAN cable
24X089	Pressure Transducer
16V103	Transducer Extension Cable
24V001	Transducer I/P
16U729	Run/Stop Switch
16M172	50 ft (15m) Fiber Optic Cable
16M173	100 ft (30m) Fiber Optic Cable
24R086	Fiber/Serial Converter
15V331	Ethernet IP Gateway Assembly

Dimensions

Pump with Sealed 4-Ball Lower

Pump with Sealed 4-Ball Plus Lower

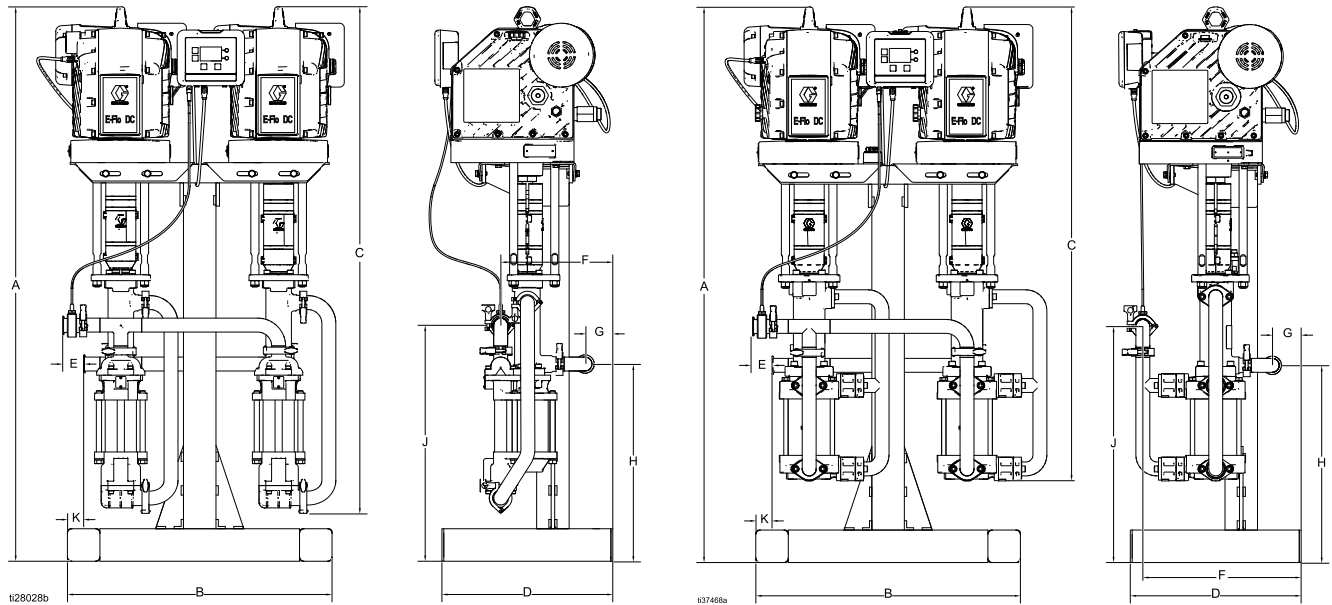

Pumps	A	B	C	D	E	F	G	H	J	K
DC 4-Ball	59.7 in. (151.6 cm)	28.5 in. (72.4 cm)	54.5 in. (138.4 cm)	18.4 in. (46.7 cm)	2.1 in. (5.3 cm)	12.1 in. (30.7 cm)	3.0 in. (7.6 cm)	21.2 in. (53.8 cm)	25.4 in. (64.5 cm)	1.8 in. (3.8 cm)
Sealed 4-Ball Plus			51.0 in. (129.5 cm)			17.1 in. (43.4 cm)	3.1 in. (7.9 cm)			

Pump with Open Wet Cup Lower

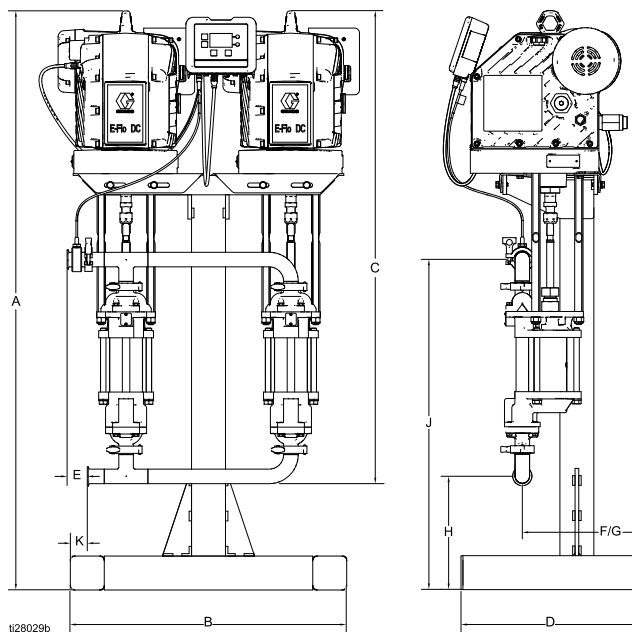

A	B	C	D	E	F	G	H	J	K
59.7 in. (151.6 cm)	28.5 in. (72.4 cm)	45.5 in. (115.6 cm)	18.4 in. (46.7 mm)	2.1 in. (5.3 cm)	12.1 in. (30.7 cm)	12.1 in. (30.7 cm)	11.7 in. (29.7 mm)	34.1 in. (86.6 cm)	1.75 in. (4.4 cm)

Mounting Hole Patterns

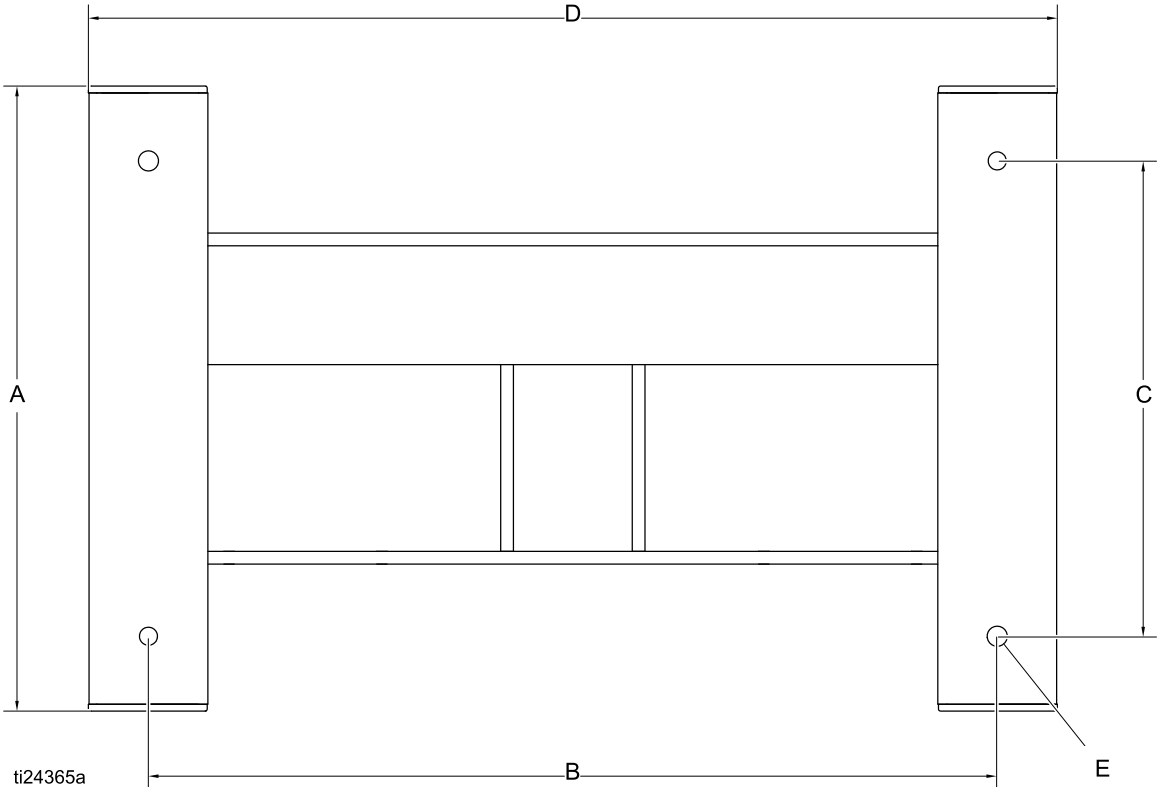

- KEY**
- A** 19.88 in. (505 mm)
 - B** 14.50 in. (368 mm)
 - C** 16.88 in. (429 mm)
 - D** 17.00 in. (432 mm)
 - E** Hole size .59 in. (15 mm)

Appendix A - Modbus Variable Map

To communicate through fiber optics with the E-Flo DC Control Module, reference the appropriate hardware as shown in manual 332356. That manual indicates various options for connecting fiber optic cables from the control module to the non-hazardous area. The following table lists Modbus registers available to a PC or PLC located in the non-hazardous area.

Table 4 shows the registers needed for basic operation, monitoring, and alarm control features. Tables 5 and 6 provide bit definitions as needed for certain registers. Table 7 shows the units and how to convert the register value to a unit value.

Reference the Modbus communication settings selected in [Setup Screen 16, page 41](#).

Table 5 Modbus Registers

Modbus Register	Variable	Register Access	Size	Notes/Units
403225	Fill Pump Solenoid Out	Read/Write	16 Bit	0 = Off, 1 = On
403226	Solenoid Out Keep Alive	Read/Write	16 Bit	Write any value to activate.
403227	Reed Switch Count	Read/Write	16 Bit	Cycle count
403228	Tank Level 1 Full Pressure	Read/Write	16 Bit	Pressure units, see Table 7.
403229	Tank Level 2 Full Pressure	Read/Write	16 Bit	Pressure units, see Table 7.
403230	Actual Tank Level 1%	Read/Write	16 Bit	Pressure units, see Table 7.
403231	Actual Tank Level 2%	Read/Write	16 Bit	Pressure units, see Table 7.
403232	Configurable IO Type	Read/Write	16 Bit	0 = Reed switch input, 1 = Drum cover switch input
403233	Agitator Half Status	Read/Write	16 Bit	0 = Drum cover down, 1 = Drum cover up, 2 = Accessory solenoid out
403234	Accessory Solenoid Out	Read/Write	16 Bit	0 = Off, 1 = On

404100	Pump Status Bits	Read Only	16 Bit	See Table 6 for bit definitions.
404101	Actual Pump Speed	Read Only	16 Bit	Speed units, see Table 7.
404102	Actual Pump Flow Rate	Read Only	16 Bit	Flow units, see Table 7.
404103	Actual Pump Pressure	Read Only	16 Bit	Percent pressure, see Table 7.
404104	Transducer 1 Pressure	Read Only	16 Bit	Pressure units, see Table 7.
404105	Transducer 2 Pressure	Read Only	16 Bit	Pressure units, see Table 7.
404106	Batch Total High Word	Read Only	16 Bit	Volume units, see Table 7.
404107	Batch Total Low Word	Read Only	16 Bit	Volume units, see Table 7.
404108	Grand Total High Word	Read Only	16 Bit	Pump cycles, see Table 7.
404109	Grand Total Low Word	Read Only	16 Bit	Pump cycles, see Table 7.
404110	Maintenance Total High Word	Read Only	16 Bit	Pump cycles, see Table 7.
404111	Maintenance Total Low Word	Read Only	16 Bit	Pump cycles, see Table 7.
404112	Pump Events 1 — High Word	Read Only	16 Bit	See Table 5 for bit definitions.
404113	Pump Events 1 — Low Word	Read Only	16 Bit	See Table 5 for bit definitions.
404114	Display Events — High Word	Read Only	16 Bit	See Table 5 for bit definitions.
404115	Display Events — Low Word	Read Only	16 Bit	See Table 5 for bit definitions.
404116	Pump Events 2 — High Word	Read Only	16 Bit	See Table 5 for bit definitions.
404117	Pump Events 2 — Low Word	Read Only	16 Bit	See Table 5 for bit definitions.
404118	System Type	Read Only	16 Bit	0 = Single lower, 1 = Dual lower

Modbus Register	Variable	Register Access	Size	Notes/Units
404119	Run/Stop Switch State	Read Only	16 Bit	0 = Switch closed (Stop state), 1 = Switch open (Run state)

Extended Modbus Variables				
The registers shown in this section are intended for advanced integration solutions, where the user desires full control of the system by the PLC. For optimal communication latency, it is recommended that only the registers which will be monitored and changed on a regular basis be mapped and the remaining parameters be configured with the display.				
404150	Pressure Minimum	Read Only	16 Bit	Pressure units, see Table 7.
404151	Pressure Target	Read Only	16 Bit	Pressure units, see Table 7.
404152	Pressure Maximum	Read Only	16 Bit	Pressure units, see Table 7.
404153	Flow Minimum	Read Only	16 Bit	Flow units, see Table 7.
404154	Flow Target	Read Only	16 Bit	Flow units, see Table 7.
404155	Flow Maximum	Read Only	16 Bit	Flow units, see Table 7.
404156	Mode	Read Only	16 Bit	0 = pressure, 1 = flow
404157	BPR % Open	Read Only	16 Bit	Value will be 0-100 (Approximately 1-100 psi, see manual 332142 for information on BPR control kit)
404158	Pressure/Force Min Alarm Type	Read Only	16 Bit	0 = limit, 1 = deviation, 2 = alarm
404159	Pressure/Force Max Alarm Type	Read Only	16 Bit	0 = limit, 1 = deviation, 2 = alarm
404160	Flow Min Alarm Type	Read Only	16 Bit	0 = limit, 1 = deviation, 2 = alarm
404161	Flow Max Alarm Type	Read Only	16 Bit	0 = limit, 1 = deviation, 2 = alarm

Appendix A - Modbus Variable Map

Modbus Register	Variable	Register Access	Size	Notes/Units
Integration Setup Block This section contains system-level control variables that may need to be monitored or controlled on occasion (infrequently).				
404200	Local/Remote Control	Read / Write	16 Bit	0 = local, 1 = remote/PLC
404201	Active Profile Number	Read / Write	16 Bit	0 = stopped, 1, 2, 3, 4
404202	Pump Control Bitfield	Read / Write	16 Bit	See Table 6 for bit definitions.
404203	Maintenance Interval High Word	Read / Write	16 Bit	Pump cycles, see Table 7.
404204	Maintenance Interval Low Word	Read / Write	16 Bit	Pump cycles, see Table 7.
404205	Transducer 1 type	Read / Write	16 Bit	0 = None, 1 = 500 psi (3.44 mPa, 34.47 bar), 2 = 5000 psi (34.47 mPa, 344.74 bar), 3 = 5 psi (34.5 kPa, 0.345 bar) Tank level sensor.
404206	Transducer 2 type	Read / Write	16 Bit	
404207	Closed Loop Enable Transducer 1	Read / Write	16 Bit	0 = Not Enabled, 1 = Enabled (Note: only 1 transducer can be enabled for closed loop control)
404208	Closed Loop Enable Transducer 2	Read / Write	16 Bit	
404209	Reserved	Read / Write	16 Bit	N/A
404210	Pump Lower Type	Read / Write	16 Bit	0 = Invalid/Not configured, 1 = 145cc, 2 = 180cc, 3 = 220cc, 4 = 290cc, 5 = 750cc, 6 = 1000cc, 7 = 1500cc, 8 = 2000cc, 9 = 2500cc
404211	Pump Lower Size	Read / Write	16 Bit	Actual lower size in cc
404212	Agitator 4-20mA Output	Read / Write	16 Bit	0-100 = 4-20mA
404213	Agitator 4-20mA Output Enable	Read / Write	16 Bit	0 = Disable, 1 = Enable
404214	BPR % Open Stop Profile	Read / Write	16 Bit	Setting for when the stop profile is active to hold fluid line pressure when the pump is stopped. (See 405107 below)
404215	Reserved for E-Flo DCX2			
404216	Reserved for E-Flo DCX2			
404250	Password Enable	Read / Write	16 Bit	0 = Disable, 1 = Enable
404251	Profile Lock	Read / Write	16 Bit	0 = Unlocked, 1 = Locked
403102	Display seconds	Read Only	16 Bit	Use as heartbeat.

Modbus Register	Variable	Register Access	Size	Notes/Units
Intelligent Paint Kitchen Registers Run				
406100	Secs Counter	Read Only		0 - 60
406101	Pump Status Bits	Read Only		bit 0 = Pump trying to move bit 1 = Pump actually moving bit 2 = Active Alarm bit 3 = Active Deviation bit 4 = Active Advisory bit 5 = Setup Modified (Registers 6141-6159) bit 6 = Reserved/unused bit 7 = Run Status bit 8 = Profile 1 Modified bit 9 = Profile 2 Modified bit 10 = Profile 3 Modified bit 11 = Profile 4 Modified bit 12 = Tank Events
406102	Actual Pump Speed	Read Only		0 - 65535
406103	Actual Pump Flow Rate	Read Only		
406104	Estimated Pump Force or Pressure	Read Only		
406105	Transducer 1 Pressure	Read Only		0 - 65535
406106	Transducer 2 Pressure	Read Only		0 - 65535
406107	ADCM Input Status Bits	Read Only		bit 0 / bit 1: 0 = Stop 1 = Run 2 = Toggle bit 2 = Agitator Halt Status 0 = Not Active 1 = Active
406108	ADCM Output Bits	Read / Write		0 = Fill Pump 1 = Aux Output
406109	Active Profile Number	Read / Write		0 - 4
406110	Agitator VFD/Analog Output #2 % (4 - 20 ma)	Read / Write		0 - 100
406111	VFD Enable Status	Read / Write		0 = Off 1 = On
406112	Actual Tank Level #1 Pct	Read / Write		0 - 100
406113	Agitator Profile Enable	Read / Write		0 = Disabled 1 = Enabled
406114	Batch Total High Word	Read Only		0 - 65535
406115	Batch Total Low Word	Read Only		0 - 65535
406116	Grand Total High Word Pump 1	Read Only		0 - 65535
406117	Grand Total Low Word Pump 1	Read Only		0 - 65535
406118	Grand Total High Word Pump 2 (x2)	Read Only		0 - 65535
406119	Grand Total Low Word Pump 2 (x2)	Read Only		0 - 65535
406120	Tank Level Freeze Percent	Read Only		0 - 100

Appendix A - Modbus Variable Map

Modbus Register	Variable	Register Access	Size	Notes/Units
Intelligent Paint Kitchen Registers Setup				
406129	Pump 1 Alarms High Word	Read Only		
406130	Pump 1 Alarms Low Word	Read Only		
406131	Display 1 Alarms High Word	Read Only		
406132	Display 1 Alarms Low Word	Read Only		
406133	Pump 1 Alarms 2 High Word	Read Only		
406134	Pump 1 Alarms 2 Low Word	Read Only		
406135	Pump 2 Alarms High Word	Read Only		
406136	Pump 2 Alarms Low Word	Read Only		
406137	Pump 2 Alarms 2 High Word	Read Only		
406138	Pump 2 Alarms 2 Low Word	Read Only		
406139	Pump Control Bitfield	Read / Write		bit 0 = Clear Alarm bit 1 = Reset Batch bit 2 = Reset Maint Counter 1 bit 3 = Reset Maint Counter 2 bit 4 = Reset Maint Agitator
406140	Configuration	Read / Write		bit 0: 0 = Local 1 = Remote bit 14: Run/Stop Switch 0 = Disable 1 = Enable bit 15: Remote Start 0 = Enable 1 = Disable
406141	System Type	Read / Write		0 = Single Lower 1 = Dual Lower
406142	Pressure Units	Read / Write		0 = Psi 1 = bar 2 = Mpa
406143	Volume Units	Read / Write		0 = Liters 1 = Gallons
406144	Flow Units	Read / Write		0 = Liter/min 1 = Gallons/min 2 = cc/min 3 = oz/min 4 = Cycles / min
406145	Agitator Speed Units	Read / Write		0 = Percent 1 = Hertz 2 = RPM
406146	Stop Profile BPR % Setting	Read / Write		0-100
406147	Primary Tank Level High Alarm	Read / Write		0-100
406148	Primary Tank Fill Target	Read / Write		0-100
406149	Primary Tank Fill Level	Read / Write		0-100
406150	Primary Tank Level Low Alarm	Read / Write		0-100
406151	Primary Tank Freeze Level Alarm	Read / Write		0-65535
406152	TBD	Read / Write		0-65535

Modbus Register	Variable	Register Access	Size	Notes/Units
406153	TBD	Read / Write		0-65535
406154	TBD	Read / Write		0-65535
406155	Closed Loop Enable Transducer	Read / Write		bit 0 =Enable/Disable Trans 1 bit 1 = Enable/Disable Trans 2
406156	Pump Lower Size	Read		0-65535 cc
406157	Auxiliary IO Function	Read / Write		0 = Reed Switch Count (Aux In) 1 = Agitator Halt (Aux In) 2 = High Level Primary (Aux Out) 3 = Low Level Primary (Aux Out) 4 = Low Level Secondary (Aux Out) 5 = PLC (Aux Out)

Appendix A - Modbus Variable Map

Modbus Register	Variable	Register Access	Size	Notes/Units
Profile Setup Blocks Each profile block is a group of 12 registers. The profile (1–4) is the 4th digit (x) in the register number and corresponds with the actual user profile being defined. For example, register 405x00 will represent 405100, 405200, 405300, and 405400.				
405x00	Pressure/Force Minimum	Read / Write	16 Bit	Pressure units, see table 7.
405x01	Pressure/Force Target	Read / Write	16 Bit	Pressure units, see table 7.
405x02	Pressure/Force Maximum	Read / Write	16 Bit	Pressure units, see table 7.
405x03	Flow Minimum	Read / Write	16 Bit	Flow units, see table 7.
405x04	Flow Target	Read / Write	16 Bit	Flow units, see table 7.
405x05	Flow Maximum	Read / Write	16 Bit	Flow units, see table 7.
405x06	Mode Select	Read / Write	16 Bit	0 = pressure, 1 = flow
405x07	BPR % Open	Read / Write	16 Bit	Value will be 0-100 (Approximately 1-100 psi, see manual 332142 for information on BPR control kit)
405x08	Pressure/Force Min Alarm Type	Read / Write	16 Bit	0 = limit, 1 = deviation, 2 = alarm
405x09	Pressure/Force Max Alarm Type	Read / Write	16 Bit	0 = limit, 1 = deviation, 2 = alarm
405x10	Flow Min Alarm Type	Read / Write	16 Bit	0 = limit, 1 = deviation, 2 = alarm
405x11	Flow Max Alarm Type	Read / Write	16 Bit	0 = limit, 1 = deviation, 2 = alarm

NOTE: See [Error Code Troubleshooting, page 46](#), for a description of each alarm.

Table 6 Alarm Bits

404112 - Pump Events 1 — High Word			
Bit	Event Type	Event Code	Event Name
0	Deviation	T3D_	Over Temperature Deviation
1	—	—	Reserved
2	Alarm	P6D_	Pressure Transducer Missing
3	Deviation	ERR_	Software Error
4	Advisory	MND_	Maintenance Count
5	Alarm	V1M_	AC Power Loss
6	Deviation	T2D_	Low Temperature
7	Alarm	WNC_	Version Mismatch
8	Alarm	CCN_	IPC Communication
9	Alarm	WMC_	Internal Software Error
10	—	—	Reserved
11	Deviation	WSC_	Zero Setting on Active Profile
12	Deviation	END_	Encoder/Stroke range calibration in progress
13	Alarm	A4N_	Over Current
14	Alarm	T4D_	Over Temperature Alarm
15	Alarm	WCW_	Dual Lower System with Display in Single Lower Mode
404113 - Pump Events 1 — Low Word			
Bit	Event Type	Event Code	Event Name
0	Alarm	K1D_	Minimum Speed
1	Deviation	K2D_	Minimum Speed
2	Alarm	K4D_	Maximum Speed
3	Deviation	K3D_	Maximum Speed
4	Alarm	P1I_	Minimum Pressure
5	Deviation	P2I_	Minimum Pressure
6	Alarm	P4I_	Maximum Pressure
7	Deviation	P3I_	Maximum Pressure
8	Alarm	V1I_	Under Voltage
9	Alarm	V4I_	Over Voltage
10	Alarm	V1I_	High Pressure 120V
11	Alarm	CAD_	CAN Communication Pump
12	Deviation	CBN_	Inter Processor Communication Error
13	Alarm	WXD_	Board Hardware
14	Alarm	WSD_	Invalid Lower Size
15	—	—	Reserved
404116 - Pump Events 2 — High Word			
Bit	Event Type	Event Code	Event Name
0	—	—	Reserved

Appendix A - Modbus Variable Map

1	—	—	Reserved
2	—	—	Reserved
3	Deviation	CAD_	CAN Communication Error Pump
4	Deviation	E5D_	Encoder Calibration Failed
5	Deviation	E5N_	Stroke Calibration Failed
6	Advisory	ENDC	Encoder/Stroke Range Calibration In Progress
7	Alarm	CCC_	Pump Could Not Find Display During Startup
8	Deviation	ELI_	Unexpected Hot Board Reset
9	Alarm	A5N_	Over Current
10	Advisory	ELD_	Reserved
11	—	—	Reserved
12	—	—	Reserved
13	—	—	Reserved
14	—	—	Reserved
15	—	—	Reserved
404117 - Pump Events 2 — Low Word			
Bit	Event Type	Event Code	Event Name
0	Advisory	E5F_	X2 Calibration Error, Too Fast
1	Advisory	ENN_	X2 Calibration Completed
2	Alarm	WNN_	Single Lower System with Display in Dual Lower Mode
3	—	—	Reserved
4	Advisory	E5S_	Dual Lower System Calibration Stopped or Interrupted
5	Advisory	E5U_	Dual Lower System Calibration Unsteady
6	Alarm	V9M_	Lower Supply Voltage Detected at Startup
7	—	—	Reserved
8	—	—	Reserved
9	—	—	Reserved
10	—	—	Reserved
11	—	—	Reserved
12	—	—	Reserved
13	—	—	Reserved
14	—	—	Reserved
15	—	—	Reserved

404114 - Display Events — High Word			
Bit	Event Type	Event Code	Event Name
0	Deviation	P6CX	Pressure Transducer Error
1	Alarm	L1AF	Primary Tank Freeze Alarm
2	Deviation	P3CB	Pressure Transducer 2 High Deviation
3	Alarm	P4CB	Pressure Transducer 2 High Alarm
4	Deviation	P2CB	Pressure Transducer 2 Low Deviation
5	Alarm	P1CB	Pressure Transducer 2 Low Alarm
6	Deviation	P7CX	Pressure Delta Deviation
7	Alarm	P9CX	Pressure Delta Alarm
Others	—	—	Reserved
404115 - Display Events — Low Word			
Bit	Event Type	Event Code	Event Name
0	Alarm	P5D_	Transducer Assignment Conflict
1	Deviation	P1D_	Unbalanced Load
2	Deviation	CAG_	Solenoid Keep Alive Signal Not Detected
3	Deviation	C3GX	Modbus Communications Lost
4	Alarm	C4GX	Modbus Communications Lost
5	Deviation	P9D_	Major Unbalanced Load (x2 System)
6	Advisory	EBCX	Run/Stop Switch Closed
7	Deviation	L3AO	Primary Tank High Deviation
8	Alarm	L4AO	Primary Tank High Alarm
9	Deviation	L2AO	Primary Tank Low Deviation
10	Alarm	L1AO	Primary Tank Low Alarm
11	Deviation	F2FO	No Flow Fill Pump Deviation
12	Alarm	F1FO	No Flow Fill Pump Alarm
13	Deviation	L6CA	Port 8 4 to 20 mA open circuit
14	Alarm	L6CB	Port 9 4 to 20 mA open circuit
15	Alarm	CACX	Display CAN Communication Alarm

Table 7 Pump Status and Control Bits

404100 - Pump Status Bits	
Bit	Meaning
0	Reads 1 if the pump is trying to move
1	Reads 1 if the pump is actually moving
2	Reads 1 if there are any active alarms
3	Reads 1 if there are any active deviations
4	Reads 1 if there are any active advisories
5	Setup changed
6	Reserved
7	Run/Stop switch closed
8	Profile 1 changed
9	Profile 2 changed
10	Profile 3 changed
11	Profile 4 changed
12	Others reserved for future tank events
404202 - Pump Control Bits	
Bit	Meaning
0	Reads 0 for an active alarm or deviation. Reset to 1 to clear.
1	Set to 1 to reset the batch total
2	Set to 1 to reset the maintenance counter
others	Reserved for future use - only write 0

Table 8 Units

Unit Type	Selectable Units	Units Register	Converting registers to unit values	Register value for 1 unit
Pressure	Percent	n/a	Pressure = Register	1 = 1% Pressure
Pressure	psi	403208 = 0	Pressure = Register	1 = 1 psi
	Bar	403208 = 1	Pressure = Register/10	10 = 1.0 Bar
	MPa	403208 = 2	Pressure = Register/100	100 = 1.00 Mpa
Speed	Cycles/min	n/a	Speed = Register/10	10 = 1.0 cycle/min
Flow	Liters/min	403210 = 0	Flow = Register/10	10 = 1.0 L/min
	Gallons/min	403210 = 1	Flow = Register/10	10 = 1.0 Gal/min
	cc/min	403210 = 2	Flow = Register	1 = 1 cc/min
	oz/min	403210 = 3	Flow = Register	1 = 1 oz/min
	Cycles/min	403210 = 4	Flow = Register/10	10 = 1.0 cycle/min
Volume †	Liters	403209 = 0	Volume = 1000*High + Low/10	0 (High) / 10 (Low) = 1.0 L
	Gallons	403209 = 1	Volume = 1000*High + Low/10	0 (High) / 10 (Low) = 1.0 Gal
Cycles	Pump Cycles	n/a	Cycles = 10000*High + Low	0 (High) / 1 (Low) = 1 cycle

† Example of converting volume register reading to units: If the reading for register 404106 (volume high word) is 12, and the reading for register 404107 (volume low word) is 34, the volume is 12003.4 liters. $12 * 1000 + 34/10 = 12003.4$.

†† Example of converting cycles register reading to units: If the reading for register 404108 (cycles high word) is 75, and the reading for register 404109 (cycles low word) is 8000, the volume is 758,000 cycles. $75 * 10000 + 8000 = 758000$.



Appendix B - Pump Control from a PLC

This guide shows how to use the information in Appendix A to control a pump remotely from a PLC. The steps progress from basic pump control to more advanced monitoring and alarm control features.

It is important that you first follow all directions in the Setup Screens to configure your system properly. Test that the pump operates correctly when controlled from the Display. Make sure the display, fiber optics, communication gateway, and PLC are connected properly. Refer to Communication Kit manual. Use [Setup Screen 11, page 38](#) to enable remote control and set your modbus preferences.

1. **Enable PLC control:** Set register 404200 to 1.
2. **Run a pump:** Set register 404201. Enter 0 for stopped, 1 to 4 for the desired profile.
3. **View pump profile:** Read register 404201. This register updates automatically to reflect the actual pump status. If the profile is changed from the display, this register changes as well. If the pump stops due to an alarm, this register will read 0.
4. **View pump status:** Read register 404100 to see the status of the pump. See Appendix A, Table 7, for a description of each bit.
 - Example 1: Register 404100, bit 1, reads 1 if the pump is currently moving.
 - Example 2: Register 404100, bit 2 reads 1 if the pump has an active alarm.
5. **Monitor alarms and deviations:** Read register 404112 to 404115. Each bit in these registers corresponds to an alarm or deviation. See Appendix A, Table 5.
 - Example 1: Pressure falls below the minimum setting entered on Setup Screen 2. It will show on bit 4 of register 404113 if minimum pressure is set to Alarm, and on bit 5 of register 404113 if minimum pressure is set to Deviation.
 - Example 2: The system is set up for a pressure transducer on Setup Screen 8, but no transducer is detected. It will show on bit 1 of register 404114.
6. **Monitor pump cycle rate, flow rate, and pressure:** Read registers 404101 to 404105. Note that pressure is available only if a pressure transducer is connected to the display. Register 404104 shows the pressure on transducer 1. Register 404105 shows the pressure on transducer 2. See Appendix A, Table 8 for units for these registers.
 - Example 1: If register 404101 reads 75, the pump speed is 7.5 cycles/minute.
 - Example 2: If register 404103 reads 67, the pump is operating at 67 percent pressure.
7. **Reset active alarms and deviations:** Clear the condition that caused the alarm. Set register 404202, bit 0, to 1 to clear the alarm. The pump will be in profile 0 due to the alarm. Set 404201 to the desired profile to run the pump again.

Appendix C - Control Module Programming

				
<p>To help prevent fire and explosion, do not connect, download, or remove the token unless the unit is removed from the hazardous (explosive atmosphere) location.</p>				

- **All data in the module may be reset to factory default settings.** Record all settings and user preferences before the upgrade, for ease of restoring them following the upgrade.
- The latest software version for each system can be found at www.graco.com.

Software Upgrade Instructions

NOTE: If the software on the token is the same version that is already programmed on the module, nothing will happen (including flashing red light). No harm can be done by attempting to program the module multiple times.

1. Remove power from the Graco Control Module by turning off system power.
NOTE: Alternately, software update can be done without removing power by using the system reset button on Setup Screen 16 (date and time) to initiate the update after token insertion.
2. Remove access cover (C).

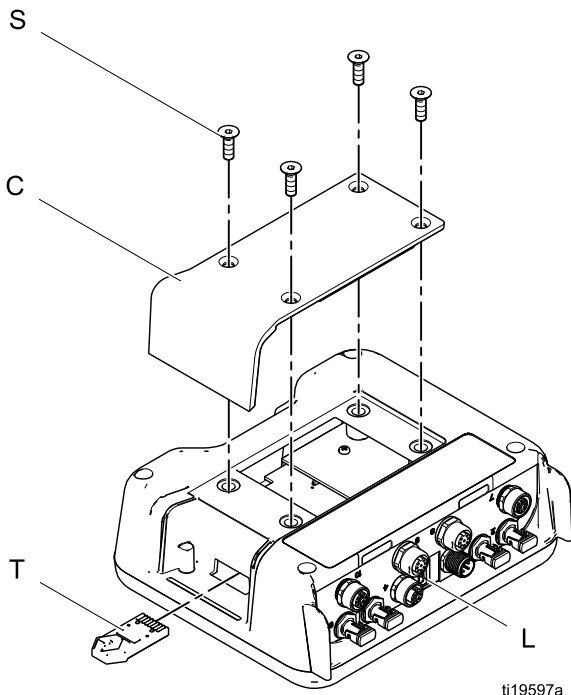

3. Insert and press the token (T) firmly into the slot.
NOTE: Token has no preferred orientation.
4. Supply electrical power to the Graco Control Module.
5. The red indicator light (L) will flash while the software is being loaded on the display. When the software is completely loaded, the red light will turn off.

NOTICE
<p>To prevent corrupting the software, do not remove the token, turn off the system power, or disconnect any modules until the status screen indicates that updates are complete.</p>

6. The following screen will be shown when the display turns on.



Communications with motors established.

7. Wait for update to complete.
NOTE: The approximate time until completion is shown along bottom of progress bar.

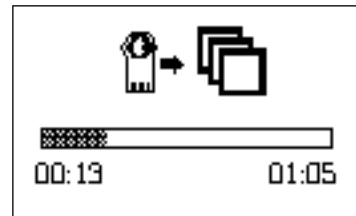

Appendix C - Control Module Programming

8. Updates are complete. Icon indicates update success or failure. Unless the update was unsuccessful, remove the token (T) from the slot.

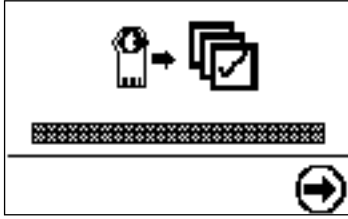

Icon	Description
	Update successful
	Update unsuccessful
	Update complete; no change necessary

9. Press  to continue. If the token is still inserted, the remote loading procedure will begin anew. Return to step 5 for step progression if the update restarts.
10. Remove power from the Graco Control Module by turning off system power.
11. If the token is still inserted, remove from the slot.
12. Reinstall the access cover and secure with screws (S).

Performance Charts

To find the fluid pressure (psi/bar/MPa) at a specific fluid flow (gpm/lpm) and percentage of maximum force:

1. Locate the desired fluid flow in the scale at the bottom of the chart.
2. Follow the vertical line up to the intersection with the selected percentage of maximum force (see the **Key** below).
3. Follow left to the vertical scale to read the fluid outlet pressure.

Key to Performance Charts

NOTE: The charts show the motor operating at 100%, 70%, and 40% of maximum force. These values are approximately equivalent to an air motor operating at 100, 70, and 40 psi.

100% of maximum force	—————
70% of maximum force	- - - - -
40% of maximum force	- - - - -

Models EC4xxx 2000cc (2x 1000 cc lower, 2 HP motor, 2800 lb maximum force)

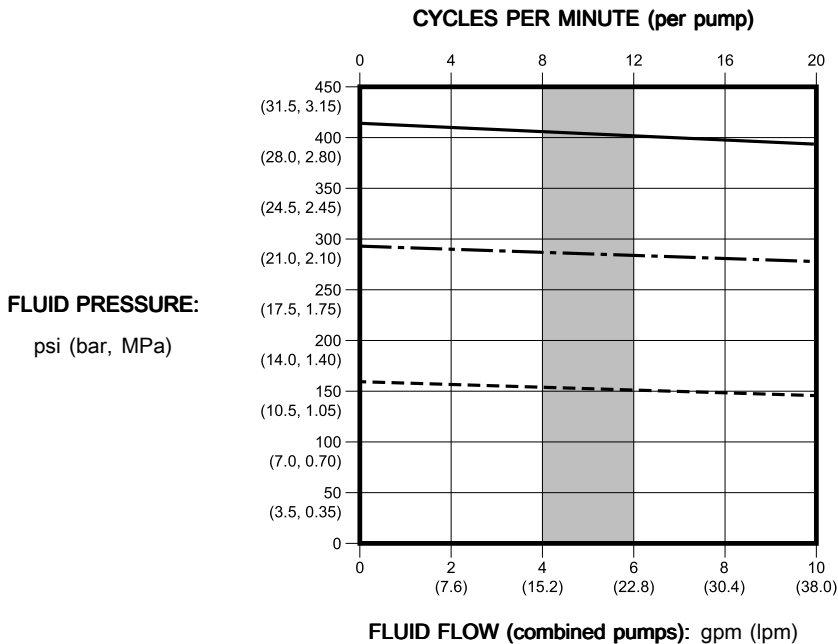

NOTE: The shaded area within the table shows the recommended range for continuous-duty circulation.

Models EC5xxx and EC22xx 3000 cc (2x 1500 cc lower, 2 HP motor, 2800 lb maximum force)

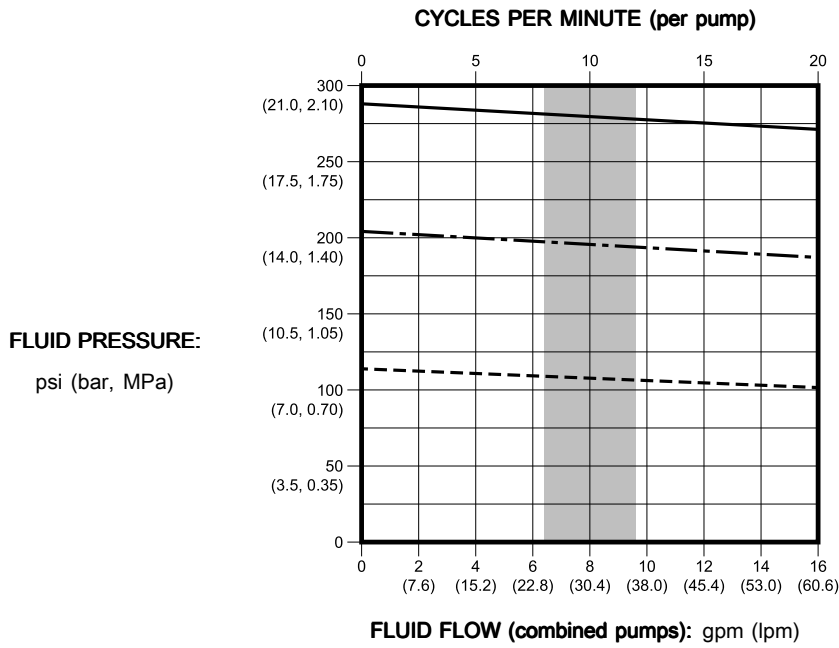

NOTE: The shaded area within the table shows the recommended range for continuous-duty circulation.

Models EC6xxx 4000 cc (2x 2000 cc lower, 2 HP motor, 2800 lb maximum force)

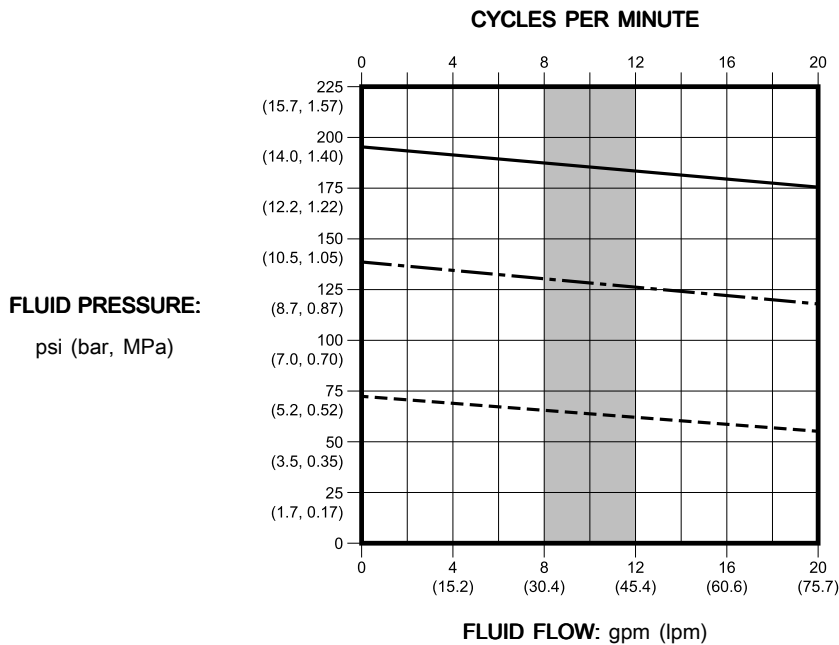

NOTE: The shaded area within the table shows the recommended range for continuous-duty circulation.

Performance Charts

Models EC8J41 5000cc (2x 2500 cc lower, 2 HP motor, 3500 lb max force)

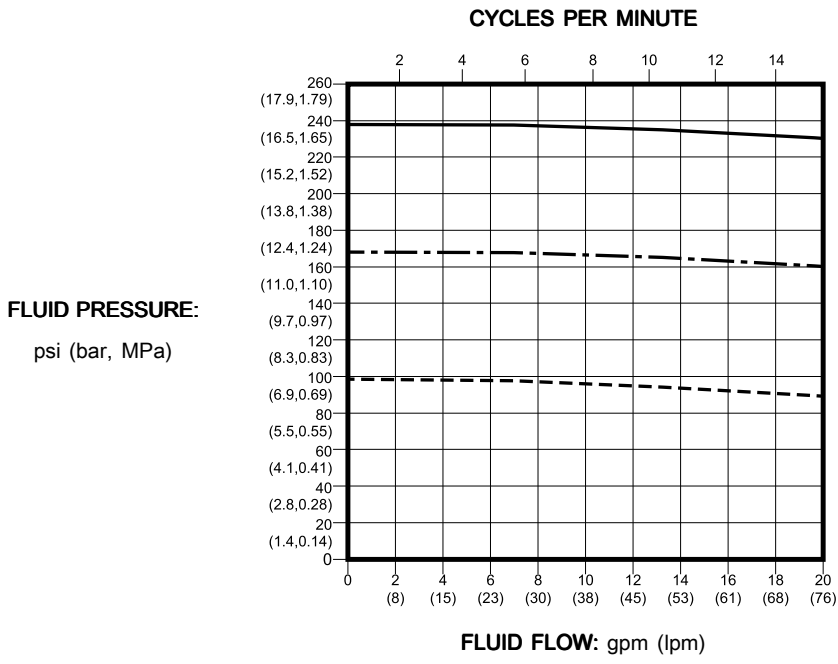

Technical Data

E-Flo DC Pumps (High Flow Rate)		
	U.S.	Metric
Maximum fluid working pressure:		
Models EC4xxx	400 psi	2.76 MPa, 27.6 bar
Models EC5xxx	300 psi	2.07 MPa, 20.7 bar
Models EC6xxx	210 psi	1.45 MPa, 14.5 bar
Models EC8J41	240 psi	1.65 MPa, 16.5 bar
Maximum continuous cycle rate (all except EC8J41 models)	20 cpm	
Maximum continuous cycle rate (EC8J41 models)	12 cpm	
Input Voltage/Power, Models ECx9xx and ECx0xx	200–240 Vac, single phase, 50/60 Hz, 5.8 kVA (2.9 kVA per motor)	
Input Voltage/Power, Models ECxJxx	380-480 Vac, three phase, 50/60 Hz, 6.0 kVA (3.0 kVA per motor)	
Power inlet port size	3/4–14 npt(f)	
Ambient temperature range	32–104°F	0–40°C
Sound data	Less than 70 dB(A)	
Oil capacity (each motor)	1.5 quarts	1.4 liters
Oil specification	Graco Part No. 16W645 ISO 220 silicone-free synthetic gear oil	
Weight	Pump package (motor, 4000cc lower, stand, and tie rods): 440 lb	Pump package (motor, 4000cc lower, stand, and tie rods): 199.6 kg
Models with sealed 4-ball lower (ECxx4x)	500 lb	227 kg
Models with sealed 4-ball lower (EC8J41)	520 lb	236 kg
Models with open wet cup lower (ECxx6x)	440 lb	200 kg
Fluid inlet size	1.5 in. Tri-Clamp	
Fluid outlet size	1.5 in. Tri-Clamp	
Wetted parts	See Lower Pump manual.	

Graco Standard Warranty

Graco warrants all equipment referenced in this document which is manufactured by Graco and bearing its name to be free from defects in material and workmanship on the date of sale to the original purchaser for use. With the exception of any special, extended, or limited warranty published by Graco, Graco will, for a period of twelve months from the date of sale, repair or replace any part of the equipment determined by Graco to be defective. This warranty applies only when the equipment is installed, operated and maintained in accordance with Graco's written recommendations.

This warranty does not cover, and Graco shall not be liable for general wear and tear, or any malfunction, damage or wear caused by faulty installation, misapplication, abrasion, corrosion, inadequate or improper maintenance, negligence, accident, tampering, or substitution of non-Graco component parts. Nor shall Graco be liable for malfunction, damage or wear caused by the incompatibility of Graco equipment with structures, accessories, equipment or materials not supplied by Graco, or the improper design, manufacture, installation, operation or maintenance of structures, accessories, equipment or materials not supplied by Graco.

This warranty is conditioned upon the prepaid return of the equipment claimed to be defective to an authorized Graco distributor for verification of the claimed defect. If the claimed defect is verified, Graco will repair or replace free of charge any defective parts. The equipment will be returned to the original purchaser transportation prepaid. If inspection of the equipment does not disclose any defect in material or workmanship, repairs will be made at a reasonable charge, which charges may include the costs of parts, labor, and transportation.

THIS WARRANTY IS EXCLUSIVE, AND IS IN LIEU OF ANY OTHER WARRANTIES, EXPRESS OR IMPLIED, INCLUDING BUT NOT LIMITED TO WARRANTY OF MERCHANTABILITY OR WARRANTY OF FITNESS FOR A PARTICULAR PURPOSE.

Graco's sole obligation and buyer's sole remedy for any breach of warranty shall be as set forth above. The buyer agrees that no other remedy (including, but not limited to, incidental or consequential damages for lost profits, lost sales, injury to person or property, or any other incidental or consequential loss) shall be available. Any action for breach of warranty must be brought within two (2) years of the date of sale.

GRACO MAKES NO WARRANTY, AND DISCLAIMS ALL IMPLIED WARRANTIES OF MERCHANTABILITY AND FITNESS FOR A PARTICULAR PURPOSE, IN CONNECTION WITH ACCESSORIES, EQUIPMENT, MATERIALS OR COMPONENTS SOLD BUT NOT MANUFACTURED BY GRACO. These items sold, but not manufactured by Graco (such as electric motors, switches, hose, etc.), are subject to the warranty, if any, of their manufacturer. Graco will provide purchaser with reasonable assistance in making any claim for breach of these warranties.

In no event will Graco be liable for indirect, incidental, special or consequential damages resulting from Graco supplying equipment hereunder, or the furnishing, performance, or use of any products or other goods sold hereto, whether due to a breach of contract, breach of warranty, the negligence of Graco, or otherwise.

FOR GRACO CANADA CUSTOMERS

The Parties acknowledge that they have required that the present document, as well as all documents, notices and legal proceedings entered into, given or instituted pursuant hereto or relating directly or indirectly hereto, be drawn up in English. Les parties reconnaissent avoir convenu que la rédaction du présente document sera en Anglais, ainsi que tous documents, avis et procédures judiciaires exécutés, donnés ou intentés, à la suite de ou en rapport, directement ou indirectement, avec les procédures concernées.

Graco Information

For the latest information about Graco products, visit www.graco.com.
For patent information, see www.graco.com/patents.

To place an order, contact your Graco Distributor or call to identify the nearest distributor.

Phone: 612-623-6921 **or Toll Free:** 1-800-328-0211 **Fax:** 612-378-3505

All written and visual data contained in this document reflects the latest product information available at the time of publication.
Graco reserves the right to make changes at any time without notice.

Original Instructions. This manual contains English, MM 3A3453

Graco Headquarters: Minneapolis

International Offices: Belgium, China, Japan, Korea

GRACO INC. AND SUBSIDIARIES • P.O. BOX 1441 • MINNEAPOLIS, MN 55440-1441 • USA
Copyright 2015, Graco Inc. All Graco manufacturing locations are registered to ISO 9001.

www.graco.com
Revision H, November 2019