

E-Flo[®] iQ Dispense System

333587E

EN

For dispensing and metering sealants, adhesives, and other medium to high viscosity fluids. For professional use only.

Not approved for use in explosive atmospheres or hazardous (classified) locations.

See page 5 for system component information.



Important Safety Instructions

Read all warnings and instructions in this manual and in all related manuals before using the equipment. Save all instructions.

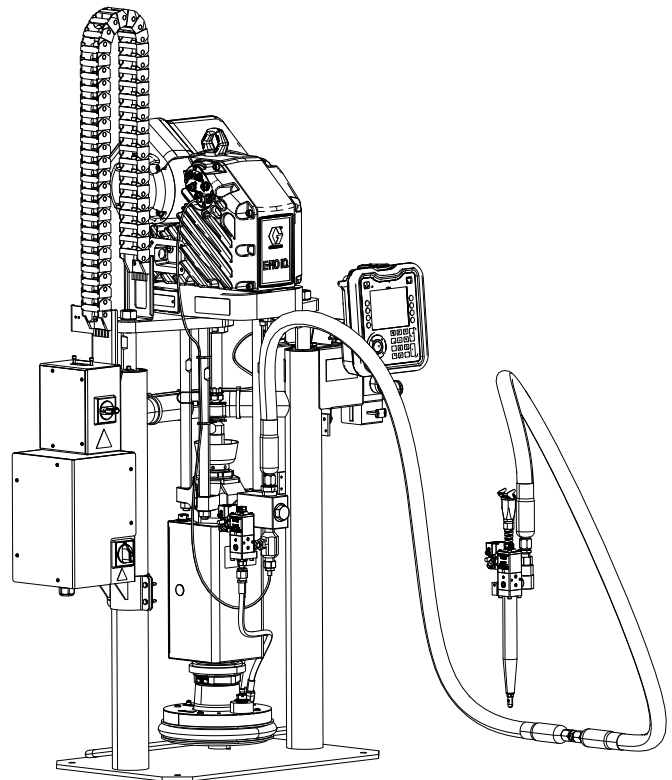

Contents

Related Manuals	3	Diagnostics	52
Dispense System Configurator	4	Pump Diagnostics Screen	52
Dispense System Components	5	Heat Diagnostics Screen	52
iQ Ram Supply Units	5	Pressure Diagnostics Screen	53
iQ Dispense Valves	6	Troubleshooting	54
Hose Options	6	View Errors	54
Dispense System Pressure	7	Troubleshoot Errors	55
Warnings	8	Error Codes	56
Dispense System Component Identification	11	USB Data	65
Tandem Ram	12	Download Procedure	65
Supply Unit Component Identification	13	USB Logs	65
iQ Ram Supply Unit	13	Event Log	65
Power Disconnect	14	Job Log	66
Integrated Air Controls (AG)	15	Automation Log	66
Integrated Air Line Accessories	15	System Configuration Settings	66
Advanced Display Module (ADM)	16	Custom Language File	66
ADM Display Details	17	Create Custom Language Strings	67
ADM LED Status Descriptions	19	Upload Procedure	67
ADM Icons	19	Integration	68
ADM Soft Keys	20	Discrete Inputs/Outputs	68
iQ Menu	22	Job Cycle Timing Diagram	70
Setup	23	Discrete Timing Diagram	71
System Setup Screen	23	Communications Gateway Module (CGM)	72
Style Definitions	24	Prime Diagram	92
Pump Settings	26	Depressurize Diagram	93
Heat Settings	28	System Enable - Remote Start Diagram	94
Advanced Setup	32	Acknowledge - Clear Error Diagram	95
Connect Light Tower Assembly	34	Manual Crossover Diagram	96
Startup	35	Data Exchange Diagram	96
Flush the Pump	35	Power Reset Diagram	97
Load Material	36	Heat CGM Timing Diagram	97
Tandem Priming when Changing Drums	38	Heat Module Acknowledge-Clear Error Diagram	98
Operation	39	Heat Zone Acknowledge-Clear Error Diagram	99
Ram Run Screen	39	Heat CGM Data Exchange Diagram	100
Tandem Run Screen	40	Connection Details	101
Run Screen Editing Mode	43	Gateway Setup Screens	104
Heat Run Screen	44	Integration Feedback Screens	107
Job Log	46	Technical Specifications	108
Events and Errors	47	Recycling and Disposal	109
Pressure Relief Procedure	48	End of Product Life	109
Shutdown the System	49	California Proposition 65	109
Maintenance	50	Graco Standard Warranty	110
Pump Maintenance Screen 1	50		
Pump Maintenance Screen 2	51		

Related Manuals

Related manuals in English:

Manual	Description
333585	iQ Dispense Valves, Instructions-Parts
333586	E-Flo iQ Dispense System, Installation-Parts
3A6321	ADM Token In-System Programming
312493	Light Tower Kit Instructions
3A1244	Graco Control Architecture Module
3A6482	APD20 Advanced Precision Driver
313138	Supply System Communications Gateway Module Installation Kit

Dispense System Configurator

The E-Flo iQ dispense system provides the flexibility to configure a complete system to meet your specific needs. This includes offering multiple combinations of the following components:

- iQ Ram Supply Units
- iQ Dispense Valves
- Hoses and connectors

For dispense system component information, see **Dispense System Components** on page 5.

First, Second and Third Digit	Fourth Digit	Fifth Digit		Sixth Digit		Seventh Digit		Eighth Digit				Ninth Digit	Digits Ten through Seventeen	Digits Eighteen through Twenty Seven		
		Single or Tandem	Heat Option		Platen Valve Option		Ram Supply Unit Options				Fieldbus Option					
			Size	Drum Size	Pump Material	Seal Material										
EQC E-Flo iQ System	Revision	S	Single	H	Heated	Y	Yes	A	3 in.	20 L (5 Gal)	CS	EPDM	A	Ether-Net/IP	Hose Options for Tandem Hoses (Digits 10-13) and Supply Hoses (Digits 14-17) (See Hose Options on page 6)	Valve Options (See the iQ Dispense Valves Instructions - Parts manual for valve model options)
		T	Tan-dem	A	Ambient			B	3 in.	20 L (5 Gal)	CS	Neo-prene	B	PROF-INET		
								C	3 in.	20 L (5 Gal)	CM	EPDM	C	PROFI-BUS		
								D	3 in.	20 L (5 Gal)	CM	Neo-prene	D	Devi-ceNet		
								F	3 in.	200 L (55 Gal)	CS	EPDM	N	None		
								G	3 in.	200 L (55 Gal)	CS	Neo-prene				
								H	3 in.	200 L (55 Gal)	CM	EPDM				
								J	3 in.	200 L (55 Gal)	CM	Neo-prene				
								K	6.5 in.	200 L (55 Gal)	CS	EPDM				
								M	6.5 in.	200 L (55 Gal)	CS	Neo-prene				
								N	6.5 in.	200 L (55 Gal)	CM	EPDM				
								P	6.5 in.	200 L (55 Gal)	CM	Neo-prene				

KEY:

CS = Carbon Steel Severe Duty®

CM = Carbon Steel MaxLife®

Dispense System Components

NOTE: The Heated option for the E-Flo iQ system is for warm melt applications with a maximum temperature of 70° C (158° F).

iQ Ram Supply Units

Check the identification plate (ID) on the back of the ram post near the Power Junction Box (AJ) for the seven-digit part number of the iQ ram supply unit. Use the following matrix to define the construction of the unit, based on the seven digits. For example, Part No. **EZC2422** represents an electric supply unit (**EZ**), a carbon steel Check-Mate 200 Severe Duty displacement pump (**C2**), a 3 in. ram (**4**), a 5-gallon platen with a neoprene seal (**2**), and an ADM (**2**).

The digits in the following matrix do not correspond to the reference numbers in the Parts drawings and lists.

EZ	C2				4				2					2		
First and Second Digit	Third and Fourth Digit				Fifth Digit				Sixth Digit					Seventh Digit		
	Check-Mate Pump Options				Ram Options				Platen and Seal Options					Interface Options		
		Size	Pump Material	Heated/Ambient	Name	Size	Drum Size	Style	Platen Size	Platen Material	Seal Material	Wiper	Heated/Ambient	Interface		
EZ (Electric Supply System)	C1	200cc	CS	Ambient	1	D60	3 in. 20 L (5 Gal)	Ambient	1	20 L (5 Gal)	CST/AL	Neoprene	Single Ring	Ambient	2	ADM
	C2	200cc	CS	Heated <70° C	2	D200	3 in. 200 L (55 Gal)	Ambient	2	20 L (5 Gal)	CST/AL	Neoprene	Single Ring	Heated <70° C	4	No ADM
	C3	200cc	CM	Ambient	3	D200s	6.5 in. 200 L (55 Gal)	Ambient	3	20 L (5 Gal)	CST/AL	EPDM	Single Ring	Ambient		
	C4	200cc	CM	Heated <70° C	4	D60	3 in. 20 L (5 Gal)	Heated <70° C	4	20 L (5 Gal)	CST/AL	EPDM	Single Ring	Heated <70° C		
					5	D200	3 in. 200 L (55 Gal)	Heated <70° C	5	200 L (55 Gal)	AL	Neoprene	Double Ring	Ambient		
					6	D200s	6.5 in. 200 L (55 Gal)	Heated <70° C	6	200 L (55 Gal)	AL	Neoprene	Double Ring	Heated <70° C		
									7	200 L (55 Gal)	AL	EPDM	Double Ring	Ambient		
									8	200 L (55 Gal)	AL	EPDM	Double Ring	Heated <70° C		

KEY:

- CS = Carbon Steel Severe Duty
- CM = Carbon Steel MaxLife
- CST/AL = Carbon Steel/Aluminum
- AL = Aluminum

iQ Dispense Valves

Check the identification plate on the valve for the ten-digit part number of the iQ dispense valve. Use the following matrix to define the construction of the valve, based on the ten digits. For example, Part No. **V25AB060BA** represents a valve (**V**) with 1/4 in. NPT inlet ports (**25**), NPT tip (**A**), ball/seat type (**B**), 60 mm outlet block length (**060**), solenoid (**B**), with no heat (**A**).

First Digit	Second and Third Digit		Fourth Digit		Fifth Digit		Sixth, Seventh, and Eighth Digit		Ninth Digit		Tenth Digit	
	Size		Tip Size		Type		Outlet Block Length		Action		Heat	
V	25	1/4 in. NPT	A	1/4 in. NPT	B	Ball/Seat	000	NA	B	Valve Mounted Solenoid	A	None
			C	0.6 mm	S	Snuff-Back	060	60 mm	D	*Remote Solenoid Block	B	Heated
			D	1.0 mm	T	Tip Seal	200	200 mm				
			F	1.3 mm								
			G	1.7 mm								

* Remote solenoid supplied by customer.

NOTE: Refer to the iQ Dispense Valves Instructions-Parts manual for additional information about iQ Dispense Valves. See **Related Manuals** on page 3.

Hose Options

Part No.	JIC Dash Size	Length	Heat	Working Pressure Temperature Rating
04	19M404	-10 (5/8 in, 15.9 mm)	6 ft	Heated
05	19M405	-10 (5/8 in, 15.9 mm)	10 ft	Heated
06	19M406	-10 (5/8 in, 15.9 mm)	15 ft	Heated
07	19M407	-10 (5/8 in, 15.9 mm)	20 ft	Heated
08	19M408	-10 (5/8 in, 15.9 mm)	25 ft	Heated
11	19M411	-12 (3/4 in, 19.0 mm)	6 ft	Heated
12	19M412	-12 (3/4 in, 19.0 mm)	10 ft	Heated
13	19M413	-12 (3/4 in, 19.0 mm)	15 ft	Heated
14	19M414	-12 (3/4 in, 19.0 mm)	20 ft	Heated
15	19M415	-12 (3/4 in, 19.0 mm)	25 ft	Heated
16	19M416	-16 (1 in, 25.4 mm)	6 ft	Heated
17	19M417	-16 (1 in, 25.4 mm)	10 ft	Heated
18	19M418	-16 (1 in, 25.4 mm)	15 ft	Heated
19	19M419	-16 (1 in, 25.4 mm)	20 ft	Heated
20	19M420	-16 (1 in, 25.4 mm)	25 ft	Heated

4000 psi (28 MPa, 276 bar) at -65° F - 212° F (-54° C - 100° C)

3000 psi (21 MPa, 207 bar) at 213° F - 400° F (101° C - 204° C)

Part No.	JIC Dash Size	Length	Heat	Working Pressure Temperature Rating
65	17K265	-10 (5/8 in, 15.9 mm)	6 ft	Ambient
66	17K266	-10 (5/8 in, 15.9 mm)	10 ft	Ambient
67	17K267	-10 (5/8 in, 15.9 mm)	15 ft	Ambient
68	17K268	-10 (5/8 in, 15.9 mm)	20 ft	Ambient
69	17K269	-10 (5/8 in, 15.9 mm)	25 ft	Ambient
72	17K272	-12 (3/4 in, 19.0 mm)	6 ft	Ambient
73	17K273	-12 (3/4 in, 19.0 mm)	10 ft	Ambient
74	17K274	-12 (3/4 in, 19.0 mm)	15 ft	Ambient
75	17K275	-12 (3/4 in, 19.0 mm)	20 ft	Ambient
76	17K276	-12 (3/4 in, 19.0 mm)	25 ft	Ambient
77	17K277	-16 (1 in, 25.4 mm)	6 ft	Ambient
78	17K278	-16 (1 in, 25.4 mm)	10 ft	Ambient
79	17K279	-16 (1 in, 25.4 mm)	15 ft	Ambient
80	17K280	-16 (1 in, 25.4 mm)	20 ft	Ambient
81	17K281	-16 (1 in, 25.4 mm)	25 ft	Ambient
00	No Hose	N/A	N/A	N/A

4000 psi (28 MPa, 276 bar) at -65° F - 400° F (101° C - 204° C)



Dispense System Pressure







Due to factors such as the dispense system design, the material being pumped, and the flow rate, the dynamic pressure will not reach the rated working (stall) pressure of the system.

		Pump Working (Stall) Pressure			Max Dynamic (Run) Pressure		
Lower Size		psi	bar	MPa	psi	bar	MPa
Check-Mate	200CS/CM	4,000	290	29.0	3,905	269	26.9

Warnings

The following warnings are for the setup, use, grounding, maintenance, and repair of this equipment. The exclamation point symbol alerts you to a general warning and the hazard symbols refer to procedure-specific risks. When these symbols appear in the body of this manual or on warning labels, refer back to these Warnings. Product-specific hazard symbols and warnings not covered in this section may appear throughout the body of this manual where applicable.

 <h1 style="margin: 0;">DANGER</h1>	
	<p>SEVERE ELECTRIC SHOCK HAZARD</p> <p>This equipment can be powered by more than 240 V. Contact with this voltage will cause death or serious injury.</p> <ul style="list-style-type: none"> • Turn off and disconnect power at main switch before disconnecting any cables and before servicing equipment. • This equipment must be grounded. Connect only to grounded power source. • All electrical wiring must be done by a qualified electrician and comply with all local codes and regulations.

 <h1 style="margin: 0;">WARNING</h1>	
    	<p>SKIN INJECTION HAZARD</p> <p>High-pressure fluid from dispensing device, hose leaks, or ruptured components will pierce skin. This may look like just a cut, but it is a serious injury that can result in amputation. Get immediate surgical treatment.</p> <ul style="list-style-type: none"> • Do not point dispensing device at anyone or at any part of the body. • Do not put your hand over the fluid outlet. • Do not stop or deflect leaks with your hand, body, glove, or rag. • Follow the Pressure Relief Procedure when you stop dispensing and before cleaning, checking, or servicing equipment. • Tighten all fluid connections before operating the equipment. • Check hoses and couplings daily. Replace worn or damaged parts immediately.

! WARNING



MOVING PARTS HAZARD

Moving parts can pinch, cut or amputate fingers and other body parts.

- Keep clear of moving parts.
- Do not operate equipment with protective guards or covers removed.
- Equipment can start without warning. Before checking, moving, or servicing equipment, follow the **Pressure Relief Procedure** and disconnect all power sources.



FIRE AND EXPLOSION HAZARD

Flammable fumes, such as solvent and paint fumes, in **work area** can ignite or explode. Paint or solvent flowing through the equipment can cause static sparking. To help prevent fire and explosion:

- Use equipment only in well-ventilated area.
- Eliminate all ignition sources; such as pilot lights, cigarettes, portable electric lamps, and plastic drop cloths (potential static sparking).
- Ground all equipment in the work area. See **Grounding** instructions.
- Never spray or flush solvent at high pressure.
- Keep work area free of debris, including solvent, rags and gasoline.
- Do not plug or unplug power cords, or turn power or light switches on or off when flammable fumes are present.
- Use only grounded hoses.
- Hold gun firmly to side of grounded pail when triggering into pail. Do not use pail liners unless they are anti-static or conductive.
- **Stop operation immediately** if static sparking occurs or you feel a shock. Do not use equipment until you identify and correct the problem.
- Keep a working fire extinguisher in the work area.







EQUIPMENT MISUSE HAZARD

Misuse can cause death or serious injury.

- Do not operate the unit when fatigued or under the influence of drugs or alcohol.
- Do not exceed the maximum working pressure or temperature rating of the lowest rated system component. See **Technical Specifications** in all equipment manuals.
- Use fluids and solvents that are compatible with equipment wetted parts. See **Technical Specifications** in all equipment manuals. Read fluid and solvent manufacturer's warnings. For complete information about your material, request Safety Data Sheets (SDSs) from distributor or retailer.
- Turn off all equipment and follow the **Pressure Relief Procedure** when equipment is not in use.
- Check equipment daily. Repair or replace worn or damaged parts immediately with genuine manufacturer's replacement parts only.
- Do not alter or modify equipment. Alterations or modifications may void agency approvals and create safety hazards.
- Make sure all equipment is rated and approved for the environment in which you are using it.
- Use equipment only for its intended purpose. Call your distributor for information.
- Route hoses and cables away from traffic areas, sharp edges, moving parts, and hot surfaces.
- Do not kink or over bend hoses or use hoses to pull equipment.
- Keep children and animals away from work area.
- Comply with all applicable safety regulations.



 <h1 style="margin: 0;">WARNING</h1>	
	<p>SPLATTER HAZARD Hot or toxic fluid can cause serious injury if splashed in the eyes or on skin. During blow off of platen, splatter may occur.</p> <ul style="list-style-type: none"> • Use minimum air pressure when removing platen from drum.
	<p>TOXIC FLUID OR FUMES HAZARD Toxic fluids or fumes can cause serious injury or death if splashed in the eyes or on skin, inhaled, or swallowed.</p> <ul style="list-style-type: none"> • Read Safety Data Sheets (SDSs) to know the specific hazards of the fluids you are using. • Store hazardous fluid in approved containers, and dispose of it according to applicable guidelines.
	<p>BURN HAZARD Equipment surfaces and fluid that is heated can become very hot during operation. To avoid severe burns:</p> <ul style="list-style-type: none"> • Do not touch hot fluid or equipment.
	<p>PERSONAL PROTECTIVE EQUIPMENT Wear appropriate protective equipment when in the work area to help prevent serious injury, including eye injury, hearing loss, inhalation of toxic fumes, and burns. Protective equipment includes but is not limited to:</p> <ul style="list-style-type: none"> • Protective eyewear, and hearing protection. • Respirators, protective clothing, and gloves as recommended by the fluid and solvent manufacturer.

Dispense System Component Identification

NOTE: Figure 1 shows a typical E-Flo iQ dispense system installation with an iQ ram supply unit, hoses, connectors, and an iQ dispense valve. Some installations may require only one hose depending on the needs of the system.

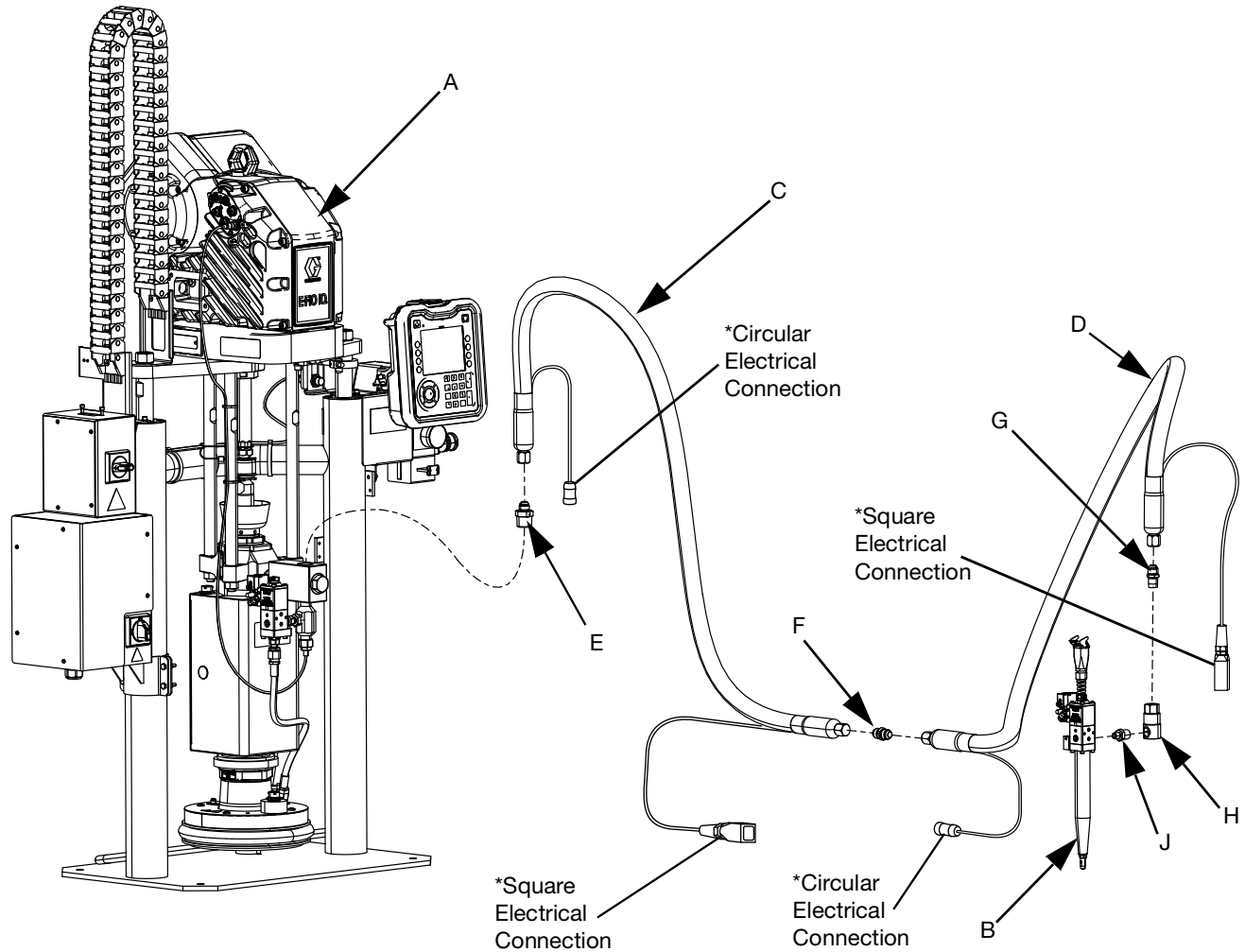

FIG. 1: E-Flo iQ Dispense System

Key:

- A iQ Ram Supply Unit
- B iQ Dispense Valve
- C First Hose from Supply System
- D Second Hose to iQ Dispense Valve
- E Ram Supply System Fitting to First Hose

- F First Hose Fitting to Second Hose
- G Second Hose Fitting to Swivel
- H Swivel Fitting
- J Swivel to Valve Fitting

* Applies to heated hoses only.

Tandem Ram

NOTE: FIG. 2 shows a typical E-Flo iQ dispense system installation with a Tandem iQ ram supply unit, hoses, connectors, and an iQ dispense valve. Some installations may not require Supply Hose 2 (D) to iQ Dispense Valve (B) depending on the needs of the system.

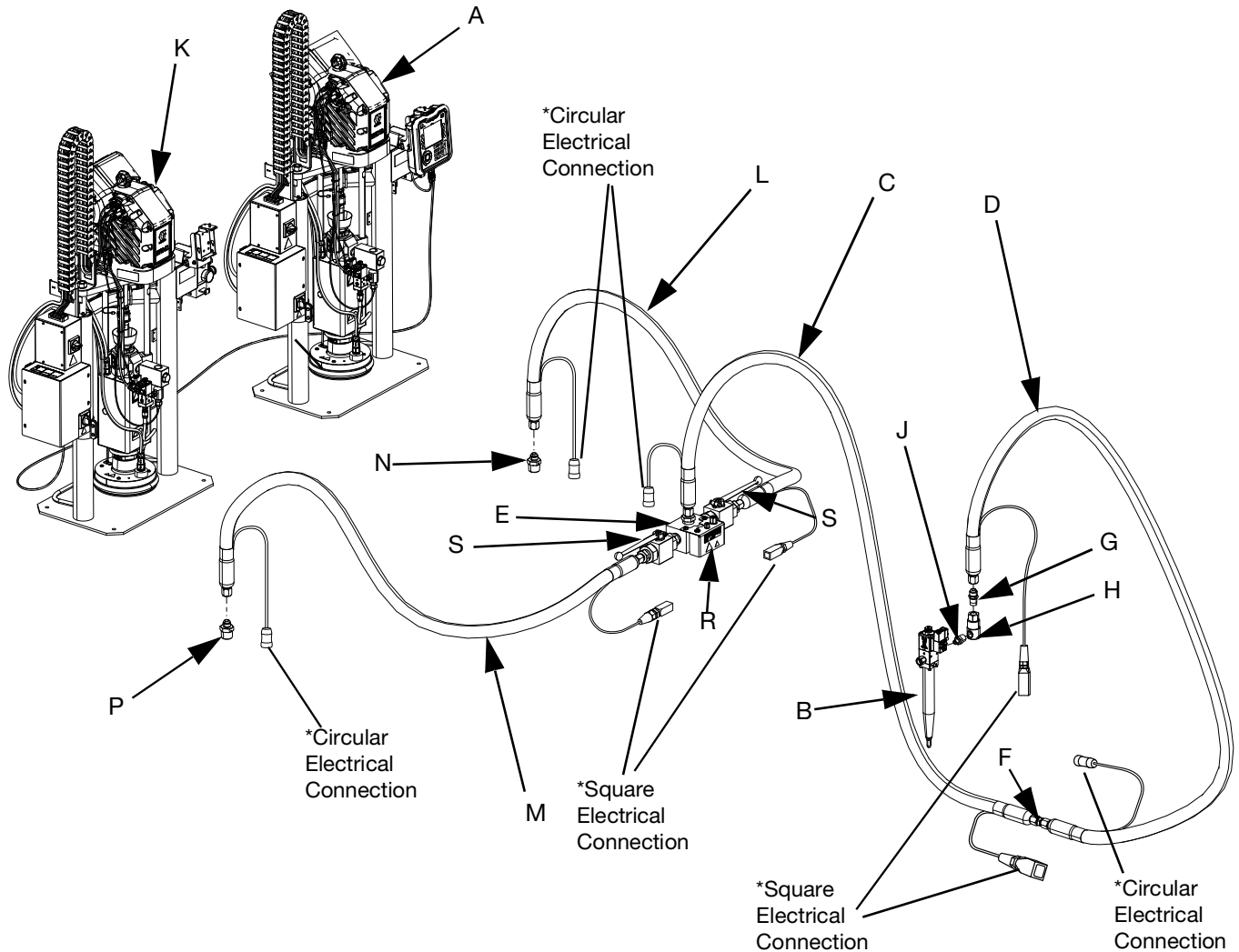

FIG. 2: Tandem E-Flo iQ Dispense System

Key:

- | | | | |
|---|--|---|--|
| A | iQ Ram Supply Unit 1 | L | Tandem Hose 1 |
| B | iQ Dispense Valve | M | Tandem Hose 2 |
| C | Supply Hose 1 | N | Ram Supply Unit 1 Fitting to Tandem Hose 1 |
| D | Supply Hose 2 | P | Ram Supply Unit 2 Fitting to Tandem Hose 2 |
| E | Tandem Block Fitting to Supply Hose 1 | R | Tandem Block |
| F | Supply Hose 1 Fitting to Supply Hose 2 | S | Ball Valves |
| G | Supply Hose 2 Fitting to Swivel | | |
| H | Swivel Fitting | | |
| J | Swivel Fitting to Valve | | |
| K | iQ Ram Supply Unit 2 | | |

* Applies to heated hoses only.

Supply Unit Component Identification

iQ Ram Supply Unit

D200 3 in. Dual Post Shown

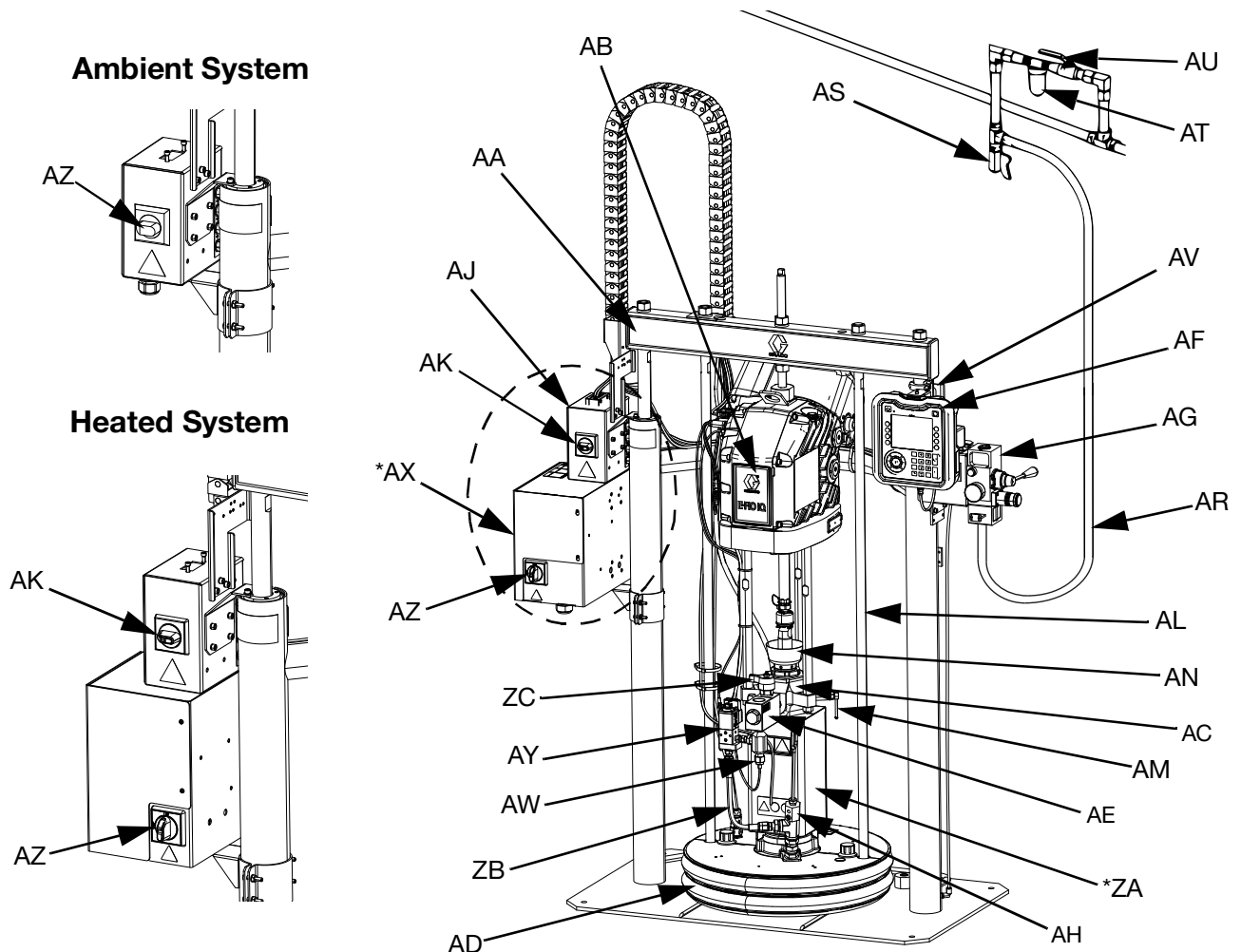

FIG. 3: iQ Ram Supply Unit

Key:

AA Ram Assembly	AR Air Line (not supplied)
AB Electric Driver	AS Air Line Drain Valve (not supplied)
AC Displacement Pump	AT Air Filter (not supplied)
AD Platen	AU Bleed Type Air Shutoff Valve (required) (not supplied)
AE Fluid Check Valve	AV Level Sensors
AF Advanced Display Module (ADM)	AW Outlet Pressure Transducer
AG Integrated Air Controls (see Figure 6)	AX *Heat Control Box
AH Platen Bleed Port	AY Platen Valve Kit (optional)
AJ Power Junction Box	AZ Disconnect Switch (See Power Disconnect on page 14)
AK Power Junction Box Switch	ZA *Pump Heater
AL Platen Lift Rod	ZB Recirculation Hose
AM Pump Bleed Valve	ZC Pump Relief Valve
AN Wet Cup	

* Parts on heated systems only.

Power Disconnect

Every E-Flo iQ Dispense System has a red and yellow Disconnect Switch which shuts off power to the entire system. The location of the switch is different for ambient and heated systems. See Figure 4.

On ambient systems, the Disconnect Switch (AZ) is located on the Power Junction Box (AJ).

On heated systems, the Disconnect Switch (AZ) is located on the Heat Control Box (AX). Heated systems also have a red and black Power Junction Box Switch (AK) located on the Power Junction Box (AJ). The Power Junction Box Switch (AK) removes power to everything EXCEPT heat. The Disconnect Switch (AZ) removes power to the entire system, including heat.

Ambient System

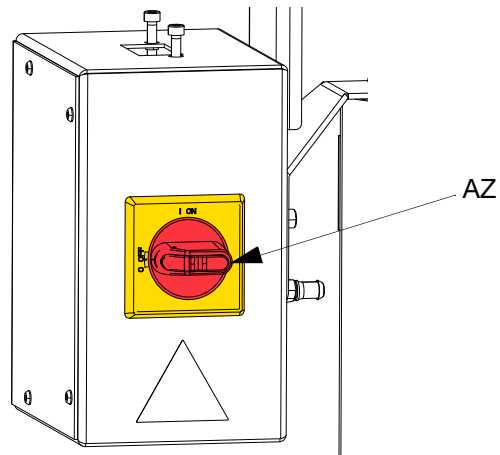

Heated System

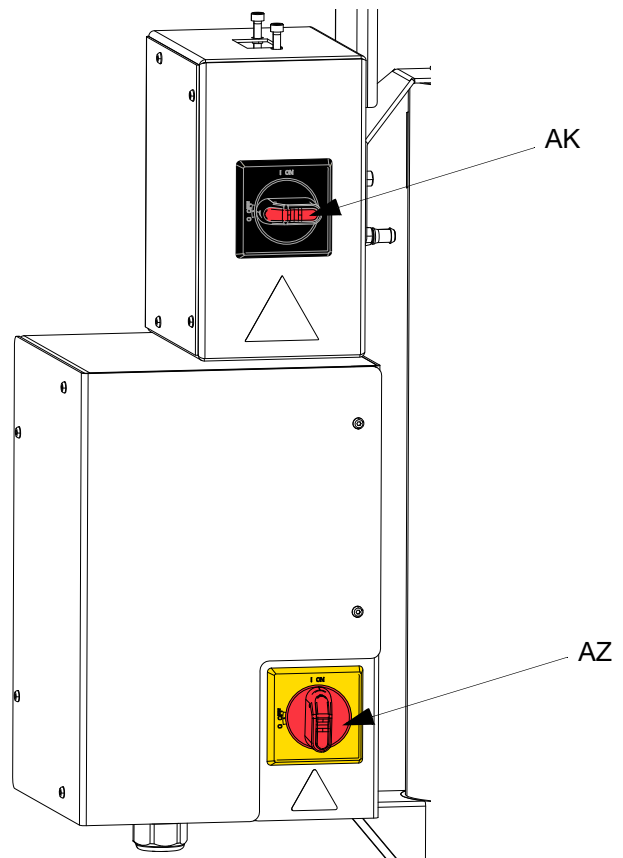

FIG. 4. Power Disconnect

Integrated Air Controls (AG)

The integrated air controls include:

- **Main Air Slider Valve (BA):** turns air on and off to the system. When closed, the valve relieves pressure downstream.
- **Ram Air Regulator (BB):** controls Ram up and down pressure and blowoff pressure.
- **Ram Director Valve (BC):** controls Ram direction.
- **Exhaust Port with Muffler (BD)**
- **Blowoff Button (BE):** turns air on and off to push the Platen (D) out of an empty drum.

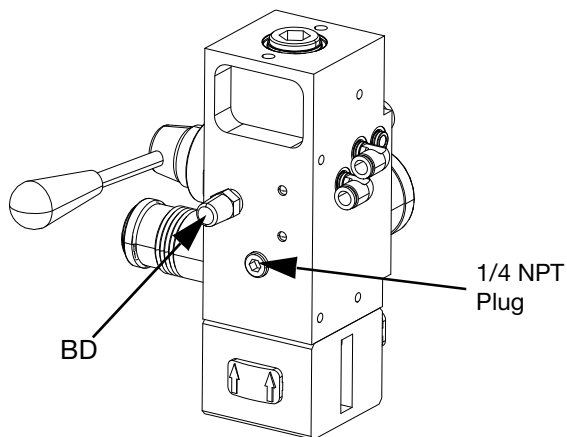
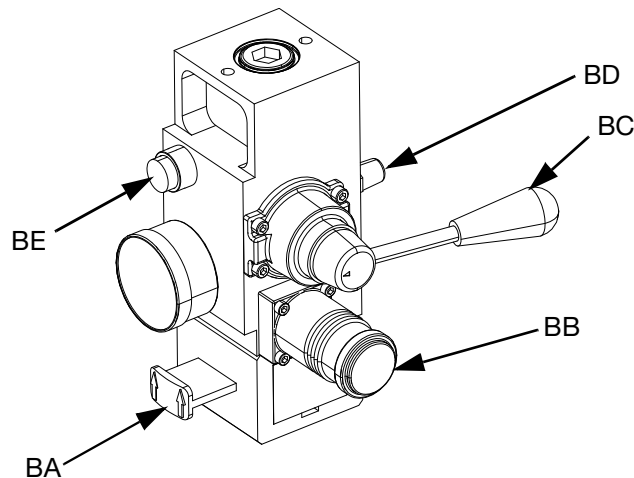

FIG. 5. Integrated Air Control Module

Integrated Air Line Accessories

See FIG. 3.

- **Air Line Drain Valve (AS):** removes condensed water from the air line. Not supplied.
- **Air Line Filter (AT):** removes harmful dirt and moisture from the compressed air supply. Not supplied.
- **Second Bleed-type Air Valve (AU) (required):** isolates Air Line accessories for servicing. Locate upstream from all other Air Line accessories. Not supplied.

Advanced Display Module (ADM)

Front and Rear Views

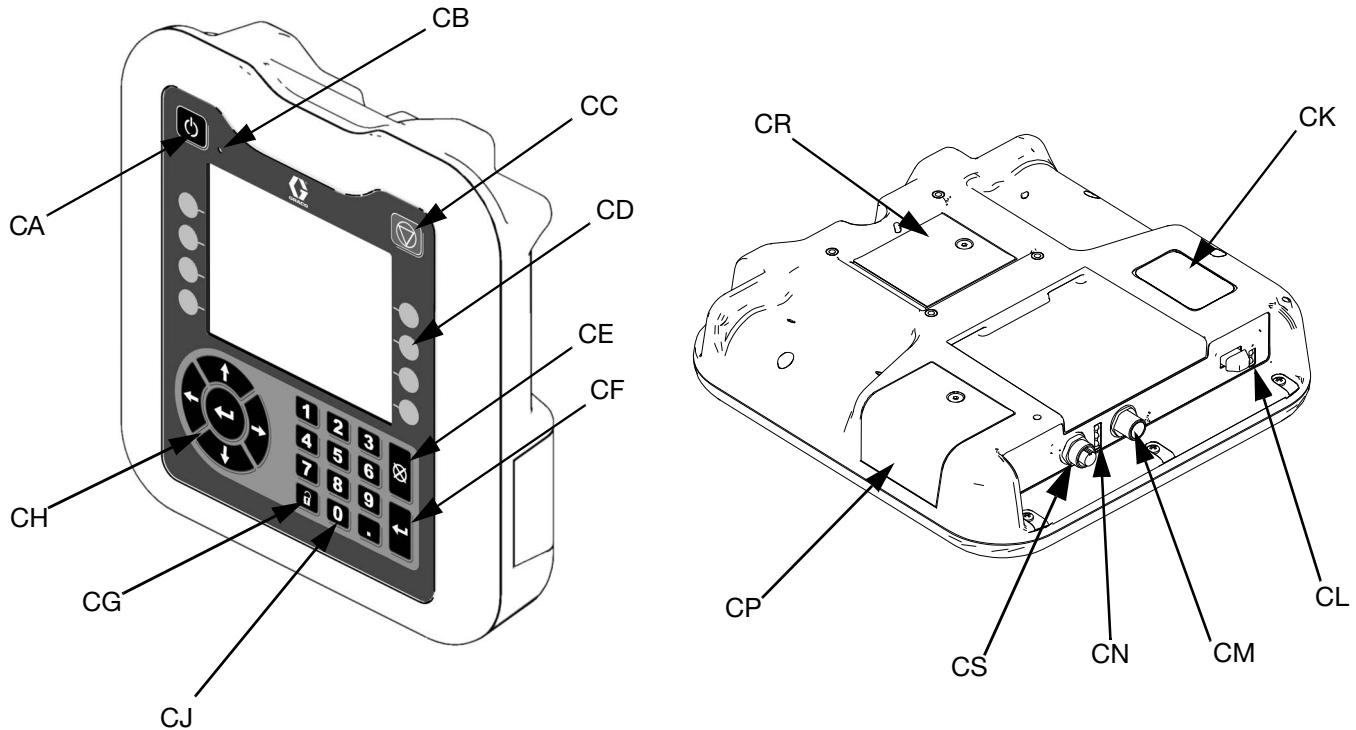

Fig. 6: ADM Component Identification

Key:

CA Startup/Shutdown

Starts up or shuts down the system. Toggles between Active and Inactive system.

CB System Status Indicator LED

CC Pump Soft Stop

Stops all pump processes and disables the pump. Also stops all heating processes and disables the heat. This is not a safety or emergency stop.

CD Soft Keys

Defined by the icon on the screen next to the soft key. Performs the specific operation for that icon when pressed.

CE Cancel

Cancels a selection or number entry while in the process of entering a number or making a selection. Cancels the pump processes. Exits a screen without saving changes.

CF Enter

Select to update a field, accept a selection or value, acknowledge an event, enter a screen, and toggle selected items.

CG Lock/Setup

Toggles between Run screens and the iQ Menu.

CH Directional Keypad

Navigate within a screen or to a new screen.

CJ Numeric Keypad

Input numeric values.

CK Part Number Identification Label

CL USB Interface

CM CAN Cable Connection

Power and communication.

CN Module Status LEDs

Visual indicators to show the status of the ADM.

CP Token Access Cover

Access cover for blue software token.

CR Battery Access Cover

CS Light Tower Connection

NOTE: If using a Tandem system, the ADM is only included with the iQ Ram Supply Unit 1 (A)

ADM Display Details

Use the Blue Token

The E-Flo iQ system includes a blue token that must be inserted into the ADM to initiate the E-Flo iQ software.

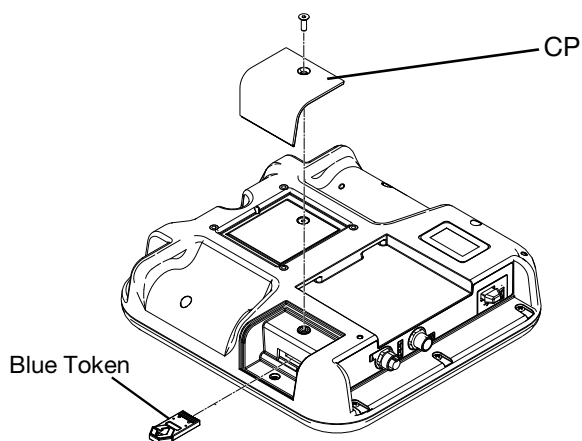

1. Remove the ADM from the bracket.
2. Use a hex wrench to remove the screws from the token access cover (CP).
3. Remove the access cover (CP).
4. Insert and press the blue software token firmly into the slot.
5. Replace the token access cover (CP) and insert and tighten the screw that holds it in place.
6. Mount the ADM on the bracket.

Power Up Screen

This screen appears when the ADM is powered up.



Five seconds after the E-Flo iQ blue token is inserted into the ADM, the Graco power up screen switches to the E-Flo iQ power up screen. This screen remains on while the ADM runs through initialization and establishes communication with other modules in the system.



Menu Bar

The Menu Bar appears at the top of each screen (the following image is only an example).

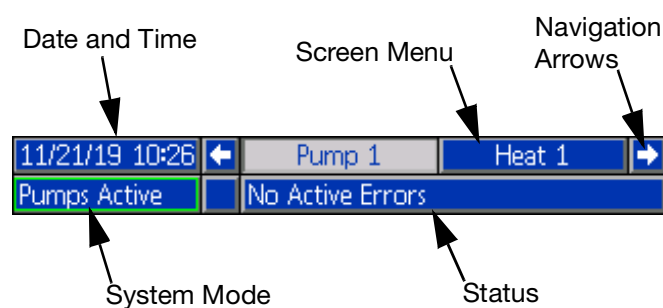

Date and Time

The date and time are always displayed in one of the following formats. The time is always displayed as a 24-hour clock.

- DD/MM/YY HH:MM
- YY/MM/DD HH:MM
- MM/DD/YY HH:MM

Navigation Arrows

The left and right arrows are only visible when screen navigation is allowed.

Screen Menu

The screen menu indicates the currently active screen, which is highlighted. It also indicates the associated screens that are available by scrolling left and right.

System Mode



The current system mode is displayed in the lower left of the Menu Bar. System modes include: Pump Active, Pump Inactive, Job in Cycle, Pre-charge, Heat Inactive, Heat Off, Heat Soak, Heat at Temp, Heat in Setback.

Status

The current system status is displayed in the lower right of the Menu Bar.

Alarm/Deviation

The current system error is displayed in the middle of the Menu Bar. There are four possibilities.

Icon	Function
No Icon	No information or no error has occurred
	Advisory
	Deviation
	Alarm

Soft Keys

Icons next to the soft keys indicate which mode or action is associated with each soft key. Soft keys that do not have an icon next to them are not active in the current screen. See **Advanced Display Module** on page 16 and **ADM Soft Keys** on page 20.

NOTICE
To prevent damage to the soft key buttons, do not press buttons with sharp objects such as pens, plastic cards, or fingernails.

Navigating the Screens

There are two types of screens:

Run screens control operations and display system status and data.

Setup screens control system parameters and advanced features. These screens are accessed through the iQ Menu.

Press  on any Run screen to switch to the iQ Menu screens. If the system has a password lock, the Password screen is displayed. If the system is not locked (password is set to 0000), iQ Menu Screen 1 is displayed. Refer to **iQ Menu** on page 22 for additional information.



Press  on any Setup screen to return to the Run screen.

Press the Enter soft key  to activate the editing function on any screen.

Press the Exit soft key  to exit the editing function and save any changes.

Use the other soft keys to select the function adjacent to them.

Use  to exit a screen. Using this key while in editing mode will exit the screen without saving changes.

Use the   keys on the ADM to move through the settings on a screen or drop down menu and to scroll through multiple screens on the right side of the display.

Use the  key to choose a field to update, to make a selection, to save a selection or value, to enter a screen, or to acknowledge an event.

Set Password



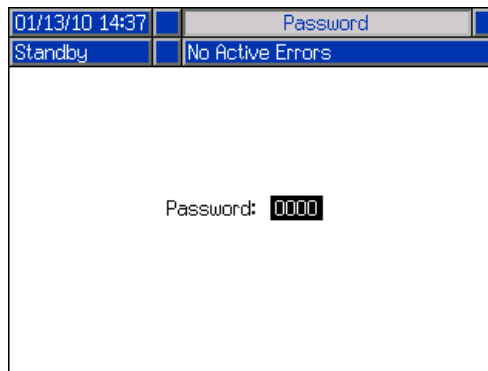





You can set passwords to protect access to some selections on the iQ Menu screens. See **iQ Menu** on page 22. It can also be used when changing from Remote to Local control mode to protect against inadvertently changing control modes. To set or remove the password, select Advanced from iQ Menu 2. See **Advanced Setup Screen 2** on page 32. Multiple levels of passwords can be set up.





ADM LED Status Descriptions

















LED	Conditions	Description
System Status 	Green Solid	Run Mode, System On
	Green Flashing	Setup Mode, System On
	Yellow Solid	Run Mode, System Off
	Yellow Flashing	Setup Mode, System Off
USB Status (CL)	Green Flashing	Data recording in progress
	Yellow Solid	Downloading information to USB
	Green and Yellow Flashing	ADM is busy, USB cannot transfer information when in this mode
ADM Status (CN)	Green Solid	Power applied to module
	Yellow Flashing	Active Communication
	Red Steady Flashing	Software upload from token in progress
	Red Random Flashing or Solid	Module error exists























ADM Icons













Icon	Function
	Alarm - See Troubleshooting , page 54 for more information.
	Deviation - See Troubleshooting , page 54 for more information.
	Advisory - See Troubleshooting , page 54 for more information.
	Target for primary pressure and flow. Only displayed in priming mode.
	Communication Error
	No issues found with parameter or setting value
	Missing or unexpected parameter or setting value
	System is processing request (animated)
	Pump position (animated). The pump coupler will move up and down in real time and indicate the approximate position of the pump. The pump will need to complete one full down stroke upon each power cycle before the position is valid.

Icon	Function
	Zone setpoint temperature showing the temperature the zone heats too when the heat is turned on.
	Zone setback temperature showing the setback the zone goes to when the heat is in setback mode.

ADM Soft Keys

Icon	Function
Pump Operation Icon	
	<i>Green:</i> Start the Pump
	<i>Inverted Red:</i> Stop the Pump
	<i>Red with Border (enabled):</i> Indicates that the pump cannot be started due to an alarm.
	<i>Red with No Border (not enabled):</i> Indicates that the system is not enabled and the pump cannot be started.
	<i>Yellow:</i> Indicates that the pump has an active alarm but still allows the valve and platen to be depressurized. The pump can still be primed only if it is a “pump not primed” alarm.
 	Enter or exit editing mode for a particular screen.
	Access the Style Definitions screens.
	Access the Pump Setup screens.
	Access the Heat Setup screens.
	Access the Diagnostics function.
	Access the Events logs.
	Access the Errors logs.
	Access the Job Log.
	Access the Troubleshooting function.
	Access the System Setup screen.

Icon	Function
	Access the Advanced System Setup screens.
	Access the Maintenance function.
	Access the Fieldbus Gateway Setup screens.
	Access the Integration Feedback screens.
	Globalize selection. Apply a style setting to all of the styles in Style Definitions or a heat setting to all of the heat zones in Heat Settings.
	Confirm globalizing a setting.
	Cancel globalizing a setting.
	Access a keyboard screen to create or change a style name.
	Reset offsets to zero when calibrating pressure transducers.
 	Tandem systems only. Toggle between Pump 1 and Pump 2.
 	Local / Remote control toggle.
	Pump is locked in remote control via fieldbus interface.
 	Enter or exit pump priming mode. A “1” or “2” will show on the icon in Tandem systems to indicate which pump will be primed.
 	Enter or exit drum depressurization mode. (If equipped with optional fluid solenoid.) A “1” or “2” will show on the icon in Tandem systems to indicate which pump will be depressurized.
 	Enter or exit valve depressurization mode.
 	Turn heat zones on and off.

Icon	Function
	Place all heat zones into setback and out of setback.
	Enter or exit manual pump movement mode.
	Move to the top.
	Move upward.
	Move downward.
	Move to the bottom.
	Reset Cycle Counter.
	Toggle between lifetime and resettable.
	Calibrate.
	Continue.
	Previous screen.
	Search.

iQ Menu

The iQ Menu screens provide access to settings that help to ensure the proper operation and maintenance of the system. These functions can be performed when the ADM is either in Active or System OFF Mode.

1. Provide power to the system to turn on the ADM.
2. Press  on the ADM from any Run screen to go to the iQ Menu screens.

If you set a password, the menu will be displayed with red locks above the menu selections with parameters that can be changed. Enter your password when prompted to access these screens.

The selections that do not have a red lock have information that can be viewed but not changed and would not require a password. See **Advanced Setup Screen 2** on page 32 for information about setting passwords.

iQ Menu Screen 1

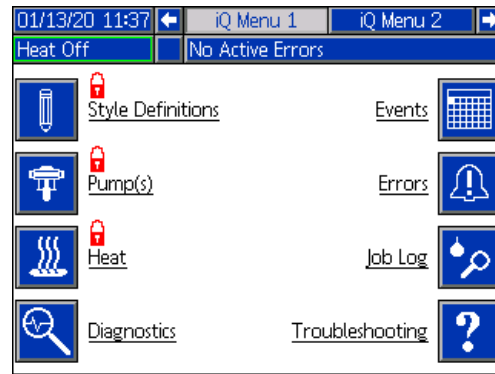
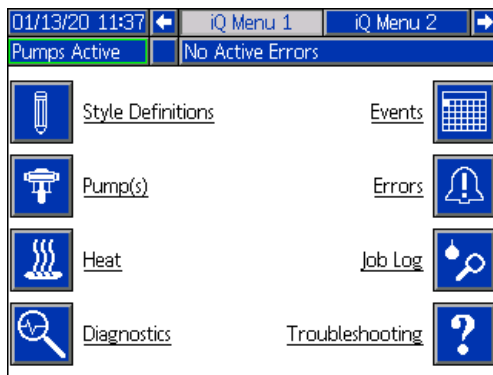

iQ Menu Screen 2

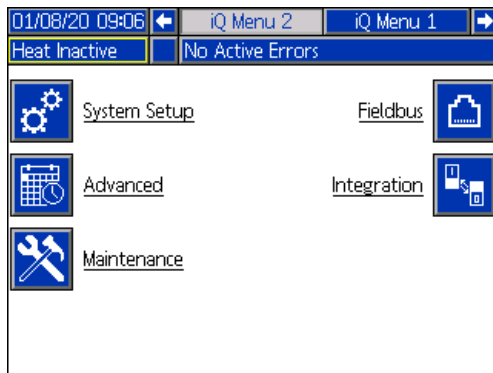

Setup



To prevent personal injury from pressurized fluid such as skin injection or splashing fluid, make sure that all components in your system are rated to the maximum pressure the system is capable of attaining. All components must be rated for maximum pressure even if the pump is operated below maximum pressure.

NOTICE

To prevent damage to ADM buttons, do not press the buttons with sharp objects such as pens, plastic cards, or fingernails.

NOTICE

To prevent damage to components in the system, all components must be rated to the maximum pressure the system is capable of attaining.

It is important to set up the parameters of your system before operating the E-Flo iQ system. These are accessed through the iQ Menu. After starting up the

ADM, press the  key from the Run screen to go to the iQ Menu screens. Refer to **iQ Menu** on page 22.

System Setup Screen

Press the  soft key at the iQ Menu screen 2 to access the System Setup screen.

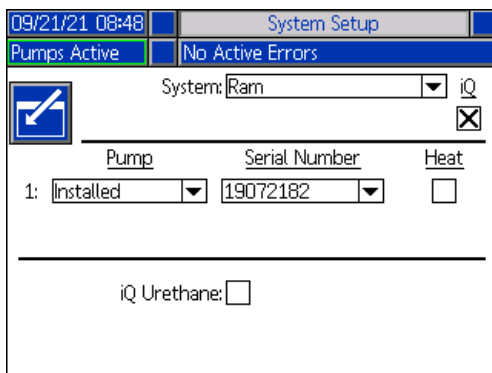

09/21/21 08:48 System Setup

Pumps Active No Active Errors

System: Ram iQ

Pump	Serial Number	Heat
1: Installed	19072182	<input type="checkbox"/>

iQ Urethane:

Press the  soft key to enter editing mode.

Use the drop down menu to select the type of system as either Ram or Tandem.

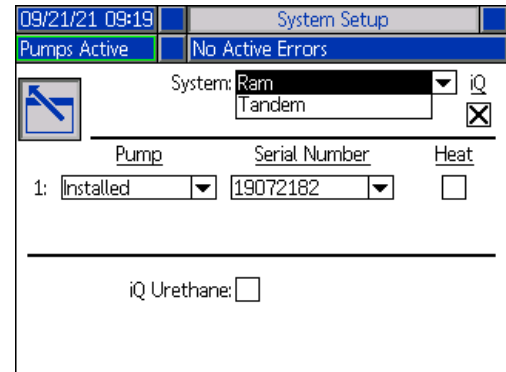

09/21/21 09:19 System Setup

Pumps Active No Active Errors

System: Ram iQ

Pump	Serial Number	Heat
1: Installed	19072182	<input type="checkbox"/>

iQ Urethane:

NOTE: Changing the system type resets the pumps in the system.

When you select Ram, the only action required at this screen is if the pump has a heat module installed. Press the  key in the Heat box to configure it for heat.

All other fields are automatically set when the blue token is inserted on an installed system. The System is displayed as Ram. The box below the iQ icon next to the System field indicates that it is an E-Flo iQ system.

The Pump shows as Installed. The Serial Number should match the serial number printed on the driver ID tag. As a backup to the driver serial number, the serial number of the current board will be displayed instead. The serial number for the control board is also displayed in the detailed software status screens. See **Advanced Setup Screen 4** on page 34.

When you select Tandem, a field for the second pump is displayed on the screen showing Uninstalled. Select Installed from the drop down menu.

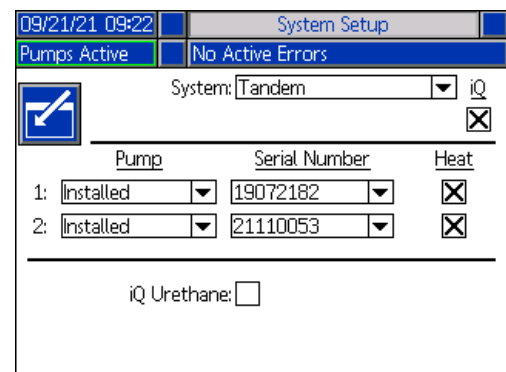

09/21/21 09:22 System Setup

Pumps Active No Active Errors

System: Tandem iQ

Pump	Serial Number	Heat
1: Installed	19072182	<input checked="" type="checkbox"/>
2: Installed	21110053	<input checked="" type="checkbox"/>

iQ Urethane:

Setup

When you select installed, the Serial Number will be automatically populated to match the serial number printed on the driver ID tag on Pump 2.

If Pump 2 has a heat module installed, press the  key in the Heat box to enable it.

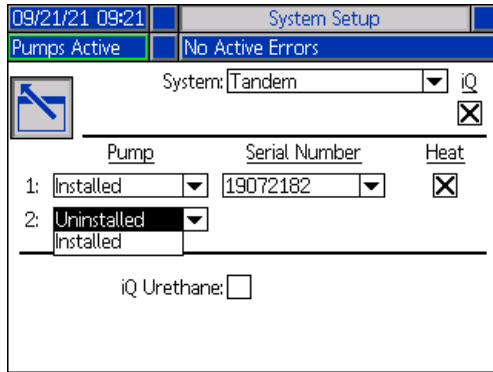

Press the  soft key to exit editing mode.

Style Definitions

Press the  soft key at the iQ Menu screen 1 to access the Style Definitions setup screens. This function allows you to identify the style for dispensing material and configure the settings of the style.

NOTE: Before accessing these settings, you need to select if your system is running in Local or Remote control mode. See **Control Modes** on page 41.

NOTE: Through fieldbus only, a style number greater than 16 can be passed over to the E-Flo iQ. However, style definitions and delays must come from the fieldbus.

Style Screen 1 - Style Definition

NOTE: When in Local control mode, you cannot select Source at this screen, but you can still enter Values. The Source fields can be changed in Remote control mode.

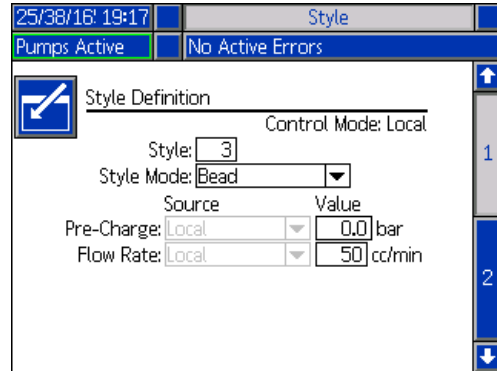

1. Press the  soft key to enter editing mode.
2. Enter a Style identifier from 0-16. This is the designation the system uses for the type of dispensing based on how you define the style here.
3. Bead is automatically selected as the Style Mode.

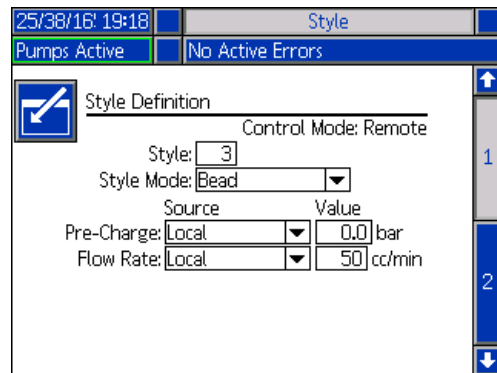

4. From the Source drop-down menus, select the Pre-Charge and Flow Rate as either Local or Fieldbus. When you select Local, enter the appropriate corresponding number in the Value column. A Fieldbus selection does not require a value.

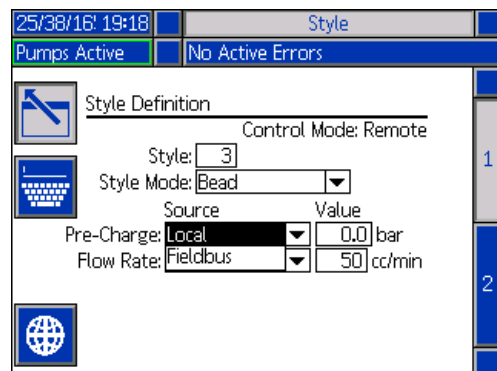

NOTE: The optional Communications Gateway Module (CGM) is required to use fieldbus.

5. Press the  soft key to save your changes and exit editing mode.



Name the Style

You can also name the Style. While still in Style screen

- 1, Press the  soft key to advance to a keyboard screen to create or change the name of the style based on your needs.

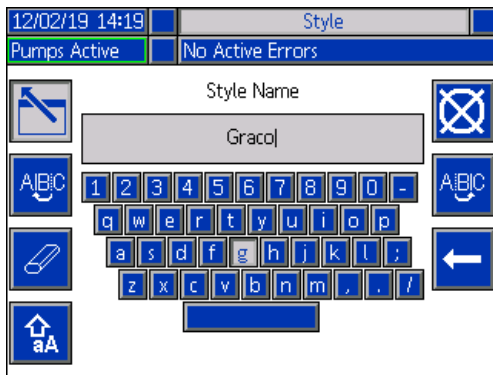
NOTE: The Style identifier is a system requirement. The Style Name option is not required. It is intended as a user-defined description for the application of each dispensing style. An example might be: Trunk Hem. The maximum length is 11 characters.





Use the  and  soft keys to scroll the keyboard to select letters.

The  soft key changes back and forth from lower and upper case.



The  soft key erases everything you have typed.

The  soft key is the backspace to delete one letter at a time.

Press the  soft key to save the name and exit the keyboard screen. Press the  soft key to exit the screen without saving. Both actions return you to Style screen 1.

Apply a Style Setting Globally

While still in Style screen 1, pressing the globalize  soft key applies a style setting across all of the styles. A message will appear prior to completing the change.

Press the  soft key to complete applying the selected parameter. Press the  soft key to cancel the globalization.

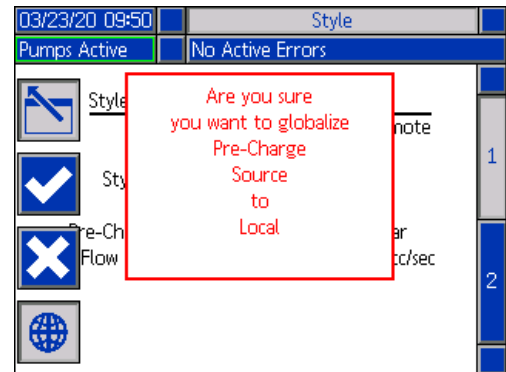

Style Screen 2 - Delays

Use the ADM Directional Keypad (CH) to navigate to Style screen 2.

This screen allows the user to define the delay settings for a style.

NOTE: On/Off delay for the Dispense Valve and Motor cannot be defined at the same time. Only the Dispense Valve or Motor can be delayed.

NOTE: When in Local Control mode, Source cannot be selected at this screen, but Values can still be entered. The Source fields can be changed in Remote Control mode.

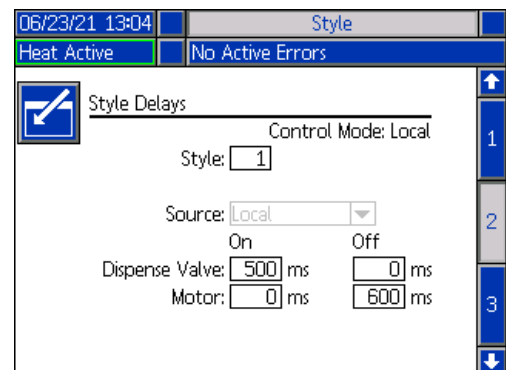

Style Screen 3 - Integration

Use the ADM Directional Keypad (CH) to navigate to Style screen 3.

NOTE: You can only make changes to this screen in Remote mode. In Local mode, the screen appears as shown below.

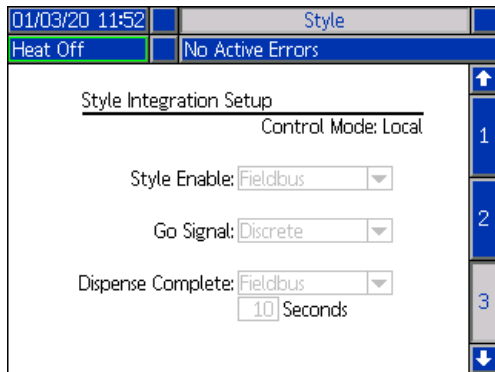

1. In Remote mode, press the  soft key to enter editing mode.

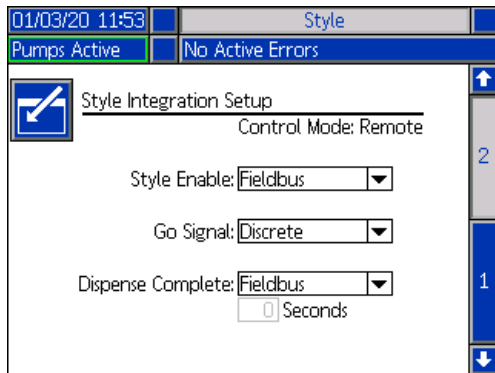

2. Set Style Enable and Go Signal fields to either Discrete or Fieldbus depending on your requirements. It is recommended that you select Discrete for the Go Signal to avoid start and stop delays.
3. Set Dispense Complete to Discrete, Fieldbus, or Timer. If you select Timer, enter the number of seconds for the timer from 0-999.
4. Press the  soft key to save your changes and exit editing mode.

Pump Settings

Press the  soft key at iQ Menu screen 1 to access the Pump setup screens. This function allows you to configure the operating settings for the pump and drum depending on the mode of operation.

Pump Screen 1 - Pump Settings

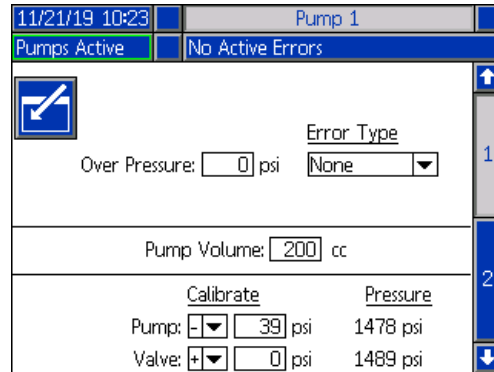

The following description is the same for both Ram and Tandem selections. For Tandem, Pump 1 and Pump 2 are shown in the Menu Bar. Use the ADM Directional Keypad to select each pump for configuration. The Tandem screen is shown below.

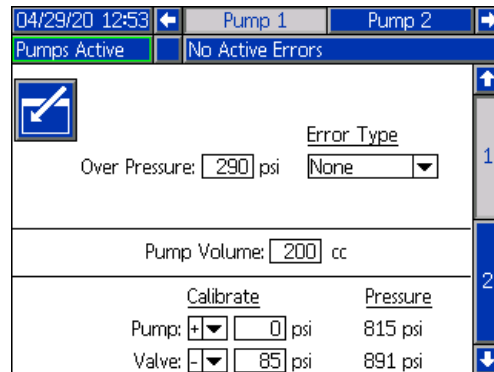

NOTE: in Tandem systems, it is recommended that both pumps should be configured with identical pump settings.

Follow these steps to configure the operating settings for each pump in a Tandem system or a single pump in a Ram system.

1. Press the  soft key to enter editing mode.
2. Configure the Over Pressure setting by entering a pressure limit.

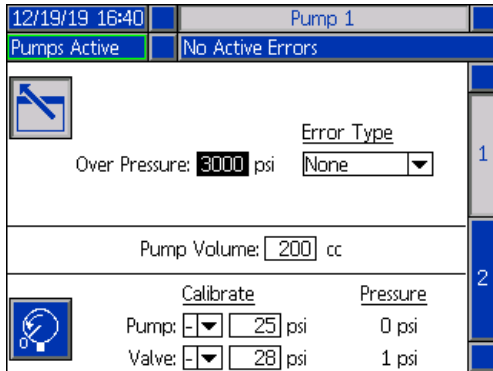

3. Select Alarm, Deviation, or None from the drop down menu for the Error Type.

NOTE: The Over Pressure error will be triggered if the limit is exceeded for 1 second. An Alarm sends an error message and deactivates the system. A Deviation sends an error message but the system continues to operate.



4. The Pump Volume shows the pump size in cc and can be changed in editing mode if needed.

NOTE: Pressure transducers are calibrated at the factory, but calibration may be necessary after extended use. The pump transducer offset and the valve transducer offset are shown in the Calibrate section.

5. Relieve pressure in the system using Valve depressurization. See **Depressurization Mode** on page 42.
6. Press the  soft key to automatically reset the offsets to zero. You can also manually change the values and select minus or plus from the drop down menus as appropriate for the calibration.
7. Press the  soft key to save your changes and exit editing mode.

Pump Screen 2 - Drum Settings

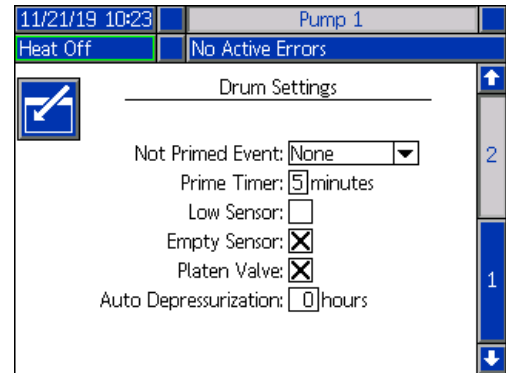

Use the ADM Directional Keypad (CH) to navigate to Pump screen 2.

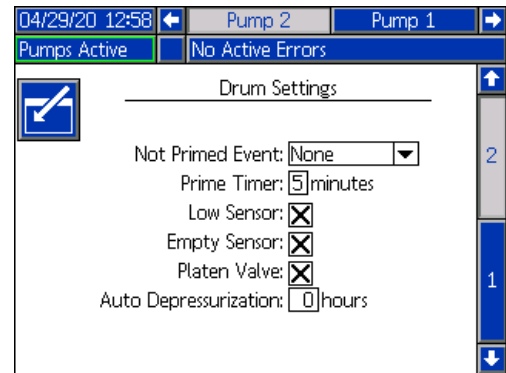

As with the first pump screen, Pump Screen 2 shows both pumps in the Menu Bar in a Tandem system as shown below.



The steps for configuring the settings are the same for both Ram and Tandem.

1. Select the  soft key to enter editing mode.
2. Select the error type from Alarm, Deviation, and None for the Not Primed Event. This is triggered when a drum is replaced and the pump has not yet been primed. If Alarm is selected, the pump must be primed after replacing a drum and before returning to normal operation.
3. Enter the length of the pump Prime Timer between 1 and 9 minutes. Five minutes is the default value. See **Priming Mode** on page 42.
4. By default, the Low Sensor box is unchecked (disabled). Press the  key to enable the drum low deviation.

- By default, the Empty Sensor box is checked (enabled). Press the  key to disable the drum empty alarm if needed.

NOTE: The Low Sensor and Empty Sensor errors are triggered 3 seconds after reaching a critical level.

- Press the  key to enable the Platen Valve setting. This must be enabled to be able to change flow rates between dispenses and to allow platen depressurization. This setting only applies to an E-Flo iQ system that has a Platen Valve installed.
- Auto Depressurization allows the platen valve to open and depressurize the system back to the platen based on this setting. Enter a value between 1 and 24 hours.

NOTE: The Platen Valve must be enabled on the screen to trigger Auto Depressurization. If heat is installed, it places the system into setback. A zero value in the field disables this feature.

- Press the  soft key to save your changes and exit editing mode.

Heat Settings

Press the  soft key at the iQ Menu screen 1 to access the Heat setup screens. These screens allow you to configure the operating settings for the Heat function.

NOTE: Heat must be selected at the System Setup screen for these selections to be available. See the **System Setup Screen** on page 23.

Heat Setup Screen 1

01/08/20 09:08		Heat 1	
Heat Off		No Active Errors	
Zone Type		°C	°F
1-1:	Hose	40	25
1-2:	Valve	40	25
2-3:	Hose	40	25
2-4:	Manifold	40	25
3-5:	Hose	40	25
3-6:	Manifold	40	25
4-7:	Hose	40	25
4-8:	Pump	40	25
5-9:	Platen	38	25

NOTE: For Tandem systems, read this section first, then refer to **Tandem Heat Setup Screen 1** on page 29.

The heat zone number in the first column corresponds to the connector and heat zone on the Automatic Multi-Zone (AMZ) heat control. For example, heat zone number 4-7 corresponds to connector 4 and heat zone 7. For information about the AMZ, refer to the E-Flo iQ Supply Systems, Installation-Parts manual. See **Related Manuals** on page 3.

- Press the  soft key to enter editing mode.
- The Zone Type column refers to the system component that the zone is heating. Select a zone type from the drop down menu for each zone. The options available in the drop down menu are:
 - Hose
 - Valve
 - Manifold
 - PGM (Precision Gear Motor)
 - Flowmeter
 - Press Reg (Pressure Regulator)
 - Other

NOTE: The correct zone type has to be selected for the zone to properly heat. If an incorrect zone type is selected, errors, overshoots, and long heat up times can occur.

01/08/20 09:08		Heat 1	
Heat Off		No Active Errors	
Zone Type		°C	°F
1-1:	Hose	40	25
1-2:	Valve	40	25
2-3:	Manifold	40	25
2-4:	PGM	40	25
3-5:	Flowmeter	40	25
3-6:	Press Reg	40	25
4-7:	Other	40	25
4-8:	Hose	40	25
4-9:	Pump	40	25
5-9:	Platen	38	25

NOTE: There are two other zone types: platen and pump. The zones for these are always 4-8 and 5-9, respectively, as shown above.

- Enter a temperature for the zone setpoint temperature () column. This is the setpoint that the zone heats to when the heat is turned on. The temperature units can be changed from °C to °F in the Advanced settings screens. See **Advanced Setup Screen 2** on page 33.

- Enter a temperature for the zone setback temperature (°C) column. This is the setback that the zone goes to when the heat is in setback. The temperature units can be changed from °C to °F in the Advanced settings screens. See **Advanced Setup Screen 2** on page 33.

NOTE: If you change a setpoint temperature to a value below the current setback temperature, that value becomes the new setback temperature. If you increase a setback temperature to a value above the current setpoint temperature, that value becomes the new setpoint temperature.

- The column on the right side of the zone setback temperature column is for enabling the zone. Use the  key to enable zones.

NOTE: When enabled, the zone will be displayed on the Heat Run screen. When the box is disabled, the zone will not be displayed on the Heat Run screen and the errors for that zone will be ignored. See **Heat Run Screen** on page 44.



- Press the  soft key to save your changes and exit editing mode.

Apply a Heat Setting Globally

While still in Heat Setup screen 1, press the globalize

 soft key to apply a setpoint or setback heat setting across all of the heat zones.

A message will appear prior to completing the change.

Press the  soft key to complete applying the selected parameter. Press the  soft key to cancel the globalization.

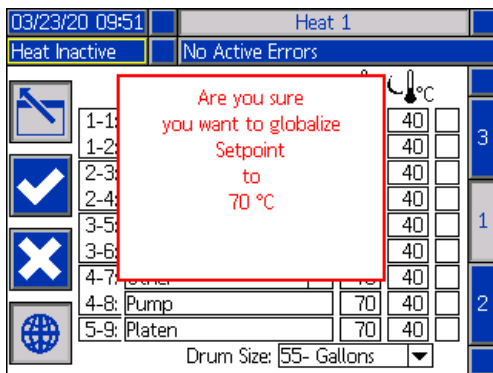

Tandem Heat Setup Screen 1

Read all of **Heat Setup Screen 1** starting on page 28 before reading this section.

The Heat Setup screens for Ram and Tandem are the same in appearance except Tandem has an additional column to the right for the second pump.

One of the advantages of a Tandem system is continuous operation if a pump needs to be shut down for any reason, such as changing a drum of material. In a heated system, it is equally important to maintain heat for the entire system when one of the pumps is shut down.

NOTE: Heated systems have a red and black Power Junction Box Switch (AK) that removes power to everything EXCEPT heat on the ram supply unit. This allows a ram supply unit to continue to heat the system with the power to the ram turned off. See **Power Disconnect** on page 14 for more information.

The Tandem Heat setup screen 1 allows you configure how you want heat to be controlled for the entire system.

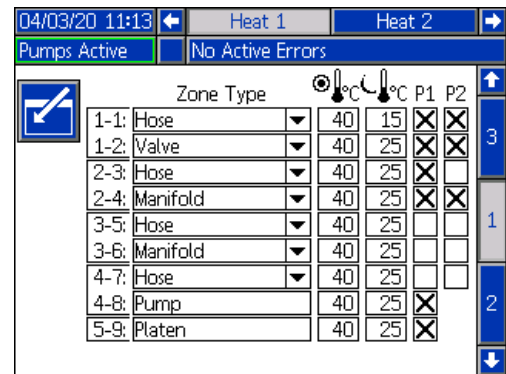



Heat 1 in the Menu Bar is for the Heat Control Box (AX) on the Pump 1 ram and Heat 2 is for the Heat Control Box (AX) on the Pump 2 ram. The heat control box on each ram controls heat to its pump, platen, and the hose that runs from the pump to the Ball Valve (S) on the Tandem Block (R).



Since all components from the Tandem Block R) to the Dispense Valve (B) are shared by both pumps and need to be heated continuously while the system is in operation, you can designate one pump to control the shared components at this screen.

NOTE: The cables for heat from the shared components must be connected to the Heat Control Box (AX) on the designated pump.

In this example, the heat control box on Pump 1 (P1) is the one selected to heat the shared components running from the Tandem Block (R) to the Dispense Valve (B).

1. Press the  soft key to enter editing mode.
2. Configure your Zone Type and setpoint and setback temperatures as described in **Heat Setup Screen 1** on page 28.
3. Use the  key to enable the zones under P1 that will control the heat for the entire system.

NOTE: Since P1 will be the heat control for the shared components, you need to enable the same zones for P2 while at the Heat 1 screen. This sets P1 to control the heat for its pump, platen, and hose while also controlling the heat for the components that P1 and P2 share.

4. Use the  key to enable the zones under P2 that are enabled under P1.
5. Use the ADM Directional Keypad (CH) to move to Heat 2 in the Menu Bar.
6. Use the  key to enable only the pump and platen zones and the zone for the hose that runs from the ram supply unit for P2 to the Ball Valve (S) on the Tandem Block (R) since all others are controlled by P1.

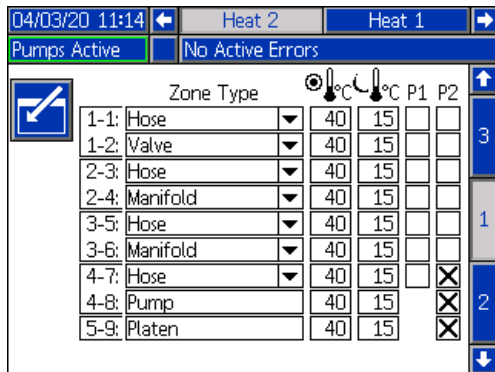

Zone Type	P1	P2
1-1: Hose		
1-2: Valve		
2-3: Hose		
2-4: Manifold		
3-5: Hose		
3-6: Manifold		
4-7: Hose	X	
4-8: Pump	X	X
5-9: Platen	X	X

7. Press the  soft key to save your changes and exit editing mode.

Heat Setup Screen 2 - Heat Soak

Use the ADM Directional Keypad (CH) to navigate to Heat screen 2. This screen is the same for Ram and Tandem except for the additional Heat 2 selection in the Menu Bar. Make sure you configure heat soak time for both Heat 1 and Heat 2 in a Tandem system.

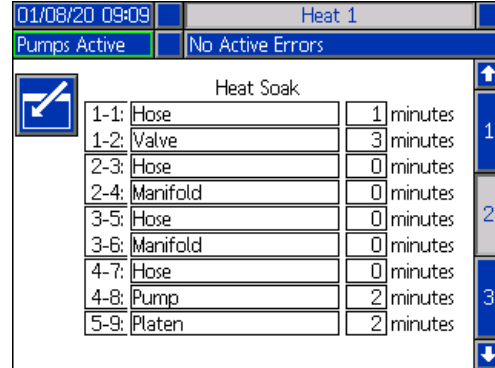

Zone Type	Soak Time (minutes)
1-1: Hose	1
1-2: Valve	3
2-3: Hose	0
2-4: Manifold	0
3-5: Hose	0
3-6: Manifold	0
4-7: Hose	0
4-8: Pump	2
5-9: Platen	2

Press the  soft key to enter editing mode.

The heat soak time in the far right column is the amount of additional time that the heat zone needs to ensure that the material is heated evenly throughout after the zone is up to temperature. Enter a time in minutes.

NOTE: Three minutes is the minimum amount of heat soak time needed to make sure that the dispense valve is completely up to temperature.

The Zone Types can only be changed at the Heat Setup screen 1. See **Heat Setup Screen 1** on page 28.

Press the  soft key to save your changes and exit this screen.

Heat Setup Screen 3

Use the ADM Directional Keypad (CH) to navigate to Heat screen 3. The Tandem screen is shown below. The Ram screen is identical except for only having Heat 1 in the Menu Bar. Make sure you configure these settings for both Heat 1 and Heat 2 in a Tandem system.

06/17/21 06:48		Heat 1			
Heat Active		No Active Errors			
Units: °C		+	+	-	-
1-1:	Hose	25	15	15	25
1-2:	Valve	25	15	15	25
2-3:	Hose	25	15	15	25
2-4:	Manifold	25	15	15	25
3-5:	Hose	25	15	15	25
3-6:	Manifold	25	15	15	25
4-7:	Hose	25	15	15	25
4-8:	Pump	25	15	15	25
5-9:	Platen	25	15	15	25

1. Press the  soft key to enter editing mode.
2. The default values are 15 for deviations and 25 for alarms. You can enter other temperature values for each of the nine zones. Set the variance in degrees allowed from a zone temperature setting before a deviation and alarm is triggered.

For example, if the zone temperature is set at 50 degrees and you set +15 degrees for a High Deviation and +25 degrees for a High Alarm, the deviation will occur when the temperature reaches 65 (50 +15) and the alarm will occur when it reaches 75 (50 + 25).

The same applies to the Low Alarm and Low Deviation settings. In the same example at 50 degrees with a Low Deviation of -15 and a Low Alarm of -25, the deviation will occur when the temperature reaches 35 (50-15) and the alarm will occur when it reaches 25 (50-25).

NOTE: The red bell represents the alarm, the white bell represents the deviation, and the +/- represents high and low.

3. Press the  soft key to save your changes and exit this screen.

Heat Setup Screen 4

Use the ADM Directional Keypad (CH) to navigate to Heat screen 4. The Tandem screen is shown below. The Ram screen is identical except for only having Heat 1 in the Menu Bar. Make sure you configure these settings for both Heat 1 and Heat 2 in a Tandem system.

06/17/21 06:48		Heat 1			
Heat Active		No Active Errors			
		Heat Idle Timeout: <input type="text" value="0"/> hours			
		Heat Rate Option: <input type="text" value="Normal"/>			
		Drum Size: <input type="text" value="20 Liters"/>			

1. Press the  soft key to enter editing mode.
2. The Heat Idle Timeout feature provides the capability to deactivate heat after the pump has not moved for a selected number of hours. Enter the number of hours in the box provided.
3. Select a Heat Rate Option from the drop down menu. The available options are slow, normal, and fast. The heat rate controls how fast the material is heated. To avoid overshooting material heat, select the appropriate option based on the running temperature.

NOTE: If material heat overshoots on a particular heat rate setting, select a slower heat rate.

Running Temperature	Heat Rate Option
26° C - 40° C	Slow
41° C - 55° C	Normal
56° C - 70° C	Fast

4. The Drum Size at the bottom of the screen shows the size of the drum for that ram supply unit. Select the correct drum size from the two options: 5 Gallon Drum and 55 Gallon Drum. The correct drum size must be selected to properly heat the platen.
5. Press the  soft key to save your changes and exit this screen.

Advanced Setup

Use the ADM directional keypad (BH) to change to iQ

Menu screen 2. Press the  soft key to access the Advanced Setup screens. This function allows you to configure the operating settings for E-Flo iQ system.

Advanced Setup Screen 1

1. Press the  soft key to enter editing mode.
2. Select the Language from the drop down menu. Available languages are English, Spanish, French, German, traditional Chinese, Japanese, Korean, Portuguese, Italian, and Russian.

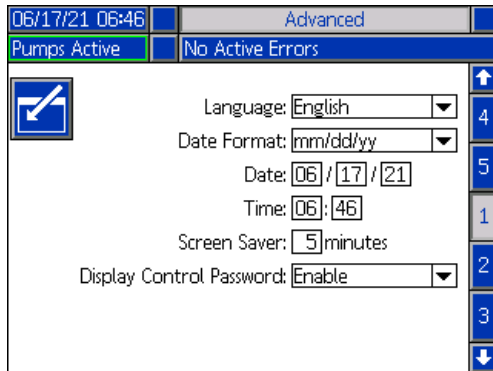

06/17/21 06:46 Advanced

Pumps Active No Active Errors

 Language: English

Date Format: mm/dd/yy

Date: 06 / 17 / 21

Time: 06 : 46

Screen Saver: 5 minutes

Display Control Password: Enable

3. Select a Date Format from the drop down menu. The available formats are mm/dd/yy, dd/mm/yy, and yy/mm/dd.
4. Enter numeric values for the month, day, and two-digit year in the Date field.
5. Enter numeric values in the Time field for the 24-hour clock in hours and minutes.
6. Enter the number of minutes of inactivity before the Screen Saver turns off the screen back-lighting. Enter a 0 to leave it on constantly. Press any key to disable the screen saver.
7. Enabling the Display Control Password feature requires you to enter the password before switching from Remote to Local control mode. See **Control Modes** on page 41. This protects against inadvertently changing out of Remote control mode. If there is not an admin password, this feature will not function even if it is set to Enable or a level has the rights to change the display control.

8. Press the  soft key to save your changes and exit editing mode.

Advanced Setup Screen 2

Use the ADM directional keypad (BH) to navigate to Advanced Screen 2. The parameters on this screen pertain to password levels in the iQ system.

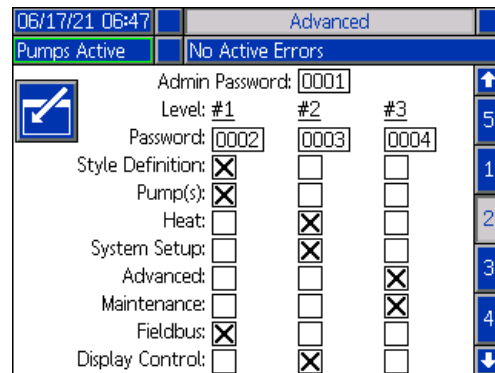

06/17/21 06:47 Advanced

Pumps Active No Active Errors

 Admin Password: 0001

Level: #1 #2 #3

Password: 0002 0003 0004

Style Definition:

Pump(s):

Heat:

System Setup:

Advanced:

Maintenance:

Fieldbus:

Display Control:

1. Press the  soft key to enter editing mode.
2. For the Admin or Level(s) Passwords, enter any numbers from 0001 to 9999. To remove the password, change the password to 0000. This disables the Admin or Level(s) Passwords.
3. Once an Admin Password is defined, the user has the option to define a Level Password. Once a Level Password is defined, the check boxes can be checked to give access to the different menu chapters. If the Display Control Password feature is enabled from Advanced Setup Screen 1, access can be granted to the different levels. The level password can switch the display control from Remote to Local mode. See **Control Modes** on page 41. This protects against inadvertently changing out of Remote Control mode.

NOTE: There must be an Admin Password in order to set up Level Passwords. If the Admin Password is disabled (0000), all passwords are disabled regardless of the Level Passwords.

NOTE: The Admin Password has access to all menu chapters.



NOTE: When the check box is checked, the Level Password has access to that information. If the check box is unchecked, the Level Password will not have access to that information.

NOTE: When a Level Password is entered correctly, the ADM will place an even into the event log of the access level granted.

Advanced Setup Screen 3

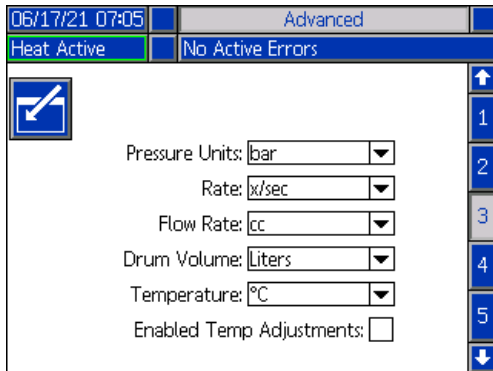
Use the ADM directional keypad (BH) to navigate to Advanced Screen 3. This screen allows you to select units of measurement, rates, and the type of temperature scale to use for the operation of your system.







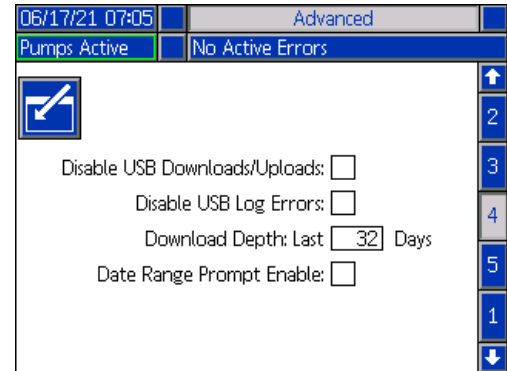

1. Press the  soft key to enter editing mode.
2. Select between psi, bar, and MPa for the Pressure Units.
3. Select the Rate between x/min and x/sec.
4. Select the Flow Rate from cc, gal(US), gal(UK), oz(US), oz(UK), liters, or cycles.
5. Select the Drum Volume from cc, gal(US), gal(UK), oz(US), oz(UK), liters, or cycles.
6. Select the Temperature between °C and °F.
7. For Enabled Temp Adjustments, use the  key to select to Enable or Disable temperature adjustments. Enabling this feature allows you to change temperature setpoints and setbacks through the Heat Run screen. See **Heat Run Screen** on page 44.
8. Press the  soft key to save your changes and exit editing mode.

Advanced Setup Screen 4

Use the ADM Directional Keypad (CH) to navigate to Advanced Screen 4. The parameters on this screen pertain to USB downloads.



1. Press the  soft key to enter editing mode.
2. USB downloads automatically begin when a USB drive is inserted. Use the  key to disable this feature in the Disable USB Downloads/Uploads box.
3. If you do not want USB log errors to be generated on the ADM, use the  key to disable this feature in the Disable USB Log Errors box.
4. For the Download Depth: Last feature, set the desired download depth using the keypad and  key to enter the desired number of days. This specifies how many days worth of pump data will be kept in the USB logs. Once the logs fill up, the oldest recording will be overwritten.
5. To enable a time frame range of data to download upon insertion of a USB drive, use the  key in the Data Range Prompt Enable box.
6. Press the  soft key to save your changes and exit editing mode.

Advanced Setup Screen 5

Use the ADM Directional Keypad (CH) to navigate to Advanced Screen 5.

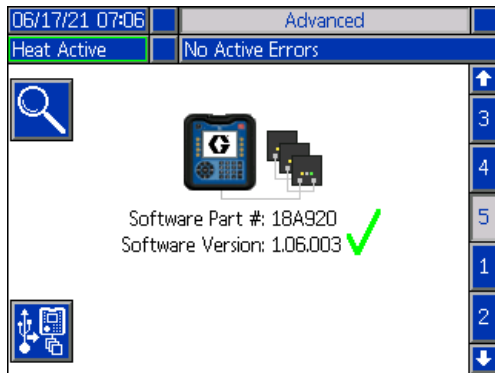

This screen can be used to view the version of software used in the system. Additionally, this screen is used to update the system software using a USB drive with the latest software and a Graco black token. The latest software is provided on Help.graco.com.

Refer to the ADM Token In-System Programming manual for a detailed description of this screen. See **Related Manuals** on page 3.

Connect Light Tower Assembly

1. Order the 255468 Light Tower Accessory as a diagnostic indicator for the E-Flo iQ System.
2. Connect the cable from the light tower to the digital I/O port (CS) on the ADM (AF).

Signal	Description
Off	System is not active
Green Only On	System is active and no errors are present
Blinking Green	Heat is warming up
Yellow On	An advisory exists
Blinking Yellow	A deviation exists
Red solid	The system is shut down due to an alarm occurring

NOTE: See **Troubleshooting** on page 54 for error definitions.

Startup

Letters in parenthesis are used in this section for reference to callouts in the **Component Identification** section starting on page 11.

Flush the Pump

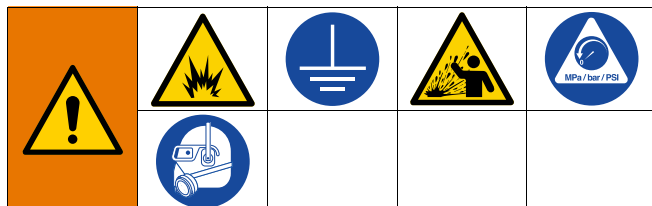

To avoid fire and explosion, always ground the equipment and the waste container. To avoid static sparking and injury from splashing, always flush at the lowest possible pressure.

NOTE: Pumps (AC) are tested with lightweight oil, which is left in to protect the Pump parts. If the material you are using may be contaminated by the oil, flush it out with a compatible solvent before using the Pump (AC).

Always flush at the lowest pressure possible. Check connectors for leaks and tighten as necessary. Flush with a fluid that is compatible with the material being dispensed and the equipment wetted parts.

NOTE: Check with your material manufacturer or supplier for recommended flushing fluids and flushing frequency.

NOTICE





To prevent damage to the pump from rust, never leave water or water-based fluid in a carbon steel pump overnight. If you are pumping a water-based fluid, flush with water first. Then flush with a rust inhibitor, such as mineral spirits. Relieve pressure, but leave the rust inhibitor in the pump to protect parts from corrosion.

For information about Priming the system, refer to **Priming Mode** on page 42.

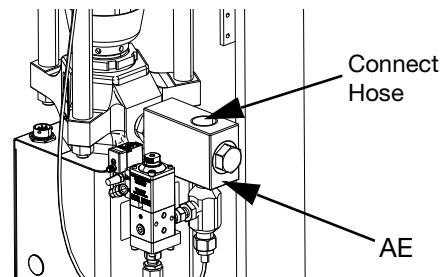
1. Follow the **Pressure Relief Procedure** on page 48.
2. Place a pail of compatible solvent in the Ram (AA).

3. Connect a hose to the 1 in. npt fitting on the top of the Check Valve Block (AE). Place the other end of the hose into a grounded waste container.



4. Turn on the Disconnect Switch (AZ). If using a heated system, also turn on the Power Junction Box switch (AK).
5. Press the Startup button (CA) on the ADM (AF) to enable the system.
6. At the ADM (AF) Run screen, press the soft key next to the  icon to enter editing mode.
7. Press the  soft key to enter the pump priming mode. Two fields appear on the screen next to the pump: target pressure (top) and target flow (bottom).
8. Enter 100 psi (0.7 MPa, 7 bar) as the target pressure and enter 25 cc/min as the target flow.
9. Press the  soft key to initiate the Pump (AC) and start flushing the system. This loads the solvent into the Pump (AC).
10. Adjust pressure as necessary and flush the system until clear solvent flows from the hose.
11. Press the  soft key to stop the Pump (AC).
12. Press the  soft key to exit editing mode.
13. Follow the **Pressure Relief Procedure** on page 48.
14. Remove the solvent pail from the Ram (AA).
15. Repeat steps 1 through 14 for the second pump in a Tandem system.

Load Material

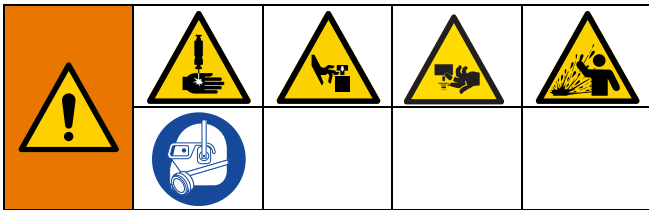

The following steps are required when you are loading material in the system for the first time. This procedure should be performed after the E-Flo iQ system is installed, flushed, and ready for operation. Refer to the E-Flo iQ Supply System Installation-Parts manual for installation. See **Related Manuals** on page 3.

For additional information about the E-Flo iQ Run screens, including priming and depressurization, see **Operation** on page 39.

NOTE: For an E-Flo iQ system with a Platen Valve (AY) installed, you need to ensure that the Platen Valve setting is enabled in the Pump Settings on the ADM before starting this procedure. See **Pump Screen 2 - Drum Settings** on page 27.

NOTE: For Tandem systems, complete all steps in the following sections on both ram supply units before performing the steps in **Load the Hose and Dispense Valve**:

- **Prepare the Pump**
- **Load the Platen and Platen Valve**
- **Load the Pump**
- **Load the Platen Valve and Recirculation Hose**

Prepare the Pump

1. For Tandem Systems, ensure the Ball Valves (S) on the Tandem Block (R) are closed.
2. Turn on the Disconnect Switch (AZ). If using a heated system, also turn on the Power Junction Box switch (AK).
3. Open the Main Air Slider Valve (BA) on the Integrated Air Control and set the Ram Air Regulator (BB) to 40 psi (.20 MPa, 2.0 bar).
4. Move the Ram Director Valve (BC) up to raise the Ram (AA) to its full height.
5. Set the Ram Director Valve (BC) to neutral (horizontal position).
4. Replace the Platen Bleed Stick that was removed in

6. Lubricate the Platen Wiper with grease or another lubricant compatible with the material being loaded.
7. Place a full pail or drum of material on the Ram (AA) base and center it under the Platen (AD). Then remove the drum cover and smooth the surface of the material with a straightedge.
8. To prevent air from being trapped under the Platen (AD), scoop fluid from the center of the pail/drum to the sides to make the surface concave.
9. Adjust the pail/drum to make sure it is aligned with the Platen (AD).
10. Remove the Platen Bleed Stick to open the Platen Bleed Port (AH).

NOTE: If a Platen Valve (AY) is installed on the system, do not connect the Recirculation Hose (ZB) to the Platen Valve Port until you have completed loading material through the system.

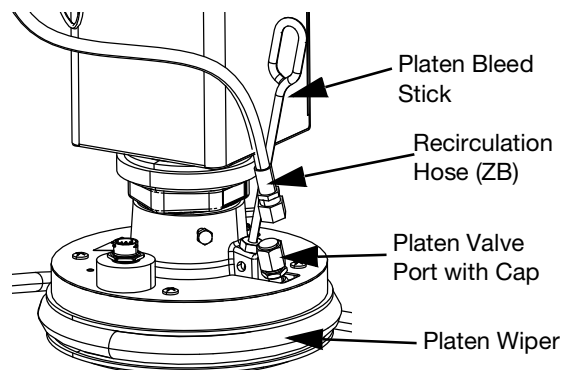

11. With your hands away from the pail/drum and the Platen (AD), move the Ram Director Valve (BC) down to lower the Ram (AA) until the Platen (AD) rests on the lip of the pail/drum.
12. Return the Ram Director Valve (BC) to the neutral position.

Load the Platen and Platen Valve

1. For Tandem systems, ensure the Ball Valves (S) on the Tandem Block (R) are closed.
 2. Move the Ram Director Valve (BC) down to lower the ram until material appears at the Platen Bleed Port (AH).
 3. Return the Ram Director Valve (BC) to the neutral position.
- step 8 in **Prepare the Pump**.

- If a Platen Valve (AY) is installed on the system, remove the cap from the Platen Valve Port located on the platen.
- Move the Ram Director Valve (BC) down to lower the ram again until material appears the Platen Valve Port.
- Return the Ram Director Valve (BC) to the neutral position.
- Replace the Platen Valve Port cap.



Load the Pump

- For Tandem systems, ensure the Ball Valves (S) on the Tandem Block (R) are closed.
- Move the Ram Director Valve (BC) down to lower the Ram (AA).
- At the ADM (AF), press the  soft key to enter the pump priming mode. Two fields appear on the screen next to the pump: target pressure (top) and target flow (bottom).
- Enter 100 psi (0.7 MPa, 7 bar) as the target pressure and enter 25 cc/min as the target flow.

NOTE: Loading the material at the low pressure and flow rate in step 3 keeps the Pump (AC) from cavitating, since there is no material loaded in the Pump (AC).





NOTE: Priming mode has a timer that is shown to the left of the priming mode icon and counts down when the priming starts. The default is 5 minutes. If time expires before you are done loading material to the

system, press the  soft key to restart priming mode. Your target pressure and flow settings remain the same.

- Open the Pump Bleed Valve (AM) and place a waste container below it to catch material.
- Press the  soft key to start the Pump (AC).
- Increase pressure and flow rates on the screen as necessary to fill the Pump (AC) with material.
- When a steady stream of material with no air comes out of the Pump Bleed Valve (AM), close the valve.
- Press the  soft key to stop the Pump (AC).

Load the Platen Valve and Recirculation Hose

NOTE: The following steps only apply to systems that include the Platen Valve (AY). For systems without a Platen Valve, go to step 1 in **Load the Hose and Valve**.

- For Tandem systems, ensure the Ball Valves (S) on the Tandem Block (R) are closed.
- Place the Recirculation Hose (ZB) into a waste container.
- While still in pump priming mode and with the target pressure still set at 100 psi (0.7 MPa, 7 bar) and the target flow at 25 cc/min, press the  soft key to enter the platen depressurization mode.
- Press the  soft key to start the Pump (AC).
- Increase pressure and flow rates on the screen as necessary.
- Run the Pump (AC) until a steady stream with no air flows out of the Recirculation Hose.
- Press the  soft key to stop the Pump (AC).
- Press the  soft key to exit the platen depressurization mode.
- Move the Ram Director Valve (BC) to the neutral position.
- Remove the cap from the Platen Valve Port.
- Install the Recirculation Hose (ZB) to the Platen Valve Port and tighten until secure.

NOTE: It is important to load the Platen Valve (AY) and Recirculation Hose (ZB) with material before connecting it to the Platen Valve Port to ensure no air is introduced into the material. Failure to follow these steps could cause air pockets in the material.





Load the Hose and Dispense Valve

NOTE: For Tandem systems, ensure that the previous four sections are completed for both ram supply units before performing these steps.

- On a Tandem system, open the Ball Valves (S) on the Tandem Block (R).
- Place a waste container below the Dispense Valve (A).

Startup



- Ensure all fittings are secure from the Pump (AC) out to the Dispense Valve (A).
- While still in pump priming mode and with the target pressure still set at 100 psi (0.7 MPa, 7 bar) and the target flow at 25 cc/min, press, the  soft key to enter the valve depressurization mode on Pump 1.

- Press the  soft key to start the Pump (AC). This will open the Dispense Valve (A) and allow the pump to run at the set pressure and flow rate.
- Increase pressure and flow targets as necessary until a steady stream with no air flows out of the Dispense Valve (A).
- Press the  soft key to stop the Pump (AC).
- Press the  soft key to exit the valve depressurization mode.
- Press the  soft key to exit priming mode

Tandem Priming when Changing Drums

When priming one ram supply unit of a Tandem system, the other ram does not need to be stopped when you want to change material drums. The other pump can continue running and dispensing material.

NOTE: This can only be performed when the system is in Remote control mode. For priming pumps in Local mode during operation, see **Priming Mode** on page 42.

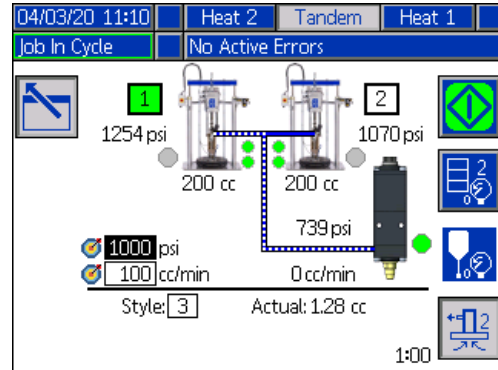

- Press the  soft key to change to Remote control mode. If PLC lockout is active, the inactive pump must be primed through the CGM.
- Adjust the drum to make sure it is aligned with the Platen (AD). See **Prepare the Pump** on page 36.
- Open both Ball Valves (S) on the Tandem Block (R).
- Press the  soft key to switch to the currently operating ram supply unit. The one currently operating is highlighted in green. The Prime icon displays the number of the other ram for priming.
- Press the  soft key to enter the pump priming mode.



- To control the flow of material, set your target pressure and target flow in the fields that are displayed above the line and style number. Ensure that the target prime pressure is at least 100 psi below current system operating pressure, but not less than 400 psi below current operating pressure.
- Open the Pump Relief Valve (ZC) on the ram and place a waste container below it to catch material.
- Press the  soft key to start the priming process.
- Allow adequate amount of time for air to escape the system through the Pump Relief Valve (ZC) while priming. At least 30 seconds with no air pockets is recommended.

NOTE: A timer shows to the left of the priming mode icon and counts down during priming. The default is 5 minutes but can be adjusted between 1 and 9 minutes. See **Pump Screen 2 - Pump Settings** on page 27.

- When a steady stream of material with no air comes out of the Pump Relief Valve (ZC), close the Pump Relief Valve.
- To manually stop the priming process at any time, press the  soft key. If you do not manually stop the process, it will automatically stop when the timer counts down to 0:00.

NOTE: If time has expired, you must press the  soft key again to resume priming. Do not press the  soft key until you have restarted the priming process.

- Press the  soft key to exit the priming mode.

Operation

Ram Run Screen

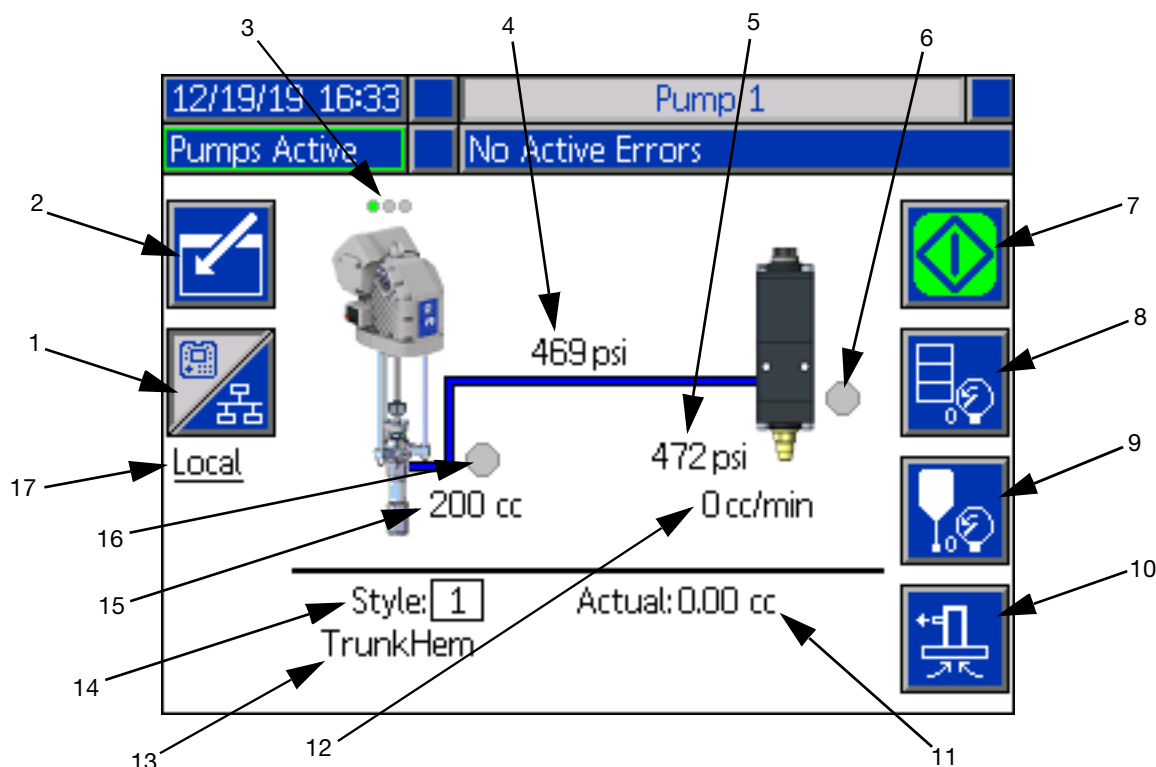

1. Toggles between two modes of control: Local and Remote. See **Control Modes** on page 41.
2. Select to enter or exit the editing mode for the screen.
3. Indicates whether or not an error is active on this pump and the pump status. See **Pump Status** on page 41.
4. Displays the current pump pressure.
5. Displays the current dispense valve pressure.
6. Shows the status of the dispense valve. Green is on, gray is off.
7. Used to run beads manually. This is only available when the system is in Local mode. See **Manual Pump Operation** on page 41.
8. Select to enter or exit drum depressurization mode. See **Depressurization Mode** on page 42.
9. Select to enter or exit dispense valve depressurization mode. See **Depressurization Mode** on page 42.
10. Select to enter or exit priming mode. See **Priming Mode** on page 42.
11. Displays the Actual amount of material.
12. Displays the current flow rate.
13. Displays the name of the style that you have assigned. See **Style Screen 1 - Style Definition** on page 24.
14. Shows the Style identification number that is currently in use. See **Style Screen 1 - Style Definition** on page 24.
15. Displays the size of the pump.
16. Shows the status of the Platen valve used during pump depressurization. Green is on, gray is off.
17. Displays the current mode of control (Local or Remote). See item 1.

NOTE: The pump and material line show animated operation and material flow when dispensing.

Tandem Run Screen

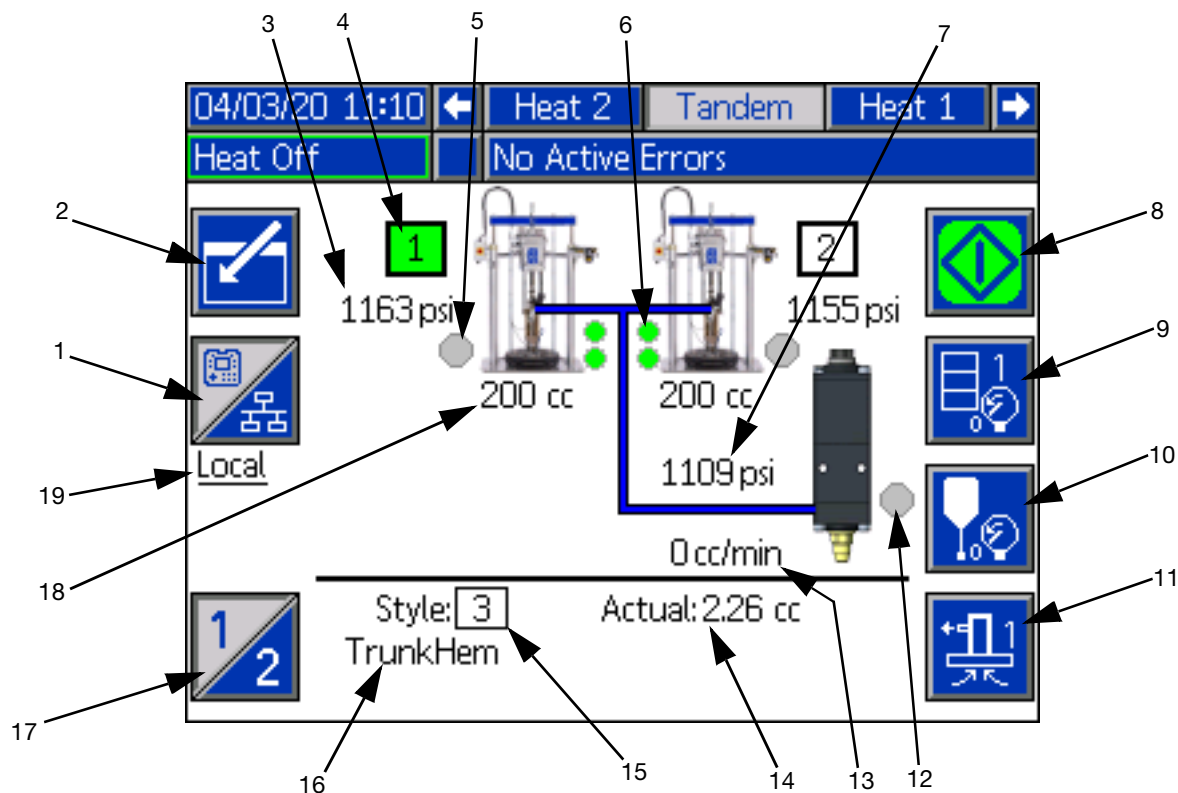



1. Toggles between two modes of control: Local and Remote. See **Control Modes** on page 41.
2. Select to enter or exit the editing mode for the screen.
3. Displays the current pump pressure.
4. Shows the pump currently selected as green.
5. Shows the status of the Platen valve used during pump depressurization. Green is on, gray is off.
6. Low material level and empty material level indicators. Shows as red when low or empty. See **Low Level and Empty Level Indicators** on page 42.
7. Displays the current dispense valve pressure.
8. Used to run beads manually. This is only available when the system is in Local mode. See **Manual Pump Operation** on page 41.
9. Select to enter or exit drum depressurization mode. See **Depressurization Mode** on page 42.
10. Select to enter or exit dispense valve depressurization mode. See **Depressurization Mode** on page 42.
11. Select to enter or exit priming mode. See **Priming Mode** on page 42.
12. Shows the status of the dispense valve. Green is on, gray is off.
13. Displays the current flow rate.
14. Displays the Actual amount of material.
15. Shows the Style identification number that is currently in use. See **Style Screen 1 - Style Definition** on page 24.
16. Displays the name of the style that you have assigned. See **Style Screen 1 - Style Definition** on page 24.
17. Toggles between Pump 1 and Pump 2. See item 4.
18. Displays the size of the pump.
19. Displays the current mode of control (Local or Remote). See item 1.

NOTE: The pump and material line show animated operation and material flow when dispensing.

Control Modes

The E-Flo iQ system can be controlled locally or remotely. Pressing the soft key for this icon toggles back and forth between the two modes. When this icon





 is displayed, the pump is controlled in Local mode

through the display. When this icon  is displayed, the pump is controlled in Remote mode through discrete I/O or fieldbus protocols.

If the system is in Remote mode, the pump is active, and there are no errors, dispensing can be controlled by the Programmable Logic Controller (PLC) or robot through a fieldbus connection. The ADM goes into PLC Lockout during this time. While in PLC lockout, the PLC has complete control. You can change settings if they are not password protected but cannot perform any other functions using the ADM.





Pump Status

Pump Status is for Ram systems only. The three dots located above the pump on the Run Home screen indicate the pump status and whether or not an error is active on the pump. They represent increasing levels of readiness and activity.

From left to right:	
	Pump enabled/disabled (green if enabled, amber if disabled)
	Pump enabled, off, and not moving
	Pump enabled and commanded to drive, but pump is not moving (stalled)
	Pump enabled, commanded to drive and moving

Manual Pump Operation

Use the  soft key to dispense manually. This icon is only available when the ADM is in Local control mode. See **Control Modes** on this page. This icon changes based on the status of the pump.

Icon	Function
	Green: Start the pump
	Inverted Red: Stop the pump
	Red with Border (enabled): Indicates that the pump cannot be started due to an alarm.
	Red with No Border (not enabled): Indicates that the system is not enabled and the pump cannot be started.
	Yellow: Indicates that the pump has an active alarm but still allows the valve and platen to be depressurized. The pump can still be primed only if it is a "pump not primed" alarm.

NOTE: Customer Go Signal can be used in local control mode. See page 68.

On Tandem systems, press the  soft key to switch to Pump 1 or Pump 2.

When you press the  soft key, the Run screen disables other icons on the screen. This is indicated by removing the borders of the icons as shown below.

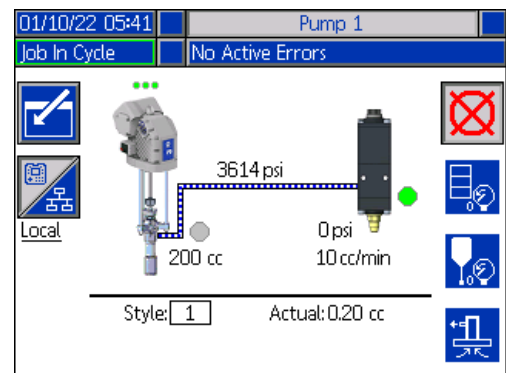



While the pump is performing the bead dispense, the pump and material line are animated.

NOTE: You need to manually stop a bead dispense by pressing the  soft key.





Depressurization Mode

The drum platen and the dispensing valve can be depressurized from the Run screen in Local control

mode. Press the  soft key on a Tandem system to switch between Pump 1 and Pump 2.

1. On a Tandem system, open the Ball Valves (S) on the Tandem Block (R).
2. Press the  soft key to enter the Platen depressurization mode or the  soft key to enter the Valve depressurization mode.

NOTE: The depressurization process does not automatically stop. You need to manually stop depressurization as described below.

3. Press the  soft key to start the depressurization process and  to stop it.
4. Press the  soft key for the platen or the  soft key for the valve to exit the depressurization mode.

Priming Mode



The pump can be primed from the Run screen in Local control mode during operation. If the pump is being controlled by PLC Lockout, priming must be done through CGM. See the **Prime Diagram** on page 92.

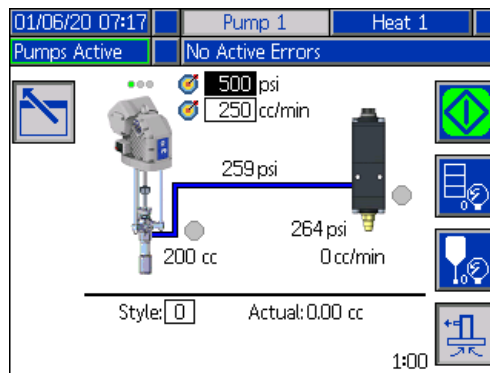

The steps are the same for the Ram and Tandem systems. On Tandem systems, press the  soft key, if needed, to switch between Pump 1 and Pump 2.

NOTE: You are able to depressurize the platen and valve on a pump while in priming mode.

1. On a Tandem system, open the Ball Valves (S) on the Tandem Block (R).
1. Press the  soft key to enter the pump priming mode.
2. To control the flow of material, set your target pressure and target flow in the fields that are displayed above and to the right of the pump.



3. Press the  soft key to start the priming process.
4. A timer is shown to the left of the priming mode icon and counts down when the priming starts. The default is 5 minutes but you can adjust the timer setting to between 1 and 9 minutes. See **Pump Screen 2 - Pump Settings** on page 27.
5. To manually stop the priming process at any time, press the  soft key. If you do not manually stop the process, it will automatically stop when the timer counts down to 0:00.

NOTE: If time has expired, you must press the  soft key again to resume priming. Do not press the  soft key until you have restarted the priming process.

6. Press the  soft key to exit the priming mode.

NOTE: Refer to **Load Material** on page 36 for information about priming and loading material into the pump the first time after installation.

NOTE: Priming does not appear in the Job Log.

Low Level and Empty Level Indicators

The Tandem Run screen has low material level and empty material level indicators. You can enable or disable the sensors for these on **Pump Screen 2 - Drum Settings** on page 27. These monitor the material level in the drums.

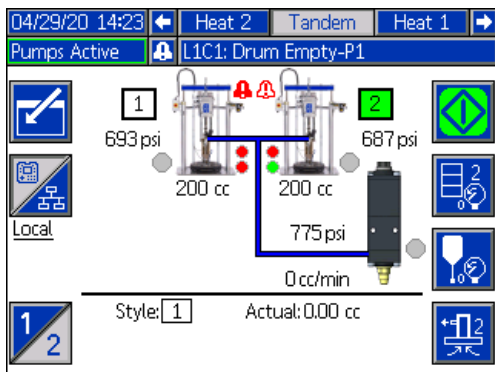

The indicators normally show as green. When a low level sensor on the ram is activated because material in the drum is low, the top indicator for the pump turns red and an error symbol appears next to the pump.

When an empty level sensor is activated on the ram, the bottom indicator for the pump turns red and the error symbol changes to the one selected for the empty level sensor.

In the example above, the low level sensor is set to Deviation and the empty level sensor is set to Alarm to stop operation of the pump.

Run Screen Editing Mode

Press the  soft key to enter editing mode.

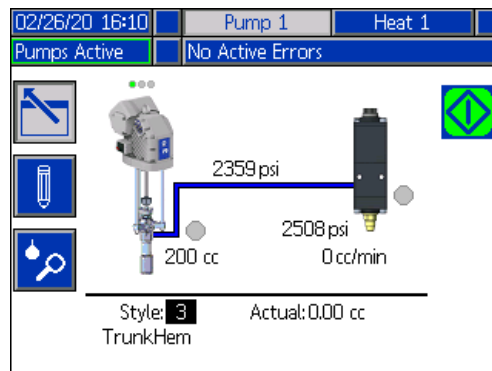

Press the  soft key to access the Style Definitions setup screens. See **Style Definitions** on page 24 for information about this function.

You can change the style identification number without going to the Style Definitions setup screens. Enter the new number using the numeric keypad and confirm it by pressing the  key.

Press the  soft key to access the Job Log. See **Job Log** on page 46 for information.

Press the  soft key to exit editing mode.

Heat Run Screen

When Heat is selected for a pump at the System Setup screen, a Heat Run screen is available. See **System Setup Screen** on page 23. Use the ADM directional keypad (BH) to go to the Heat Run screen.

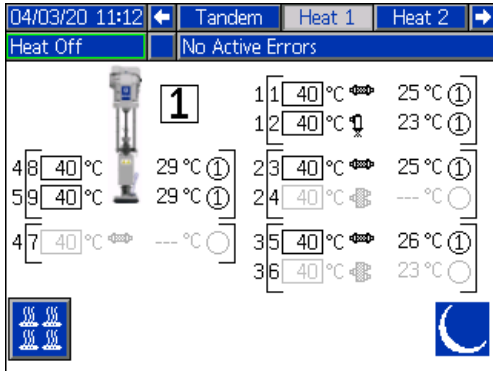

The Ram Heat Run screen is identical to the Tandem Heat Run screen except for the Menu Bar as shown below.

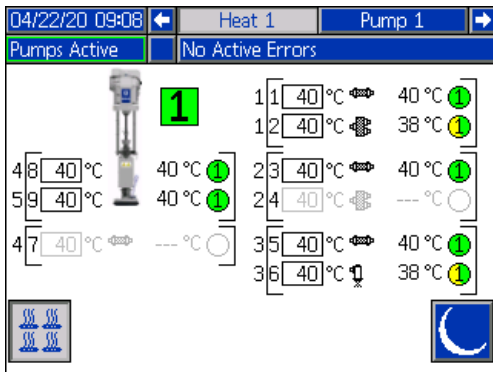

NOTE: The zone must be enabled at the Heat Setup screen 1 to be displayed on the Heat Run screen. See **Heat Settings** on page 28.

The pump heat zones are shown on the left side of the screen and the zones for the other system components are shown on the right. The number in the box next to the pump is the pump number.

For each component, the number outside the left bracket is the connector number. The number just inside the left bracket is the zone number.

The temperature reading inside the box is the zone setpoint/setback temperature. It is the setpoint to which control is heating the zone when the zone is turned on. When the system is placed in setback, the temperature displayed in the box is the setback value.

The temperature units can be changed from °C to °F in the Advanced Settings screens. See **Advanced Setup Screen 2** on page 33.

The zone heat symbols on the right side of the screen correspond to the current type to which the zone is set.

Zone Heat Symbol	
	Hose
	Valve
	Manifold
	PGM
	Flowmeter
	Press Regulator
	Pump
	Platen



The number to the right of the Zone Heat Symbol is the zone's actual temperature. The temperature unit is the same as the zone setpoint/setback temperature unit.

The zone heat state is the circle with a number inside of it next to the temperature unit. There are four different colors used in the indicators for the heat zone.

Color	Description
Green	Heat zone is at temperature.
Yellow	Heat Zone is in setback.
Yellow to Green	Heat zone is warming up or heat zone is heat soaking. It starts as yellow then progresses clockwise to green as it warms up. The pump number also flashes yellow to green during heatsoak.
Green to Red	Heat zone has a deviation/advisory.
Red	Heat zone has an alarm.
White	Heat zone is turned off.

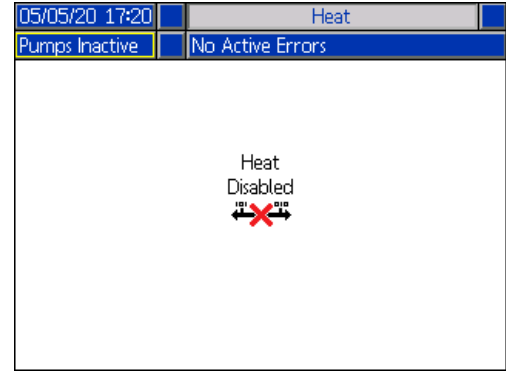
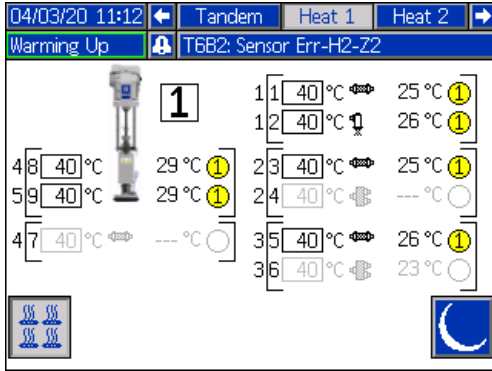
1. Press the soft key to turn the heat zones on and off.



- When the  icon is showing, you can put the system into setback by pressing the  soft key. This places all of the zones displayed on the screen to setback and shows the setback temperature in the zone setpoint/setback temperature box.
- Press the  soft key to take the system out of setback.

See **Heat Settings** on page 28 to enable heat zones.

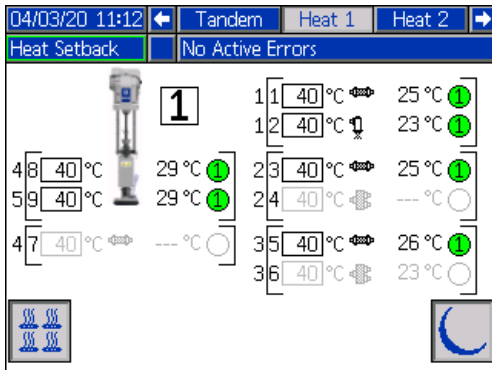

If all of the existing heat zones are disabled, the readings on the Heat Run screen will be gray. If Heat is not enabled at the System Setup screen, the following screen will be displayed when you select the Heat Run screen from the Menu Bar.

Job Log

Access the Job Log screens from the Run Home screen

or iQ Menu screen 1 by pressing the  soft key. The Job Log screen provides detailed information about all of the jobs performed on the system. The jobs are listed chronologically from most recent to oldest.

12/19/19 16:41		Job Log	
Pumps Active		No Active Errors	
Date	Time	Shot	Pump
Pump	Style	Actual	Valve
12/19/19	16:38	--	0 psi
1	1	201.09 cc	68 psi
12/19/19	16:38	--	0 psi
1	1	5.11 cc	70 psi
12/19/19	16:37	--	0 psi
1	1	17.39 cc	77 psi
12/19/19	16:37	--	0 psi
1	1	25.15 cc	94 psi
12/19/19	16:37	--	0 psi
1	1	14.25 cc	108 psi
12/19/19	16:37	--	0 psi
1	1	16.60 cc	142 psi

NOTE: Priming the pump using the  soft key on the Run screen does not appear in the Job Log.

Each job log includes two rows and four columns of information. The cell descriptions are shown at the top of each page under the Menu Bar.

Job Log	
Date	The month, day, and year the job was recorded.
Time	The time the job was completed.
Pump (Pressure)	The pump pressure for the job.
Pump	The pump identification number.
Style	The style identification number that was run in the job.
Actual	How much material the pump dispenses.
Valve (Pressure)	The valve pressure for the job.

NOTE: The pump and valve pressures are recorded at the time of the valve opening.

The Job Log maintains a record of the last 204 jobs that were performed. Use the ADM directional keypad (BH) to scroll through the pages.

Red text on the Job Log screen indicates that a job/style had a changeover during a dispense, meaning that the valve was open when the pump changed directions. These are shown in red to indicate the changeover because the amount that is displayed in the Actual field may vary.

05/01/20 10:43		Job Log	
Heat Soak		No Active Errors	
Date	Time	Shot	Pump
Pump	Style	Actual	Valve
05/01/20	10:38	--	876 psi
1	1	76.43 cc	786 psi
05/01/20	10:35	--	872 psi
1	1	4.32 cc	771 psi
05/01/20	10:35	--	896 psi
1	1	3.64 cc	771 psi
05/01/20	10:34	--	917 psi
1	1	46.17 cc	771 psi
05/01/20	10:33	--	913 psi
1	1	8.96 cc	771 psi
05/01/20	10:33	--	881 psi
1	1	20.63 cc	786 psi

Events and Errors

Events Log Screen

This screen shows the Date, Time, Event Code, and Description of all events that have occurred on the system. There are 20 pages, each holding 10 events. The 200 most recent events are shown.

Use the ADM directional keypad (BH) to scroll through the pages.

11/04/19 16:55		Events	
Pumps Active		No Active Errors	
Date	Time	Code	Description
11/04/19	16:52	ECOX-R	Setup Values Changed
11/04/19	16:50	ECOX-R	Setup Values Changed
11/04/19	16:49	ECOX-R	Setup Values Changed
11/04/19	16:48	EBH1-R	Heat Off-H1
11/04/19	16:48	ECOX-R	Setup Values Changed
11/04/19	16:48	EDT1-R	Heat at Temperature-H1
11/04/19	16:47	EAW1-R	Heat is Warming Up-H1
11/04/19	16:47	EDS1-R	Heat in Setback-H1
11/04/19	16:46	EBH1-R	Heat Off-H1
11/04/19	16:46	ECOX-R	Setup Values Changed

See **Troubleshoot Errors** on page **55** for instructions on viewing event code descriptions.

All events listed on this screen can be downloaded on a USB flash drive. To download logs, see the **Download Procedure** on page **65**.

Errors Log Screen

This screen shows the Date, Time, Error Code, and Description of all errors that have occurred on the system. There are 20 pages, each holding 10 events. The 200 most recent errors are shown.

Use the ADM directional keypad (BH) to scroll through the pages.

11/04/19 16:56		Errors	
Pumps Active		No Active Errors	
Date	Time	Code	Description
10/29/19	15:29	CCG1-A	Fieldbus Comm. Error-P1
10/29/19	15:08	CBD1-A	Comm. Error-P1
10/29/19	14:58	CBD1-A	Comm. Error-P1
10/29/19	14:31	CBD1-A	Comm. Error-P1
10/29/19	13:59	CBD1-A	Comm. Error-P1
10/29/19	13:57	CBD1-A	Comm. Error-P1
10/25/19	09:56	CBD1-A	Comm. Error-P1
10/25/19	09:56	WSUD-A	USB Configuration Error
10/23/19	09:52	CBD1-A	Comm. Error-P1
10/23/19	09:52	WSUD-A	USB Configuration Error

See **Troubleshoot Errors** on page **55** for instructions on viewing error code descriptions.

All errors listed on this screen can be downloaded on a USB flash drive. To download logs, see the **Download Procedure** on page **65**.

Pressure Relief Procedure

Follow the Pressure Relief Procedure whenever you see this symbol.

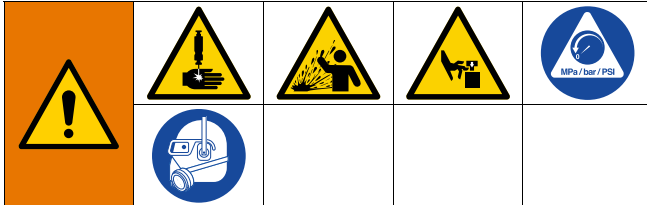

This equipment stays pressurized until pressure is manually relieved. To help prevent serious injury from pressurized fluid, such as skin injection, splashing fluid and moving parts, follow the Pressure Relief Procedure when you stop spraying and before cleaning, checking, or servicing the equipment.

NOTE: The ADM must be in Local control mode to depressurize the system.

NOTE: For iQ Tandem Supply Systems, make sure both Ball Valves (S) on the Tandem Block (R) are open to ensure pressure is fully relieved.

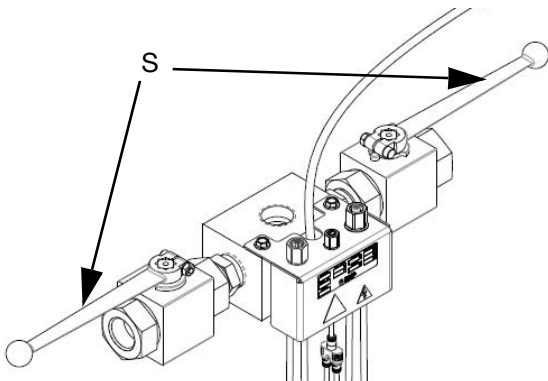

FIG. 7: Tandem Block Ball Valves

NOTE: To relieve pressure for the entire E-Flo iQ Dispense System, follow steps 1 through 12. To relieve pressure for the fluid side only, leaving air on to the ram cylinder follow steps 1 through 9.

1. Ensure the control mode is set to Local. See **Control Modes** on page 41.

- At the ADM (AF) Run screen, press the soft key for Valve Depressurization. Then press the soft key to open the Dispense Valve (A) allowing the system to depressurize.

Single Unit Run Screen

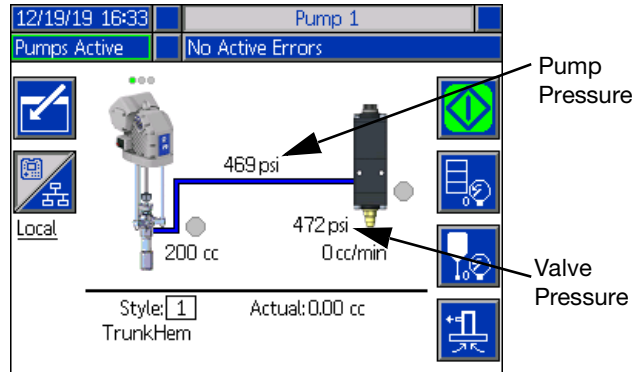

Tandem Unit Run Screen

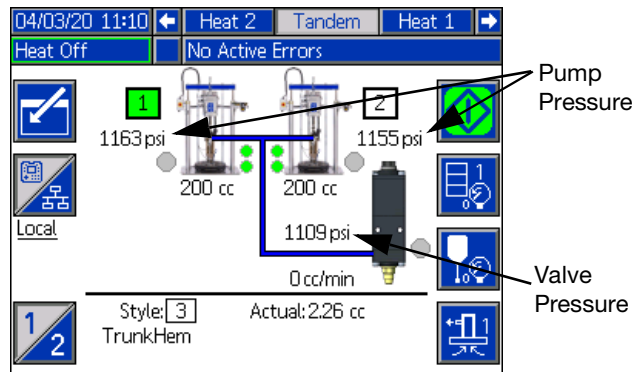

- The current pump pressure and current dispense valve pressure show the progress of the depressurization on the Run screen.
- When all of the pressure has been relieved in the system, press the soft key to close the Dispense Valve (A).
- Press the soft key to exit the valve depressurization mode.

NOTE: If using a Tandem system, perform steps 6 through 12 on both units.

6. If using an ambient system, turn the Disconnect Switch (AZ) OFF. If using a heated system, turn the Power Junction Box Switch (AK) and the Disconnect Switch (AZ) OFF.
7. Open the Pump Bleed Valve (AM). Have a container ready to catch the drainage.
8. Leave the Pump Bleed Valve (AM) open until ready to dispense again.
9. If you suspect the dispense valve is clogged or that pressure has not been fully relieved:
 - a. VERY SLOWLY loosen the hose end coupling to relive pressure gradually.
 - b. Loosen the coupling completely.
 - c. Clear the obstruction in the tip/nozzle of the valve.
10. Close the Main Air Slider Valve (BA).

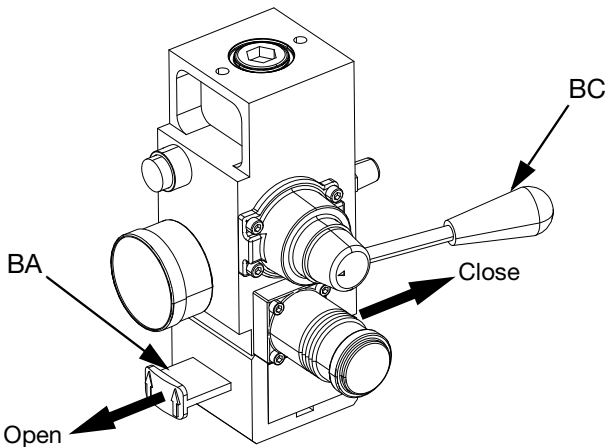

FIG. 8: Air Control for Pressure Relief

11. Set the Ram Director Valve (BC) to DOWN. The Ram (AA) will slowly drop.
12. Once the Ram (AA) is completely down, jog the Ram Director Valve (BC) up and down to bleed air from the Ram (AA) cylinders.

Shutdown the System



NOTICE

To prevent damage to the pump from rust, never leave water or water-based fluid in a carbon steel pump overnight. If you are pumping a water-based fluid, flush with water first. Then flush with a rust inhibitor, such as mineral spirits. Relieve pressure, but leave the rust inhibitor in the pump to protect parts from corrosion.

1. Follow the **Pressure Relief Procedure** on page 48.

NOTE: If using a Tandem system, perform these steps on both units.

2. Set the Ram Director Valve (BC) to DOWN, and lower the Ram (AA) to the desired position for shutdown.
3. Set the Ram Director Valve (BC) to neutral.
4. Stop the Pump at the bottom of the stroke to prevent fluid from drying on the exposed displacement rod and damaging the throat packings. See **Pump Maintenance Screen 1** on page 50 for information about manually moving the pump using the ADM.
5. Always flush the Pump before the fluid dries on the displacement rod. See the E-Flo iQ Supply System Operation manual for steps to flush the pump.



Maintenance

Press the  soft key at iQ Menu screen 2 to access the Maintenance screens. The Maintenance screens are the same for Tandem and Ram except Pump 2 will show in the Menu Bar. Use the ADM's Directional Keypad (CH) to navigate to Pump 2.

Pump Maintenance Screen 1

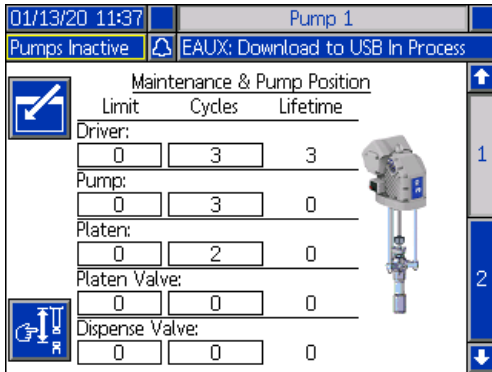
The Maintenance and Pump Position screen allows you to set maintenance parameters and view and change the pump position.



1. Press the  soft key to enter editing mode.
2. For the Driver, Pump, Platen, Platen Valve, and Dispense Valve, you can enter a Limit for the number of cycles that can be run before a message is issued that maintenance is needed. Use the navigation arrows to move between selections and enter the number using the numeric keypad (BJ).
3. To reset the Cycles counter, use the navigation arrows to move to each one you want to reset and press the  soft key.

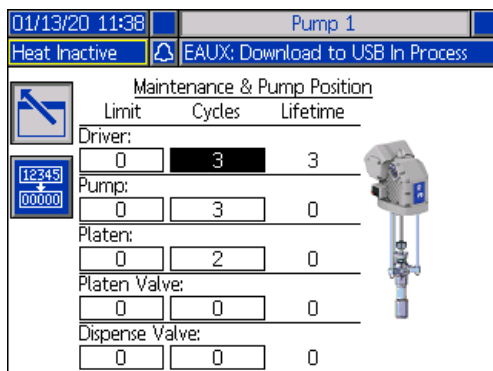

NOTE: Reset the counter after maintenance is completed.

4. Press the  soft key to exit editing mode.

Press the  soft key to enter manual pump movement mode. The arrow keys on the right side of the screen move the pump's driver rod up and down. The driver rod on the picture of the pump will move to represent the action.

NOTE: The arrow keys are only available if the driver is calibrated and not already in use.

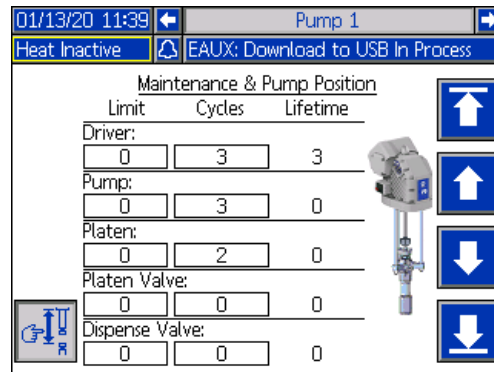

Press and release the  soft key to move the driver rod to the top.

Press and hold the  soft key to move the driver rod up. The driver rod will move up as long as the soft key is held or until it reaches the top.

Press and hold the  soft key to move the driver rod down. The driver rod will move down as long as the soft key is held or until it reaches the bottom.

Press and release the  soft key to move the driver rod to the bottom.



NOTE: A medium force and relatively slow speed is used.

Press the  soft key to exit the manual pump movement mode.

Pump Maintenance Screen 2

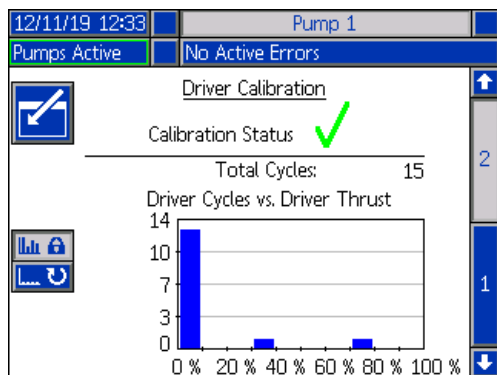
Use the ADM's Directional Keypad (CH) to navigate to screen 2. This screen shows the driver calibration status and the driver usage histogram.



A  indicates that the driver is calibrated and ready to operate. A  indicates the driver must be calibrated before operation.



The histogram represents how hard the driver has been run in its lifetime. Each cycle falls between 0% and 100%. For example, five pump cycles at maximum force would be all the way to the right at 100%. Five pump cycles at minimum force would be all the way to the left at 0%.

Press the  soft key to toggle between the histogram displaying the total lifetime cycles and the cycles since the last reset.

Press the  soft key to enter editing mode.

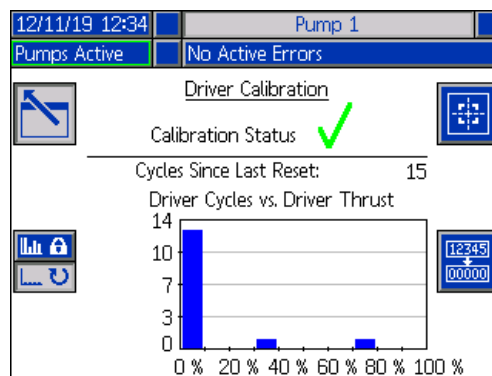
When in editing mode with the Cycles Since Last Reset histogram showing, pressing the  soft key on the right resets the histogram.



Press the  soft key to show the Driver Calibration screen. Press the  soft key to begin driver calibration. Refer to your driver manual for calibration instructions.

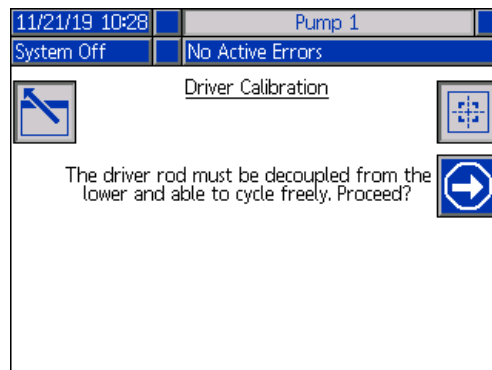

Press the  soft key to exit editing mode.

Diagnostics

Press the  soft key at iQ Menu screen 1 to access the Diagnostics screens. These screens display key parameters that are useful in troubleshooting issues.

These Diagnostics screens are the same for Tandem and Ram except Pump 2 will show in the Menu Bar. Use the ADM's Directional Keypad (CH) to navigate to Pump 2.

Pump Diagnostics Screen

This screen shows the values of the pump parameters. This is for informational purposes. No changes can be made at this screen.

Diagnostics		
Parameter	Value	Units
Motor Temperature	26	°C
IGBT Temperature	28	°C
Bus Voltage	333	V
Motor Current	76	mA
Pump Position	---	in
Pump Direction	↓	

If the Motor Temperature value is too high, it will generate an alarm and shut down the pump.

The IGBT Temperature is the temperature inside the driver casing on the control board. If the value is too high, it will generate an alarm and shut down the pump.

The Bus Voltage is the DC voltage of the driver bus.

The Motor Current is the active current that is being used by the driver.









The pump position is shown in inches.

The Pump Direction arrow indicates the direction that the pump is moving. If the arrow is red, the pump is in a changeover. If the arrow is green, the pump is not in a changeover.

Heat Diagnostics Screen









Use the ADM's Directional Keypad (CH) to navigate to the Heat Diagnostics Screen. This screen displays the current heat state, temperature, current, and duty cycle at which the zone is currently running, along with the heat soak timer and line voltage coming into the AMZ.

This is for informational purposes. No changes can be made at this screen.

Heat Soak		No Active Errors	
Diagnostics			
	39.4 °C	0.5 A	8 %
	38.4 °C	0.3 A	16 %
	39.6 °C	0.6 A	4 %
	39.3 °C	0.5 A	4 %
	39.4 °C	0.0 A	3 %
	---	0.0 A	0 %
	40.0 °C	0.6 A	5 %
	39.9 °C	1.0 A	3 %

Line Voltage:	
1:	244.1 V
2:	245.3 V
3:	12.5 V

The zone heat symbol on this screen corresponds to the current type to which the zone is set.

Zone Heat Symbol	
	Hose
	Valve
	Manifold
	PGM
	Flowmeter
	Press Regulator
	Pump
	Platen

The zone heat state is the circle with two numbers inside of it next to the zone heat symbol. There are four different color indicators for the heat zone.

Color	Description
Green	Heat zone is at temperature or heat zone is in setback.
Yellow	Heat zone is in setback.
Green/Red	Heat zone has a deviation/advisory.
Yellow/Green	Heat zone is in warm up or heat zone is temperature soaking.
Red	Heat zone has an alarm.
White	Heat zone is turned off.

The zone actual temperature is next to the zone heat state and shows the actual temperature of the zone. The temperature units can be changed from °C to °F in the Advanced Settings screens. See **Advanced Setup Screen 2** on page 33.

Continuing to the right on the screen, the current is the actual use of current for the zone. The current is shown in units of Amps (A).

The zone duty cycle is the actual cycle to which the zone is working. The duty cycle is in units of percentage (%) and is shown to the right of the current.

The heat soak countdown timer, which is next the column on the right, shows the remaining time that the zone will be in heat soak.



The Line Voltage at the far right of the screen shows the current system voltages coming into the AMZ.

Pressure Diagnostics Screen

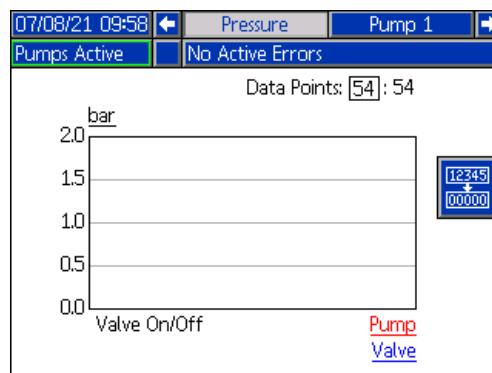
Use the ADM's Directional Keypad (CH) to navigate to the Pressure Diagnostics Screen. This screen shows on-off data points for the Pump pressure (red) and Valve Pressure (blue).



You can display between 2 and 54 data points on the graph.

1. Press the  key at the Data Points box.
2. Use the numeric keypad (BJ) to enter the number of data points you want to view.
3. Press the  key again to confirm.

Pressing the  soft key clears all of the data points from the graph.

Troubleshooting

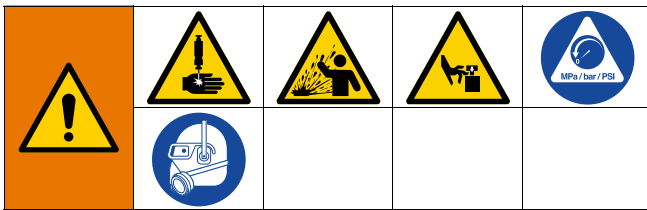

REMOTE SYSTEM ACTIVATION HAZARD
 To avoid injury due to remote machine operation, perform the steps below before troubleshooting. This will prevent commands sent from the fieldbus or display module from actuating the driver/pump.

1. Perform the **Pressure Relief Procedure** on page 48.
2. Turn off the yellow and red Disconnect Switch (AZ). See **Power Disconnect** on page 7.

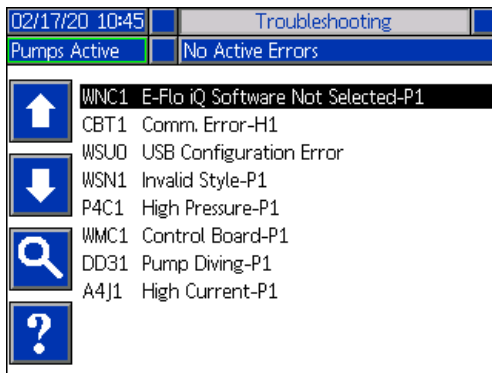

View Errors

Press the  soft key at iQ Menu screen 1 to access the Troubleshooting screen.



This screen shows the list of errors with error codes and descriptions. Use the arrow soft keys to scroll

through the list and select an error. Press the  soft key to advance to the QR Code screen for the selected error. See **Troubleshoot Errors** on this page.

Press the  soft key to advance to a keyboard screen that allows you to search for an error by error code. Type in the error code, then press the  soft key to advance to the QR Code screen.

See **Style Definitions** on page 24 for additional information about using the keyboard.

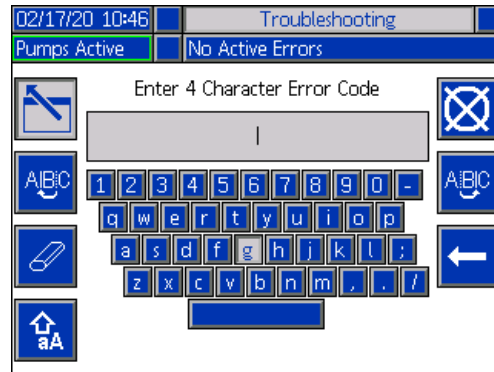



Troubleshoot Errors

When an error occurs, the error information screen displays the active error code and description.

The error code, alarm bell, and active errors will scroll in the status bar. Error codes are stored in the error log and displayed on the Error and Troubleshooting screens on the ADM.

There are three types of errors that can occur. Errors are indicated on the display as well as by the light tower (optional).

Alarms are indicated by . This condition indicates a parameter critical to the process has reached a level requiring the system to stop. The alarm needs to be addressed immediately.

Deviations are indicated by . This condition indicates a parameter critical to the process has reached a level requiring attention, but not sufficient enough to stop the system at this time.

Advisories are indicated by . This condition indicates a parameter that is not immediately critical to the process. The advisory needs attention to prevent more serious issues in the future.

To troubleshoot the error:

1. Press the soft key next to “Help With This Error” for help with the active error.

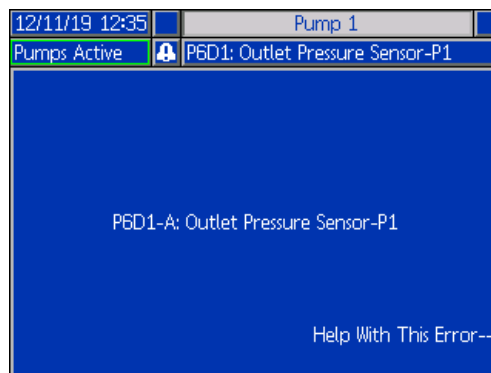

2. The QR Code screen will be displayed. Scan the QR code with your smart phone to be sent directly to online troubleshooting for the active error code.



NOTE: For causes and solutions for each error code, refer to the **Error Codes** table on page 56. You can also call Graco Technical Assistance or navigate to: <http://help.graco.com/en/e-flo-systems/e-flo-iq-system.html>.

Error Codes

Error	Location	Type	Error Name	Error Description	Cause	Solution
A1__	AMZ	Alarm	Low Current H_Z_	Heater current is below the minimum allowed value	Fault heater element	Check heater resistance and resistance to ground. Replace faulty heater.
A2__	AMZ	Advisory	Low Current H_Z_	Heater current is below the minimum allowed value	Fault heater element	Check heater resistance and resistance to ground. Replace faulty heater.
A3__	AMZ	Alarm	High Current H_Z_	Heater current exceeds maximum allowed value	Heater element is defective	Replace heater element.
					Heater element is shorted	Check wiring to the heater element to ensure no bare wires are touching and that no wires are shorted to ground.
A4J_	Driver	Alarm	High Motor Current P_	Motor current exceeds maximum allowed value	Encoder malfunction	Replace encoders.
					Short circuit of motor wiring	Check wiring to the motor to ensure no bare wires are touching and that no wires are shorted to ground.
					Motor not able to rotate	Check that motor shaft rotates freely.
					Flow rate is too large for the motor to drive the pumps at the operating pressure	Reduce the outlet flow rate.
A4N_	Driver	Alarm	High Motor Current P_	Motor current exceeds maximum allowed value	Encoder malfunction	Replace encoders.
					Short circuit of motor wiring	Check wiring to the motor to ensure no bare wires are touching and that no wires are shorted to ground.
					Motor not able to rotate	Check that motor shaft rotates freely.
					Faulty circuit board	Replace motor control circuit board.
A4__	AMZ	Alarm	High Current H_Z_	Heater current exceeds maximum allowed value	Heater element is defective	Replace heater element.
					Heater element is shorted	Check wiring to the heater element to ensure no bare wires are touching and that no wires are shorted to ground.
A7__	AMZ	Alarm	Unexpected Current H_Z_	Heat current has an unexpected current flow	Unexpected Current flow to the heat element	Fault heater element. Check heater resistance and resistance to ground. Replace heater element.
						Faulty AMZ; replace AMZ.

Error	Location	Type	Error Name	Error Description	Cause	Solution
A8__	AMZ	Alarm	No Current H_Z_	Power is not getting to heating element	Power not getting to heating element	Check fuse on the AMZ that the error element is connected to.
						Check that electrical connector on the heated hose is plugged into the AMZ.
						Check continuity of pins C and D on electrical connector at AMZ end of heated element. See heated element manual for impedance measurements. Replace hose if readings are too high.
CAC_	ADM	Alarm	Communication Error P_	Communication lost between ADM and pump	No 24 VDC power supply to ADM	Reconnect or replace CAN cable connecting driver and ADM. If CAN connection good, check 24V power supply wiring in driver. Make sure AC power to pump is turned off before checking power supply. Yellow LED on driver connector board should be flashing.
					Cross threaded CAN cable	CAN cables carry 24 V DC power and communication between modules. A cross threaded CAN cable connector may cause problems with communication and/or power to modules. Carefully check for cross threaded CAN connections on the ADM and driver. Yellow LED on driver connector board should be flashing.
CBD_	Driver	Alarm	Communication Error P_	Communication lost between pump and ADM	No AC power to driver	Verify pump is turned on by confirming disconnect switch is in the ON position. Yellow LED on driver connector board should be flashing.
					AC disconnect switch broken	Disconnect pump from AC power. Check wiring to switch. If wiring is good, replace the AC disconnect switch.
					Ribbon cable disconnected	Disconnect pump from AC power. Verify that the ribbon cable inside driver casing is connected.
					Faulty driver control board	Replace driver control board.
CBGX	Gateway	Alarm	Fieldbus Reset	The fieldbus has performed a reset	Changing the fieldbus setup properties	No action necessary.
CBT_	AMZ	Alarm	Communication Error H_	Communication lost between AMZ MZLP4 and ADM	No AC power to the AMZ MZLP4	Verify AMZ MZLP4 is turned on by confirming disconnect switch of the heat box is in the ON position.
					AC disconnect switch broken	Disconnect AMZ MZLP4 from AC power. Check wiring to switch. If wiring is good, replace the AC disconnect switch of the heat box.
					Faulty AMZ MZLP4 control board	Replace AMZ MZLP4 control board.

Error	Location	Type	Error Name	Error Description	Cause	Solution
CBV_	AMZ	Alarm	Communication Error H_	Communication lost between AMZ DB and ADM	No AC power to the AMZ DB	Verify AMZ DB is turned on by confirming disconnect switch of the heat box is in the ON position.
					AC disconnect switch broken	Disconnect AMZ DB from AC power. Check wiring to switch. If wiring is good, replace the AC disconnect switch of the heat box.
					Faulty AMZ DB control board	Replace AMZ DB control board.
CCD_	Driver	Alarm	Duplicate Module P_	Multiple pumps using same pump ID	Two or more pumps have the same pump ID	Update the pumps displaying the error to the latest software available on help.graco.com.
CCF_	FCM	Alarm	FCM Comm. Error P_	No communication with the FCM	The FCM lost communication with the pump	Restore communication.
CCG_	Gateway	Alarm	Fieldbus Comm. Error P_	No communication with the fieldbus	The automation gateway lost communication with the automation controller	Restore communication.
CCH_	Gateway	Alarm	Fieldbus Comm. Error H_	No communication with the fieldbus	The automation gateway lost communication with the heat automation controller	Restore communication.
CCN_	Driver	Alarm	Control Board P_	Communication lost between driver hot and cold boards	Software update failure	If software updates to the hot or cold driver boards fail before completion, then they will not be able to communicate. Update software to the latest available on help.graco.com.
					Cold board disconnected from hot board	Disconnect pump from AC power. Verify the cold board is securely fastened on the spacers above the hot board.
					Faulty driver control board	Replace driver control board.
CCT_	AMZ	Alarm	Duplicate Module H_	Multiple AMZ MZLP4s using same module ID	Two or more AMZ MZLP4s have the same module ID	Turn dial on AMZ to a non used module ID.
CCV_	AMZ	Alarm	Duplicate Module H_	Multiple AMZ DBs using same module ID	Two or more AMZ DBs have the same module ID	Turn dial on AMZ to a non used module ID.
DB1_ DB2_	Pump	Alarm or Deviation (user selectable)	Pump Not Primed P_	Pump has not been primed since last empty drum	Replacing an empty drum with a new one	After replacing an empty drum, the pump must be primed before returning to operation (if alarm selected). Go to the pump run screen and push the lower right softkey to bring the priming sequence, then press the upper right softkey. Set the priming time in the setup screens. If deviation selected, prime pump if desired or clear deviation and return to normal pump operation.

Error	Location	Type	Error Name	Error Description	Cause	Solution
DD3_ DD4_	Pump	Alarm or Deviation (user selectable)	Pump Diving P_	Pump diving detected	Flow to pump inlet restricted	Check inlet valve is open or check inlet supply system for clogs.
DKC_	Pump	Alarm	Crossover Error P_	Crossover error in tandem system	Second pump is in error state when crossover takes place	Clear the error on the second pump.
EUD_	Driver	Advisory	Auto Depressurization Occurred	The pump has auto depressurized	The pump was auto depressurized due to the fact that the pump did not move for the auto depressurize timer	Remember to primary/purge system before running production.
EUH_	AMZ	Record Only	Heat Idle Timeout	Automatically turns off heat after the pump has not moved for the designated amount of time	All zones on heat module were successfully turned off	No action necessary.
EAL_	ADM	Record Only	Access Granted - _____	Access to locked screen(s) has been granted	A password has been successfully inserted into the display	No action necessary if desired. Else verify settings are correct.
EAUX	ADM	Advisory	Download to USB In Process	Information is currently being downloaded to USB	Download to USB initiated	No action necessary. Self-clearing.
EAW_	AMZ	Record Only	Heat_ Module Warming Up	All zones on heat module are in warming up state	All zones on heat module were successfully placed into warm up	No action necessary.
EBUX	ADM	Advisory	Download to USB Complete	Download to USB is complete	All requested information has finished downloading to USB	No action necessary. Self-clearing.
EBH_	AMZ	Record Only	Heat_ Module Off	All zones on heat module are turn off	All zones on heat module were successfully turned off	No action necessary.
EC0X	ADM	Record Only	Setup Values Changed	A setting in the setup screen was changed	A setting in the setup screens was changed	No action necessary if changes were desired.
EDF_	AMZ	Record Only	Heat_ Module Placed into Heat Soak	All zones on heat module are in heat soak state	All zones on heat module were successfully placed into heat soak	No action necessary.
EDS_	AMZ	Record Only	Heat_ Module Placed into Setback	All zone on heat module are in setback state	All zones on heat module were successfully placed into setback	No action necessary.

Troubleshooting

Error	Location	Type	Error Name	Error Description	Cause	Solution
EDT_	AMZ	Record Only	Heat_ Module is at desired temperature	All zone on heat module are at desired temperature	All zones on heat module have successfully reached the desired temperature	No action necessary if the desired temperature was reached.
EKA	Pump	Record Only	Automatic Crossover to P_	The system has success crossover to the other the other pump	The alarm in the system requested a crossover to the other pump	No action necessary.
EKM	Pump	Record Only	Manual Crossover to P_	The system has received a crossover request	The system has received a crossover request from the ADM or CGM	No action necessary.
ELOX	ADM	Record Only	Power On	The ADM was powered on	The ADM was powered on	No action necessary.
EMOX	ADM	Record Only	Power Off	The ADM was powered off	The ADM was powered off	No action necessary.
EVUX	ADM	Advisory	USB Disabled	USB downloads/uploads are disabled	USB download/upload was attempted, but USB activity is disabled within the setup screen	Advisory will clear when drive is removed. Enable USB downloads/uploads in setup screen if desired and reinsert USB drive.
F1D_ F2D_	Pump	Alarm or Deviation (user selectable)	Low Flow Rate P_	Measured flow rate less than desired flow rate minus tolerance	Fluid supply too low to achieve desired flow rate	Increase fluid pressure to reach desired rate.
					Clog in fluid supply system	Check hose and other components in fluid supply system for clogs.
					No air pressure to solenoid valves	Turn on air to solenoid valves.
					No material supply	Replace drum and prime pump if desired.
					Incorrect flow tolerance	Enter correct flow tolerance percentage in setup screen.
F3D_ F4D_	Pump	Alarm or Deviation (user selectable)	High Flow Rate P_	Measured flow rate greater than desired flow rate plus tolerance	Incorrect flow tolerance	Enter correct flow tolerance percentage in setup screen.
L1C_	Pump	Alarm	Drum Empty P_	Drum is empty	Drum is empty and needs to be replaced	Replace drum and prime pump if desired.
					Drum level sensor is disconnected	Verify level sensor is connected. Replace sensor if connection is good.
L2C_	Pump	Deviation	Drum Empty P_	Drum level is low	Fluid level in drum is low. Consider replacing soon	Clear deviation and return to normal pump operation.
					Drum level sensor is disconnected	Verify level sensor is connected. Replace sensor if connection is good.

Error	Location	Type	Error Name	Error Description	Cause	Solution
MMUX	ADM	Advisory	USB Log 90% Full	One or more USB log is 90% full.	Data in the jobs or events log has not been downloaded recently and logs are nearly full	Download the data or disable USB errors.
MAD_	Pump	Advisory	Maint. Due Pump P_	Maintenance due for pump	The number of pump cycles since last reset has exceeded the maintenance limit set	Perform desired maintenance and reset the pump cycles in the setup screen.
MBD_	Pump	Advisory	Maint. Due Driver P_	Maintenance due for driver	The number of driver cycles since last reset has exceeded the maintenance limit set	Perform desired maintenance and reset the driver cycles in the setup screen.
MLC_	Pump	Advisory	Rebuild Platen Seals P_	Maintenance due for platen seals	The number of replaced drums since last cycles reset has exceeded the maintenance limit set	Rebuild the platen seals if desired and reset the platen cycles in the setup screen.
MLD_	Pump	Advisory	Maint. Due Platen Valve P_	Maintenance due for platen valve	The number of platen valve cycles since last reset has exceeded the maintenance limit set	Perform desired maintenance and reset the platen valve cycles in the setup screen.
MED_	Pump	Advisory	Maint. Due Dispense Valve P_	Maintenance due for dispense valve	The number of dispense valve cycles since last reset has exceeded the maintenance limit set	Perform desired maintenance and reset the dispense valve cycles in the setup screen.
MG2_	Pump	Advisory	Low Filter Pressure P_	Low filter pressure drop detected	The filter has an opening in it	Replace the fluid filter.
MG3_	Pump	Advisory	High Filter Pressure P_	High filter pressure drop detected	There is a clog in the manifold	Clean out the manifold to reduce the pressure.
P1C_ P2C_	Pump	Alarm or Deviation (user selectable)	Low Pressure P_	Measured outlet pressure less than desired outlet pressure minus tolerance	Incorrect pressure tolerance	Enter correct pressure tolerance percentage in setup screen.
					Failed pressure transducer	Check transducer, replace if failed.
					No or insufficient material flow	Increase material flow.
					Restrictor not closed enough	Slowly close restrictor to build pressure.

Error	Location	Type	Error Name	Error Description	Cause	Solution
P4C_ P3C_	Pump	Alarm or Deviation (user selectable)	High Pressure P_	Measured outlet pressure greater than desired outlet pressure plus tolerance	Incorrect pressure tolerance	Enter correct pressure tolerance percentage in setup screen.
					Failed pressure transducer	Check transducer, replace if failed.
					Clog in fluid supply system	Check hose and other components in fluid supply system for clogs.
P6D_	Pump	Deviation	Outlet Pressure Sensor P_	Outlet pressure transducer not connected	The outlet pressure transducer is not connected or faulty	Verify outlet pressure transducer is installed and/or connected correctly. Replace if necessary.
P6V_	Pump	Alarm	Valve Pressure Sensor P_	Valve pressure transducer not connected.	The valve pressure transducer is not connected to the driver or faulty	Verify valve pressure transducer is installed and/or connected properly. Replace if necessary.
P6X_	Pump	Alarm	Valve Pressure Sensor	Valve pressure transducer not connected.	The valve pressure transducer is not connected to the fluid cube or faulty	Verify valve pressure transducer is installed and/or connected properly. Replace if necessary.
TA_	AMZ	Alarm	Heat Zone Offline Z_H_	The heat zone is offline	The AMZ lost communication with the other Tandem AMZ	Restore communication.
T1_	AMZ	Alarm	Low Temperature H_Z_	Temperature of the zone is below the setpoint	Zone has reached setpoint but dropped below setpoint and can not recover	Check resistance of heater rods. Refer to manual for resistance.
						Adjust the temp offset errors in the Heat Setup screen.
T2J_	Driver	Deviation	Motor Temperatures Sensor P_	Motor temperature thermistor disconnected	The motor temperature thermistor is not connected or faulty	Verify motor temperature thermistor is installed and/or connected correctly. Replace if necessary.
T2_	AMZ	Advisory	Low Temperature H_Z_	Temperature of the zone is below the setpoint	Zone has reached setpoint but dropped below setpoint and can not recover	Check resistance of heater rods. Refer to manual for resistance.
						Adjust the temp offset errors in the Heat Setup screen.
T3J_	Driver	Deviation	Temperature Cutback P_	Current supplied to motor is being reduced in order to lower driver temperature	The control board temperature inside the driver is too high	Ensure ambient temperature is below 120F (48C). Ensure the enclosure fans are working properly.
					Enclosure fan not operating	Verify fan in electrical enclosure is spinning. If it is not, disconnect pump from AC power and check fan wiring or replace fan.

Error	Location	Type	Error Name	Error Description	Cause	Solution
T3__	AMZ	Advisory	High Temperature H_Z_	The zone temperature has exceeded the setpoint	Element continues to raise above the setpoint	Defective RTD. Replace.
					RTD not in correct location on element	See manual to find correct location of RTD on element.
					Temperature reading has risen too high.	Adjust the temp offset errors in the Heat Setup screen.
T4J_	Driver	Alarm	High Controls Temperature P_	Temperature of the control board is too hot	The control board temperature inside the driver is too high	Ensure ambient temperature is below 120F (48C).
					Enclosure fan not operating	Verify fan in electrical enclosure is spinning. If it is not, disconnect pump from AC power and check fan wiring or replace fan.
T4M_	Driver	Alarm	High Motor Temperature P_	Temperature of the motor is too hot	The motor temperature inside the driver is too high	Ensure ambient temperature is below 120F (48C).
					Enclosure fan not operating	Verify fan in electrical enclosure is spinning. If it is not, disconnect pump from AC power and check fan wiring or replace fan.
T4__	AMZ	Alarm	High Temperature H_Z_	The zone temperature has exceeded the setpoint	Element continues to raise above the setpoint	Defective RTD. Replace.
					RTD not in correct location on element	See manual to find correct location of RTD on element.
T6__	AMZ	Alarm	Sensor Error H_Z_	The zone has no reading from RTD	No reading from the RTD of the heat zone	Check the wired connections to make sure that RTD is wired correctly.
						Defective RTD. Replace.
T8__	AMZ	Alarm	No Temperature Rise H_Z_	The zone temperature does not changed	The zone temperature does not changed	Check fuse on the AMZ that the error element is connected to.
						Check that electrical connector on the heated hose is plugged into the AMZ.
						Defective heater rods in element. Replace.
V1M_	Driver	Alarm	Low Voltage P_	Supplied bus voltage is below minimum acceptable limit	Transformer faulty	Check output voltage of transformer to verify it is within acceptable input limits.
					Incorrect line voltage	Check line voltage to verify it is as expected (230V, 380V, etc.).
V2H_	AMZ	Deviation	Low Voltage H_	The incoming power is below minimum acceptable limit	Incoming line to line voltage has dropped below 175V	Verify incoming power is correct gauge for current draw and verify incoming power lines are securely attached to disconnect.
V4M_	Driver	Alarm	High Voltage P_	Supplied bus voltage is above maximum acceptable limit	Transformer faulty	Check output voltage of transformer to verify it is within acceptable input limits.
					Incorrect line voltage	Check line voltage to verify it is as expected (230V, 380V, etc.).

Error	Location	Type	Error Name	Error Description	Cause	Solution
V4H_	AMZ	Alarm	High Voltage H_	The incoming power is above minimum acceptable limit	Incoming line to line voltage has increased above 265V	For 3 phase with neutral have qualified electrician verify neutral wire.
V6H_	AMZ	Alarm	Wiring Error H_	The wiring is invalidated from what the AMZ is expecting	Wrong wiring of the power source to the AMZ	Verify incoming power is wired to the disconnect correctly per the manual.
WBD_	Driver	Alarm	Encoder Hardware P_	Encoder or hall sensor disconnected or failed to commutate motor	Encoder disconnected or faulty	Disconnect pump from AC power. Verify encoder cable is properly connected. If so, replace encoder.
WMC_	Driver	Alarm	Control Board P_	Control board reset due to an exception in software	Invalid software state	Cycle the power to the pump to reset the driver software.
					Software bug	Update software to the latest available on help.graco.com.
WMH_	Driver	Alarm	Control Board Off P_	The power to the control board has been turned off	Disconnected switches	Turn on the disconnected switches.
WMG0	Gateway	Alarm	Gateway Error Detected	Gateway error detected; includes any error not covered by a more specific error	---	---
WMN_	Driver	Alarm	Software Mismatch P_	Software mismatch detected in the motor control board	Hot board and cold board have different software versions	Update the driver control board software to the latest available on help.graco.com.
WNG0	Gateway	Alarm	Gateway Map Error	Missing or invalid gateway map	Missing or invalid gateway map	Install map in gateway.
WSC_	Driver	Deviation	Encoder Calibration P_	Encoder calibration information not found	Encoder not calibrated before or calibration information deleted	Perform encoder calibration through the setup screens of the ADM.
WSU0	ADM	Alarm	USB Configuration Error	USB configuration file not detected	USB configuration file not loaded or was deleted	Update software to the latest available on help.graco.com.
WSN_	Driver	Alarm	Invalidated Styled	Style flow rate setpoint was invalidated when trying to run	The style flow rate setpoint was zero	Place a desired flow rate in the style definitions page.

USB Data

Download Procedure

NOTE: If log files are not correctly saving to the USB flash drive (for example, missing or empty log files), save the desired data off of the USB flash drive and reformat it before repeating the download procedure.

NOTE: System configuration setting files and custom language files can be modified if the files are in the UPLOAD folder of the USB flash drive. See **System Configuration Settings**, page 66, **Custom Language File**, page 66, and **Upload Procedure** on page 67.

1. Insert the USB flash drive into the USB port.
2. The Menu Bar and USB indicator lights indicate that the USB is downloading files. Wait for USB activity to complete.
3. Remove the USB flash drive from the USB port.
4. Re-insert the USB flash drive into the USB port of computer.
5. The USB flash drive window automatically opens. If it does not, open the USB flash drive from within Windows[®] Explorer.
6. Open the GRACO folder.
7. Open the system folder. If downloading data from more than one system, there will be more than one folder. Each folder is labeled with the corresponding serial number of the ADM
NOTE: The serial number is on back of the ADM.
8. Open the DOWNLOAD folder.
9. Open the DATAxxxx folder.
10. Open the DATAxxxx folder labeled with the highest number. The highest number indicates the most recent data download.
11. Open the log file. Log files open in Microsoft[®] Excel by default as long as the program is installed. However, they can also be opened in any text editor or Microsoft[®] Word.

NOTE: All USB logs are saved in Unicode (UFT-16) format. If opening the log file in Microsoft Word, select Unicode encoding.

USB Logs

NOTE: The ADM can read/write to FAT (File Allocation Table) storage devices. NTFS, used by 32 GB or greater storage devices, is not supported.

During operation, the ADM stores system and performance related information to memory in the form of log files. The ADM maintains six log files:

- Event Log
- Pump X Log
- Cycles Log

Follow the **Download Procedure**, page 65, to retrieve log files.

Each time a USB flash drive is inserted into the ADM USB port, a new folder named DATAxxxx is created. The number at the end of the folder name increases each time a USB flash drive is inserted and data is downloaded or uploaded.

Event Log

The event log file name is 1-EVENT.CSV and is stored in the DATAxxxx folder.

The event log maintains a record of the last 1,000 events and errors. Each event record contains:

- Date of event code
- Time of event code
- Event code
- Event Type
- Event Description

Event codes include both error codes (alarms, deviations, and advisories) and record only events.

Job Log

The job log file name is 9-JOB.SCV and is stored in the DATAxxx folder. There will be a new entry in the job log when the E-Flo iQ receives a “Dispense Complete” signal or when the Style Enabled goes high to low.

The job log maintains a record of the last 1,000 jobs that were performed. Each job log record contains:

- Date of job
- Time of job
- Pump ID
- Style number
- Actual amount (cc)
- Pump (Pressure)
- Valve (Pressure)

Automation Log

The automation log file name is 10-AUTOM.csv and is stored in the DATAxxx folder.

The automation log records the change in status of the job cycle along with the input signals status. The parameters recorded in this log are listed below:

- Date of job
- Time of job
- Pump ID
- Style number
- System time (ms)
- Style Enabled
- Go signal status
- Dispense complete signal status
- Dispense valve signal
- Pre-charge or de-charge active

NOTE: The automation log will only be recorded when there is a change in these parameters or in the automation status bits that are used by Graco to further diagnose the status of the system.

System Configuration Settings

The system configuration settings file name is SETTINGS.TXT and is stored in the DOWNLOAD folder.

A system configuration settings file automatically downloads each time a USB flash drive is inserted into the ADM. Use this file to back up system settings for future recovery or to easily replicate settings across multiple systems. Refer to the **Upload Procedure** on page 67 for instructions on how to use this file.

Custom Language File

The custom language file name is DISPTXT.TXT and is stored in the DOWNLOAD folder.

A custom language file automatically downloads each time a USB flash drive is inserted into the ADM. If desired, use this file to create a user-defined set of custom language strings to be displayed within the ADM.

The system is able to display the following Unicode characters. For characters outside of this set, the system will display the Unicode replacement character, which appears as a white question mark inside of a black diamond.

- U+0020 - U+007E (Basic Latin)
- U+00A1 - U+00FF (Latin-1 Supplement)
- U+0100 - U+017F (Latin Extended-A)
- U+0386 - U+03CE (Greek)
- U+0400 - U+045F (Cyrillic)

Create Custom Language Strings

The custom language file is a tab-delimited text file that contains two columns. The first column consists of a list of strings in the language selected at the time of download. The second column can be used to enter the custom language strings. If a custom language was previously installed, this column contains the custom strings. Otherwise the second column is blank.

Modify the second column of the custom language file as needed and then follow the **Upload Procedure** on this page to install the file.

The format of the custom language file is critical. The following rules must be followed for the installation process to succeed.

- Define a custom string for each row in the second column.
NOTE: If the custom language file is used, you must define a custom string for each entry in the DISPTXT.TXT file. Blank second-column fields will be displayed blank on the ADM.
- The file name must be DISPTXT.TXT.
- The file format must be a tab-delimited text file using Unicode (UTF-16) character representation.
- The file must contain only two columns, with columns separated by a single tab character.
- Do not add or remove rows to the file.
- Do not change the order of the rows.

Upload Procedure

Use this procedure to install a system configuration file and/or a custom language file.

1. If necessary, follow the **Download Procedure** on page **65** to automatically generate the proper folder structure on the USB flash drive.
2. Insert a USB flash drive into the USB port of computer.
3. The USB flash drive window automatically opens. If it does not, open the USB flash drive from within Windows Explorer.
4. Open the GRACO folder.
5. Open the system folder. If working with more than one system, there will be more than one folder within the GRACO folder. Each folder is labeled with the corresponding serial number of the ADM (the serial number is on the back of the module).
6. If installing the system configuration settings file, place the SETTINGS.TXT file into the UPLOAD folder.
7. If installing the custom language file, place the DISPTXT.TXT file into the UPLOAD folder.
8. Remove the USB flash drive from the computer.
9. Install the USB flash drive into the ADM USB port.
10. The Menu Bar and USB indicator lights indicate that the USB is downloading files. Wait for USB activity to complete.
11. Remove the USB flash drive from the USB port.

NOTE: If the custom language file was installed, you can select the new language from the Language drop-down menu in **Advanced Setup Screen 1** on page **32**.

Integration

Discrete Inputs/Outputs

NOTE: Connecting the ground on Connector 4, pin 3 is required for the electric driver (AB) to receive valid signals.

NOTE: See **Connector Identification** on page 69.

Connector	Pin Use	Pin (Wire Color)	Graco Input / Output	Description
1	Graco	-	Communications and 24 VDC Power	GCA CAN port. Connection to ADM, CGM, or another MCM
2	Graco	-	Communications and 24 VDC Power	GCA2 CAN port. Connection to ADM, CGM, or another MCMC
3	Graco	1 (brown)	24 VDC Digital Output <ul style="list-style-type: none"> • 24V is ON • 0V is OFF 	24V power for Level sensor(s)
	Graco	2 (white)	24 VDC Digital Input <ul style="list-style-type: none"> • > 4V is ON • < 1 V is OFF 	Empty Level Sensor Input: When the sensor detects an empty drum, the input pin will be OFF.
	Graco	3 (blue)	Ground / Return	Ground / Return
	Graco	4 (black)	24 VDC Digital Output <ul style="list-style-type: none"> • 24V is ON • 0V is OFF 	Platen Valve: When the digital output is ON, the platen valve is opened. Else when the digital output is OFF, the platen valve is closed.
	Graco	5 (gray)	24 VDC Digital Input <ul style="list-style-type: none"> • > 4V is ON • < 1 V is OFF 	Low Level Sensor Input: When the sensor detects a low drum, the input pin will be OFF.
4	Customer	1 (white)	24 VDC Digital Input <ul style="list-style-type: none"> • > 4V is ON • < 1 V is OFF 	Dispense Complete: When the digital input is ON, a job is recorded in the job log. This is a strobed input, and will be brought low. When the digital input is OFF, a job log will not be recorded.
	Customer	2 (brown)	24 VDC Digital Input <ul style="list-style-type: none"> • > 4V is ON • < 1 V is OFF 	Style Enable: When the digital input is ON, the pump will start a job and begin pre-charge if active. When the digital input is OFF, the pump will not be running a job.
	Graco/ Customer	3 (green)	Ground / Return	Ground / Return
	NA	4 (yellow)	+5 VDC Supply	Power (can be used to as logic voltage for digital inputs via relay)
	Customer	5 (gray)	24 VDC Digital Input <ul style="list-style-type: none"> • > 4V is ON • < 1 V is OFF 	System Enable/Remote Start Request: While system in not active (amber LED), when the digital input is strobed, the system will become active.
	Customer	6 (pink)	24 VDC Digital Input <ul style="list-style-type: none"> • > 4V is ON • < 1 V is OFF 	Go Signal: When the digital input is ON, the pump will dispense material. When the digital input is OFF, the pump will not dispense material.
	Graco	7 (blue)	24 VDC Digital Output <ul style="list-style-type: none"> • 24V is ON • 0V is OFF 	Dispense Valve: When the digital output is ON, the dispense valve is opened. When the digital output is OFF, the dispense valve is closed.
	Customer	8 (red)	24 VDC Digital Output <ul style="list-style-type: none"> • 24V is ON • 0V is OFF 	System Ready to Dispense: When the digital output is ON, the pump is ready to dispense. When the digital output is OFF, the pump is not ready to dispense. The pump is able to dispense when not ready, but it is not advised. Below are cases that the digital output pin maybe off: <ul style="list-style-type: none"> • Pump is in an error state • Pump is pre-charging • Pump is dispensing • Pump is changing over • Pump is inactive • Pump heat is not up to temperature or has an error
5	Graco	-	Analog Differential Input	Outlet Pressure Transducer Port (Required)
6	Graco	-	Analog Differential Input	Valve Pressure Transducer Port (Required)

Connector Identification

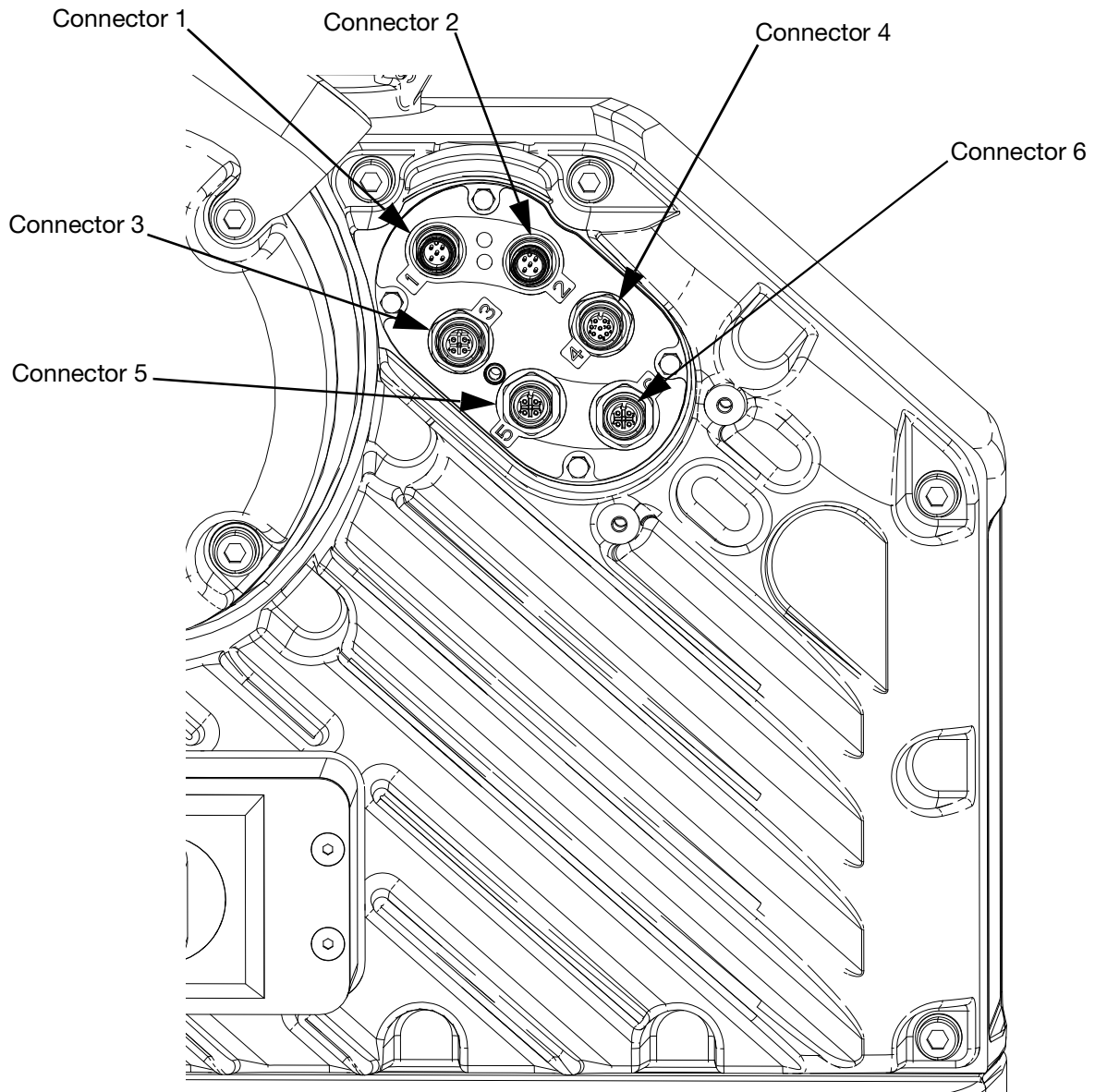

FIG. 9: Electric Driver Connections

Refer to the E-Flo iQ Supply System Installation-Parts Manual for additional information about Electric Driver Connections. See **Related Manuals** on page 3.

Job Cycle Timing Diagram

Timing recommendations:

- Use discrete signals when possible, especially for the Go signal. Use optional I/O Cable 128441 for discrete signals.
- Use a 50 ms delay between bits.

Automation Control Ready in the following diagram represents:

- Pump is active
- No active alarms
- ADM is in Remote mode

Job Cycle Timing Diagram

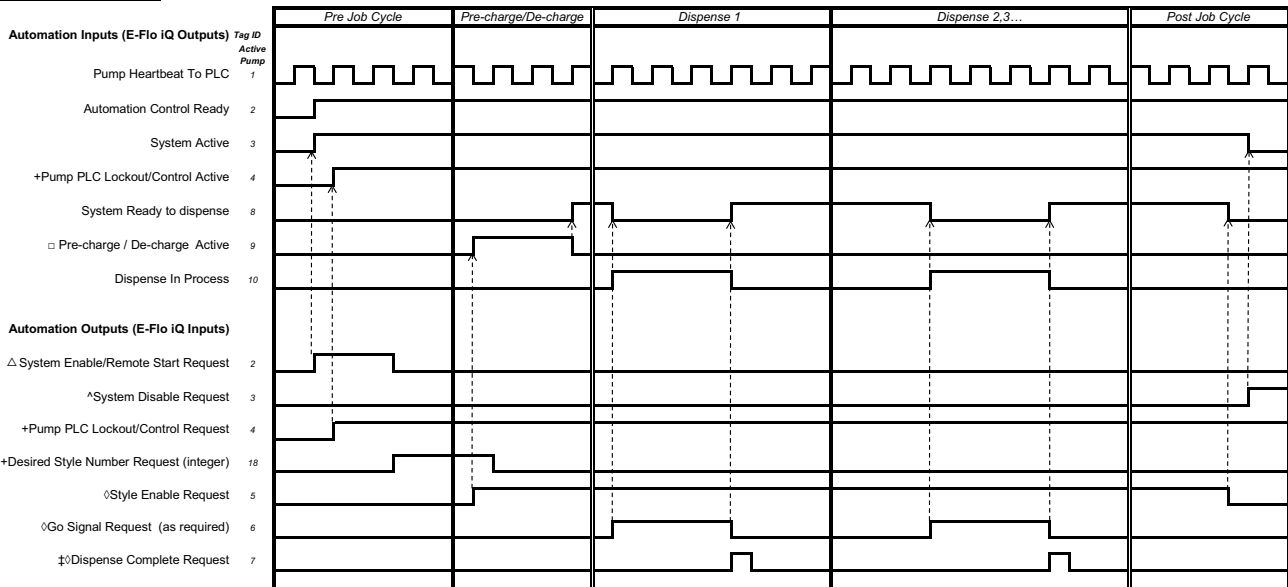

- Notes:**
- * A job cycle can only be completed on the active pump
 - △ Can be enabled at the same time.
 - + Can only be used through the fieldbus; and must be used to operate the system. Styles 17-99 can only be operated through the fieldbus.
 - Pre-charge will only be active when there is a set-point stored in the display or passed over the CGM.
 - ◇ The signal source can be either discrete or fieldbus. Go to "Style Definitions", then navigate to "Style Integration Setup" screen define the source. However, it is highly recommended to use the discrete signal for proper timing.
 - ‡ The dispense complete is optional. This bit summates the volume dispensed any time it is triggered. Dropping the style strobe will also summate the volume dispensed.
 - ^ Disabling the pumps(s) is optional. Does not diable heat.

CGM I/O Sequence		
Function	Sequence	Description
Pre-Job Cycle	1	Check that Heartbeat is toggling ON and OFF at 1Hz.
	2	Check that System Active bit is ON.
		If System Active bit is OFF, Turn ON System Enable bit.
	3	Check that Automation Control Ready bit is ON. Note: Active only when there are no active alarms, the system is enabled and the system is in REMOTE mode.
If Automation Control Ready bit is ON, Turn ON PLC Lockout bit.		
4	Check that PLC Lockout bit is ON.	
	If PLC Lockout/Control bit is ON, Enter desired Style Number (16bit integer).	

Pre-Charge	5	Turn ON Style Enable bit.
	6	Wait for pre-charge/de-charge active bit. This becomes active right after style enable if there is a pre-charge value. (Optional)
	7	Check (wait) that System Ready bit is ON. Note: This is low while system is pre-charging or dispensing.
Dispense 1		If System Ready bit is ON, Turn ON Go Signal bit. Transition from Pre-charge.
	8	Turn OFF Go Signal bit.
	9	Turn ON Dispense Complete bit. (Optional to sum volume of Dispense 1 individually.)
	10	Turn OFF Dispense Complete bit. (Optional to sum volume of Dispense 1 individually.)
Dispense 2	11	Turn ON Go Signal bit.
	12	Turn OFF Go Signal bit.
	13	Turn ON Dispense Complete bit.
	14	Turn OFF Dispense Complete bit.
Post Job Cycle	15	Turn OFF Style Enable bit.
Remotely turn off system (optional)	16	Turn ON System Disable request.

Discrete Timing Diagram

Discrete Timing Diagram

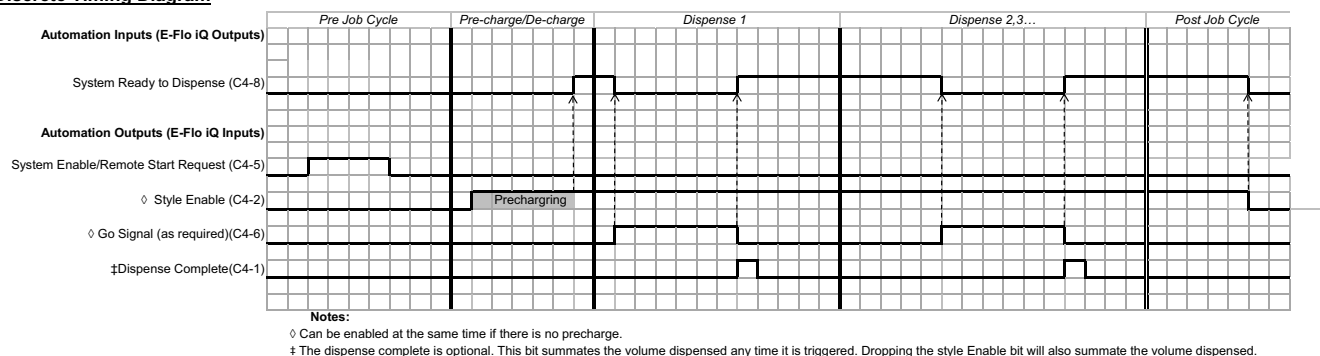

Discrete I/O Sequence		
Function	Sequence	Description
Pre-Job Cycle	1	Select desired style from ADM
	2	Turn ON System Enable Pin (C4-5).
Pre-Charge	3	Turn ON Style Enable Pin (C4-2).
	4	Check that Ready to Dispense pin (C4-8) is ON. Note: This is low while system is pre-charging or dispensing.
Dispense 1	5	If Ready to Dispense is ON, Turn ON Go signal (C4-6).
	6	Turn OFF Go Signal (C4-6).
	7	Turn ON Dispense Complete (C4-1) (Optional to sum volume of Dispense 1 individually).
	8	Turn OFF Dispense Complete (C4-1) (Optional to sum volume of Dispense 1 individually).
Dispense 2	10	Turn ON Go Signal (C4-6).
	11	Turn OFF Go Signal (C4-6).
	12	Turn ON Dispense Complete (C4-1).
	13	Turn OFF Dispense Complete (C4-1).
Post Job Cycle	14	Turn OFF Style Enable Pin (C4-2).

Communications Gateway Module (CGM)

Overview

The Communications Gateway Module (CGM) provides a control link between the E-Flo iQ system and a selected fieldbus. This provides the means for report monitoring and control by external automation systems.

NOTE: The following system network configuration files are available at help.graco.com.

- EDS file: DeviceNet or EtherNet/IP fieldbus networks
- GSD file: PROFIBUS fieldbus networks
- GSDML: PROFINET fieldbus networks

NOTE: See the Supply System Communications Gateway Module Installation Kit manual for CGM installation. See **Related Manuals** on page 3.

E-Flo iQ and PLC Connection Setup

Verify that the PLC parameters are set up correctly, see the Gateway Map table.

NOTE: If the PLC connection parameters are not setup correctly, the connection between the E-Flo iQ and PLC will not be made.

E-Flo iQ Ambient Map	
Gateway Map Token: 18E218	
Map Name on ADM: E-Flo iQ Adv	
Comm. Format	Data-SINT
Input Assembly Instance:	100
Input Instance Size:	70
Output Assembly Instance:	150
Output Instance Size:	24

E-Flo iQ Heated Map	
Gateway Map Token: 18E224	
Map Name on ADM: E-Flo iQ Adv Heat	
Comm. Format	Data-SINT
Input Assembly Instance:	100
Input Instance Size:	94
Output Assembly Instance:	150
Output Instance Size:	40

Available Internal Data

Unless stated otherwise, bytes are stored in each instance in little endian order (byte order within instance: most significant to least significant).

NOTE: Automation Outputs can be monitored by the corresponding Automation Inputs to verify that the E-Flo iQ received the data.

See the **Automation Outputs** on page 73 and the **Automation Inputs** on page 79.

Automation Inputs

NOTE: Print the following tables in color.

Color Coded Key
Active Pump
Inactive Pump
Heat 1 for Pump 1
Heat 2 for Pump 2

A Used for ambient map 18E218.

H Additional to ambient map for heated map 18E224.

E-Flo iQ Maps 18E218 and 18E224							
Automation INPUTS (signal from E-Flo iQ to PLC)							
Instance ID	Description	Data Type	Min Value	Max Value	Bit	Byte	Heat
1	Pump Heartbeat To PLC	Boolean	0	1	0	0	A
2	Automation Control Ready	Boolean	0	1	1		A
3	System Active	Boolean	0	1	2		A
4	Pump PLC Lockout/Control Active	Boolean	0	1	3		A
5	No Alarms are Present	Boolean	0	1	4		A
6	No Deviations are Present	Boolean	0	1	5		A
7	No Advisories are Present	Boolean	0	1	6		A
8	System Ready to dispense	Boolean	0	1	7		A
9	Pre-charge / De-charge Active	Boolean	0	1	0		1
10	Dispense In Process	Boolean	0	1	1	A	
11	Drum Is Low	Boolean	0	1	2	A	
12	Drum Is Empty	Boolean	0	1	3	A	
13	Pump Not Primed	Boolean	0	1	4	A	
14	Pump in Job Cycle	Boolean	0	1	5	A	
15	Prime Active	Boolean	0	1	6	A	
16	Valve Depressurization Active	Boolean	0	1	7	A	
17	Platen Depressurization Active	Boolean	0	1	0	2	A
18	Auto Depressurization Active	Boolean	0	1	1		A
19	Auto Depressurization Happened	Boolean	0	1	2		A
20	Pump is trying to move	Boolean	0	1	3		A
21	Pump is actually moving	Boolean	0	1	4		A
22	Dispense Valve Opened	Boolean	0	1	5		A
23	Platen Valve Opened	Boolean	0	1	6		A
24	Tandem Active Pump (Tandem System only) (0 = Pump 1, 1 = Pump 2)	Boolean	0	1	7		A

E-Flo iQ Maps 18E218 and 18E224							
Automation INPUTS (signal from E-Flo iQ to PLC)							
Instance ID	Description	Data Type	Min Value	Max Value	Bit	Byte	Heat
25	E-Flo iQ Mode Active	Boolean	0	1	0	3	A
26	Changeover Occurred during Dispense	Boolean	0	1	1		A
27	Reserved Bit 1	Boolean	-	-	2		A
28	Reserved Bit 2	Boolean	-	-	3		A
29	Reserved Bit 3	Boolean	-	-	4		A
30	Reserved Bit 4	Boolean	-	-	5		A
31	Reserved Bit 5	Boolean	-	-	6		A
32	Reserved Bit 6	Boolean	-	-	7	A	
33	Actual Pump Flowrate (xxxx cc/min)	uint16	0	6000	0-14	4-5	A
34	Outlet Pressure (xxx.x bar)	uint16	0	413.6	0-14	6-7	A
35	Valve Pressure (xxx.x bar)	uint16	0	413.6	0-14	8-9	A
36	Active Style Loaded (xx)	uint16	0	16-99	0-14	10-11	A
37	Active Style Precharge (xxx.x bar)	uint16	0	413.6	0-14	12-13	A
38	Active Style Flowrate (xxxx cc/min)	uint16	0	6000	0-14	14-15	A
39	Reserved Word 1	uint16	-	-	0-14	16-17	A
40	Actual Amount Dispensed (xxx.xx cc)	uint32	0	21,474,836.00	0-30	18-21	A
41	Reserved Word 2	uint32	-	-	0-30	22-25	A
42	Actual Style Fieldbus Pre-charge Request (xxx.x bars)	uint16	0	413.6	0-14	26-27	A
43	Actual Style Fieldbus Flowrate Request (xxxx cc/min)	uint16	0	6000	0-14	28-29	A
44	Reserved Word 3	uint16	-	-	0-14	30-31	A
45	Pump Position (x.xxxx inches)	uint16	0.0000	4.0000	0-14	32-33	A
46	Actual Style Valve On Delay (xxxx ms)	uint16	0	5000	0-14	34-35	A
47	Actual Style Valve Off Delay (xxxx ms)	uint16	0	5000	0-14	36-37	A
48	Actual Style Motor On Delay (xxxx ms)	uint16	0	5000	0-14	38-39	A
49	Actual Style Motor Off Delay (xxxx ms)	uint16	0	5000	0-14	40-41	A
50	Actual Fieldbus Valve On Delay (xxxx ms)	uint16	0	5000	0-14	42-43	A
51	Actual Fieldbus Valve Off Delay (xxxx ms)	uint16	0	5000	0-14	44-45	A
52	Actual Fieldbus Motor On Delay (xxxx ms)	uint16	0	5000	0-14	46-47	A
53	Actual Fieldbus Motor Off Delay (xxxx ms)	uint16	0	5000	0-14	48-49	A
54	Pump Data Exchange Element Feedback	uint16	0	32767	0-14	50-51	A
55	Pump Data Exchange Element Value Feedback	uint32	See pump data exchange for min and max values		0-30	52-55	A

E-Flo iQ Maps 18E218 and 18E224							
Automation INPUTS (signal from E-Flo iQ to PLC)							
Instance ID	Description	Data Type	Min Value	Max Value	Bit	Byte	Heat
56	Pump Heartbeat To PLC	Boolean	0	1	0	56	A
57	Automation Control Ready	Boolean	0	1	1		A
58	System Active	Boolean	0	1	2		A
59	Pump PLC Lockout/Control Active	Boolean	0	1	3		A
60	No Alarms are Present	Boolean	0	1	4		A
61	No Deviations are Present	Boolean	0	1	5		A
62	No Advisories are Present	Boolean	0	1	6		A
63	System Ready to dispense	Boolean	0	1	7		A
64	Pre-charge / De-charge Active	Boolean	0	1	0	57	A
65	Dispense In Process	Boolean	0	1	1		A
66	Drum Is Low	Boolean	0	1	2		A
67	Drum Is Empty	Boolean	0	1	3		A
68	Pump Not Primed	Boolean	0	1	4		A
69	Pump in Job Cycle	Boolean	0	1	5		A
70	Prime Active	Boolean	0	1	6		A
71	Valve Depressurization Active	Boolean	0	1	7		A
72	Platen Depressurization Active	Boolean	0	1	0	58	A
73	Auto Depressurization Active	Boolean	0	1	1		A
74	Auto Depressurization Happened	Boolean	0	1	2		A
75	Pump is trying to move	Boolean	0	1	3		A
76	Pump is actually moving	Boolean	0	1	4		A
77	Dispense Valve Opened	Boolean	0	1	5		A
78	Platen Valve Opened	Boolean	0	1	6		A
79	Tandem Active Pump (Tandem System only) (0 = Pump 1, 1 = Pump 2)	Boolean	0	1	7		A
80	E-Flo iQ Mode Active	Boolean	0	1	0	59	A
81	Changeover Occurred during Dispense	Boolean	0	1	1		A
82	Reserved Bit 1	Boolean	-	-	2		A
83	Reserved Bit 2	Boolean	-	-	3		A
84	Reserved Bit 3	Boolean	-	-	4		A
85	Reserved Bit 4	Boolean	-	-	5		A
86	Reserved Bit 5	Boolean	-	-	6		A
87	Reserved Bit 6	Boolean	-	-	7		A
88	Actual Pump Flowrate (xxxx cc/min)	uint16	0	6000	0-14	60-61	A
89	Outlet Pressure (xxx.x bar)	uint16	0	413.6	0-14	62-63	A
90	Pump Data Exchange Element Feedback	uint16	0	32767	0-14	64-65	A

E-Flo iQ Maps 18E218 and 18E224							
Automation INPUTS (signal from E-Flo iQ to PLC)							
Instance ID	Description	Data Type	Min Value	Max Value	Bit	Byte	Heat
91	Pump Data Exchange Element Value Feedback	uint32	See pump data exchange for min and max values		0-30	66-69	A
Transition To Heated Map 18E224							
92	Heat Heartbeat To PLC	Boolean	0	1	0	70	H
93	System Heat Enabled	Boolean	0	1	1		H
94	Heat PLC Lockout/Control Active	Boolean	0	1	2		H
95	Heat is On	Boolean	0	1	3		H
96	Heat is Warming Up	Boolean	0	1	4		H
97	Heat is At Temperature	Boolean	0	1	5		H
98	Heat is in Temperature Soak Mode	Boolean	0	1	6		H
99	Heat is in Setback Mode	Boolean	0	1	7		H
100	Heat is Off	Boolean	0	1	0	71	H
101	No Heat Module Alarms are Present	Boolean	0	1	1		H
102	No Heat Module Deviations are Present	Boolean	0	1	2		H
103	No Heat Module Advisories are Present	Boolean	0	1	3		H
104	No Heat Zone(s) Alarms are Present	Boolean	0	1	4		H
105	No Heat Zone(s) Deviations are Present	Boolean	0	1	5		H
106	No Heat Zone(s) Advisories are Present	Boolean	0	1	6		H
107	Heat Idle Timeout Happened	Boolean	0	1	7		H
108	Reserved Bit 1	Boolean	-	-	0	72	H
109	Reserved Bit 2	Boolean	-	-	1		H
110	Reserved Bit 3	Boolean	-	-	2		H
111	Reserved Bit 4	Boolean	-	-	3		H
112	Reserved Bit 5	Boolean	-	-	4		H
113	Reserved Bit 6	Boolean	-	-	5		H
114	Reserved Bit 7	Boolean	-	-	6		H
115	Reserved Bit 8	Boolean	-	-	7		H
116	Reserved Bit 9	Boolean	-	-	0	73	H
117	Reserved Bit 10	Boolean	-	-	1		H
118	Reserved Bit 11	Boolean	-	-	2		H
119	Reserved Bit 12	Boolean	-	-	3		H
120	Reserved Bit 13	Boolean	-	-	4		H
121	Reserved Bit 14	Boolean	-	-	5		H
122	Reserved Bit 15	Boolean	-	-	6		H
123	Reserved Bit 16	Boolean	-	-	7		H
124	Module Heat Soak Time Remaining (xx seconds)	uint16	0	7200	0-14	74-75	H

E-Flo iQ Maps 18E218 and 18E224							
Automation INPUTS (signal from E-Flo iQ to PLC)							
Instance ID	Description	Data Type	Min Value	Max Value	Bit	Byte	Heat
125	Heat Data Exchange Element Feedback	uint16	0	32767	0-14	76-77	H
126	Heat Data Exchange Element Value Feedback	uint32	See heat data exchange for min and max values		0-30	78-81	H
127	Heat Heartbeat To PLC	Boolean	0	1	0	82	H
128	System Heat Enabled	Boolean	0	1	1		H
129	Heat PLC Lockout/Control Active	Boolean	0	1	2		H
130	Heat is On	Boolean	0	1	3		H
131	Heat is Warming Up	Boolean	0	1	4		H
132	Heat is At Temperature	Boolean	0	1	5		H
133	Heat is in Temperature Soak Mode	Boolean	0	1	6		H
134	Heat is in Setback Mode	Boolean	0	1	7		H
135	Heat is Off	Boolean	0	1	0	83	H
136	No Heat Module Alarms are Present	Boolean	0	1	1		H
137	No Heat Module Deviations are Present	Boolean	0	1	2		H
138	No Heat Module Advisories are Present	Boolean	0	1	3		H
139	No Heat Zone(s) Alarms are Present	Boolean	0	1	4		H
140	No Heat Zone(s) Deviations are Present	Boolean	0	1	5		H
141	No Heat Zone(s) Advisories are Present	Boolean	0	1	6		H
142	Heat Idle Timeout Happened	Boolean	0	1	7		H
143	Reserved Bit 1	Boolean	-	-	0	84	H
144	Reserved Bit 2	Boolean	-	-	1		H
145	Reserved Bit 3	Boolean	-	-	2		H
146	Reserved Bit 4	Boolean	-	-	3		H
147	Reserved Bit 5	Boolean	-	-	4		H
148	Reserved Bit 6	Boolean	-	-	5		H
149	Reserved Bit 7	Boolean	-	-	6		H
150	Reserved Bit 8	Boolean	-	-	7		H
151	Reserved Bit 9	Boolean	-	-	0	85	H
152	Reserved Bit 10	Boolean	-	-	1		H
153	Reserved Bit 11	Boolean	-	-	2		H
154	Reserved Bit 12	Boolean	-	-	3		H
155	Reserved Bit 13	Boolean	-	-	4		H
156	Reserved Bit 14	Boolean	-	-	5		H
157	Reserved Bit 15	Boolean	-	-	6		H
158	Reserved Bit 16	Boolean	-	-	7		H
159	Module Heat Soak Time Remaining (xx seconds)	uint16	0	7200	0-14	86-87	H

<i>E-Flo iQ Maps 18E218 and 18E224</i>							
Automation INPUTS (signal from E-Flo iQ to PLC)							
Instance ID	Description	Data Type	Min Value	Max Value	Bit	Byte	Heat
160	Heat Data Exchange Element Feedback	uint16	0	32767	0-14	88-89	H
161	Heat Data Exchange Element Value Feedback	uint32	See heat data exchange for min and max values		0-31	90-93	H

Automation Outputs

NOTE: Print the following tables in color.

Color Coded Key
Active Pump Only
Active (Ram Unit) or Inactive (Tandem Unit) Pump
Heat 1 for Pump 1
Heat 2 for Pump 2

A Used for ambient map 18E218.

H Additional to ambient map for heated map 18E224.

E-Flo iQ Maps 18E218 and 18E224							
Automation OUTPUTS (signal from PLC to E-Flo iQ)							
Instance ID	Description	Data Type	Min Value	Max Value	Bit	Byte	Heat
1	SYS - Data Exchange Element Command	uint16	0	32767	0-14	0-1	A
2	System Enable/Remote Start Request	Boolean	0	1	0	2	A
3	System Disable Request	Boolean	0	1	1		A
4	Pump PLC Lockout/Control Request	Boolean	0	1	2		A
5	Style Enable Request	Boolean	0	1	3		A
6	Go Signal Request (use discrete signal for proper timing!)	Boolean	0	1	4		A
7	Dispense Complete Request	Boolean	0	1	5		A
8	Tandem Crossover Request	Boolean	0	1	6		A
9	Prime Pump Request (Tandem Unit sent to Inactive Pump) (Ram Unit sent to Active Pump)	Boolean	0	1	7		A
10	Valve Depressurization Request	Boolean	0	1	0		3
11	Platen Depressurization Request	Boolean	0	1	1	A	
12	Auto Depressurization Cancel Request	Boolean	0	1	2	A	
13	Acknowledge / Clear Errors Request (both pumps)	Boolean	0	1	3	A	
14	Reserved Bit 1	Boolean	-	-	4	A	
15	Reserved Bit 2	Boolean	-	-	5	A	
16	Reserved Bit 3	Boolean	-	-	6	A	
17	Reserved Bit 4	Boolean	-	-	7	A	
18	Desired Style Number Request	uint16	0	16	0-14	4-5	A
19	Style Fieldbus Pre-charge Target (xxx.x bars)	uint16	0.0	413.6	0-14	6-7	A
20	Style Fieldbus Flow-rate Target (xxxx cc/min)	uint16	0	6000	0-14	8-9	A

E-Flo iQ Maps 18E218 and 18E224							
Automation OUTPUTS (signal from PLC to E-Flo iQ)							
Instance ID	Description	Data Type	Min Value	Max Value	Bit	Byte	Heat
21	Reserved Word 1	uint16	-	-	0-14	10-11	A
22	Prime Pressure Target (xxx.x bar) (Tandem Unit sent to Inactive Pump) (Ram Unit sent to Active Pump)	uint16	0	413.6	0-14	12-13	A
23	Prime Flow Target (xxxx cc/min) (Tandem Unit sent to Inactive Pump) (Ram Unit sent to Active Pump)	uint16	0	6000	0-14	14-15	A
24	Valve On Delay Target (xxxx ms)	uint16	0	5000	0-14	16-17	A
25	Valve Off Delay Target (xxxx ms)	uint16	0	5000	0-14	18-19	A
26	Motor On Delay Target (xxxx ms)	uint16	0	5000	0-14	20-21	A
27	Motor Off Delay Target (xxxx ms)	uint16	0	5000	0-14	22-23	A
Transition To Heated Map 18E224							
28	System Heat Enabled Request	Boolean	0	1	0	24	H
29	System Heat Disable Request	Boolean	0	1	1		H
30	Heat PLC Lockout/Control Request	Boolean	0	1	2		H
31	Heat On Request	Boolean	0	1	3		H
32	Heat Off Request	Boolean	0	1	4		H
33	Heat Setback Request	Boolean	0	1	5		H
34	Acknowledge / Clear Heat Errors Request	Boolean	0	1	6		H
35	Reserved Bit 1	Boolean	-	-	7	25	H
36	Reserved Bit 2	Boolean	-	-	0		H
37	Reserved Bit 3	Boolean	-	-	1		H
38	Reserved Bit 4	Boolean	-	-	2		H
39	Reserved Bit 5	Boolean	-	-	3		H
40	Reserved Bit 6	Boolean	-	-	4		H
41	Reserved Bit 7	Boolean	-	-	5		H
42	Reserved Bit 8	Boolean	-	-	6		H
43	Reserved Bit 9	Boolean	-	-	7		H
44	Heat Data Exchange Element Command	uint16	0	32767	0-14	26-27	H
45	Heat Data Exchange Element Value Command	uint32	See heat data exchange for min and max values		0-30	28-31	H

E-Flo iQ Maps 18E218 and 18E224							
Automation OUTPUTS (signal from PLC to E-Flo iQ)							
Instance ID	Description	Data Type	Min Value	Max Value	Bit	Byte	Heat
46	System Heat Enabled Request	Boolean	0	1	0	32	H
47	System Heat Disable Request	Boolean	0	1	1		H
48	Heat PLC Lockout/Control Request	Boolean	0	1	2		H
49	Heat On Request	Boolean	0	1	3		H
50	Heat Off Request	Boolean	0	1	4		H
51	Heat Setback Request	Boolean	0	1	5		H
52	Acknowledge / Clear Heat Errors Request	Boolean	0	1	6		H
53	Reserved Bit 1	Boolean	-	-	7		H
54	Reserved Bit 2	Boolean	-	-	0		33
55	Reserved Bit 3	Boolean	-	-	1	H	
56	Reserved Bit 4	Boolean	-	-	2	H	
57	Reserved Bit 5	Boolean	-	-	3	H	
58	Reserved Bit 6	Boolean	-	-	4	H	
59	Reserved Bit 7	Boolean	-	-	5	H	
60	Reserved Bit 8	Boolean	-	-	6	H	
61	Reserved Bit 9	Boolean	-	-	7	H	
62	Heat Data Exchange Element Command	uint16	0	32767	0-14	34-35	
63	Heat Data Exchange Element Value Command	uint32	See heat data exchange for min and max values		0-30	36-39	H

Pump Data Exchange

E-Flo iQ Advance Map 18E218					
Data Exchange (Pump)					
Command Value (base 10 decimal)	Name	Units/Format	Read/ Write	Min Value	Max Value
0	Pump Active Alarms	Bitfield	Read	0	2,147,483,647
1	Pump Active Deviations	Bitfield	Read	0	2,147,483,647
2	Pump Active Advisories	Bitfield	Read	0	2,147,483,647
3	Driver Resettable Cycles	xxxx Cycles	Read	0	2,147,483,647
4	Pump Resettable Cycles	xxxx Cycles	Read	0	2,147,483,647
5	Platen Resettable Cycles	xxxx Cycles	Read	0	2,147,483,647
6	Dispense Valve Resettable Cycles	xxxx Cycles	Read	0	2,147,483,647
7	Platen Valve Resettable Cycles	xxxx Cycles	Read	0	2,147,483,647
8	Driver Lifetime Cycles	xxxx Cycles	Read	0	2,147,483,647
9	Pump Lifetime Cycles	xxxx Cycles	Read	0	2,147,483,647
10	Platen Lifetime Cycles	xxxx Cycles	Read	0	2,147,483,647
11	Dispense Valve Lifetime Cycles	xxxx Cycles	Read	0	2,147,483,647
12	Platen Valve Lifetime Cycles	xxxx Cycles	Read	0	2,147,483,647
13	Pump Direction	Bit Number: 0: FIRST DOWN 1: UP 2: DOWN 3: TOP CHANGEOVER 4: BOT CHANGEOVER	Read	0	31
14	Average Motor Current	xx.xxx Amps	Read	0.000	25.000
15	Motor Temperature	xx deg C	Read	0	200
16	IGBT Board Temperature	xx deg C	Read	0	200
17	Bus Voltage	xxx.xx Volts	Read	0.00	350.00
18	Precharge Source	0 = Local 1 = Remote/Fieldbus	Read	0	1
19	Flowrate Source	0 = Local 1 = Remote/Fieldbus	Read	0	1
20	Delays Source	0 = Local 1 = Remote/Fieldbus	Read	0	1

Heat Data Exchange

E-Flo iQ Heat Data Exchange 18E224					
Note: the "x" in the command value corresponds to the desired zone to be read.					
Command Value (base 10 decimal)	Name	Units/Format	Read/ Write	Min Value	Max Value
0	AMZ Active Module Alarms	Bitfield	Read	0	2,147,483,647
1	AMZ Active Module Deviations	Bitfield	Read	0	2,147,483,647
2	AMZ Active Module Advisories	Bitfield	Read	0	2,147,483,647
3	I/O Daughter Board Active Module Alarms	Bitfield	Read	0	2,147,483,647
4	I/O Daughter Board Active Module Deviations	Bitfield	Read	0	2,147,483,647
5	I/O Daughter Board Active Module Advisories	Bitfield	Read	0	2,147,483,647
6	Drum Sizes	Enum Number: 0: 20 Liters 1: 200 Liters	Read/ Write	0	1
7	Heat Idle Timeout	xx hours	Read/ Write	0	24
8	Line Voltage, Leg #1	xxx.x Volts	Read	0.0	400.0
9	Line Voltage, Leg #2	xxx.x Volts	Read	0.0	400.0
A	Line Voltage, Leg #3	xxx.x Volts	Read	0.0	400.0
Transition to Zones					
z000	AMZ Active Zone #z Alarms	Bitfield	Read	0	2,147,483,647
z001	AMZ Active Zone #z Deviations	Bitfield	Read	0	2,147,483,647
z002	AMZ Active Zone #z Advisories	Bitfield	Read	0	2,147,483,647
z003	Zone #z Heat State	Bit Number: 0: Heat Zone Off 1: Heat Zone On 2. Heat Zone Warming up 3. Heat Zone At Temperature 4. Heat Zone is Heat Soaking 5. Heat Zone is in Setback 6. Heat Zone has a Deviation 7. Heat Zone has an Alarm	Read	0	127
z004	Zone #z Actual Temperature	xx.x deg C	Read	0	100.0
z005	Zone #z Actual Current Usage	xx.xxx A	Read	0.000	25.000
z006	Zone #z Actual Duty Cycle	xxx.xx %	Read	0.00	100.00
z007	Zone #z Soak Time Remaining	xx seconds	Read	0	7200
z008	Zone #z Setpoint Temperature	xx.x deg C	Read/ Write	15	70.0
z009	Zone #z Setback Temperature	xx.x deg C	Read/ Write	15	70.0
z00A	Zone #z Heat Soak Time	xx.x minutes	Read/ Write	0	120
z00B	Zone #z Heat Enabled/ Installed State	boolean	Read/ Write	0	1

E-Flo iQ Heat Data Exchange 18E224					
Note: the “x” in the command value corresponds to the desired zone to be read.					
Command Value (base 10 decimal)	Name	Units/Format	Read/ Write	Min Value	Max Value
z00C	Zone #z Other Tandem Heat Enabled/Installed State	boolean	Read/ Write	0	1
z00D	Zone #z Type State	Enum Number: 0: Hose 1: Valve 2: Manifold 3: PGM 4: Flowmeter 5: Press Regulator 6: Other 7: Pump 8: Platen	Read/ Write	0	8
z00E	Zone #z High Temperature Alarm Offset	xx.x deg C	Read/ Write	0	30.0
z00F	Zone #z High Temperature Deviation Offset	xx.x deg C	Read/ Write	0	30.0
z010	Zone #z Low Temperature Alarm Offset	xx.x deg C	Read/ Write	0	30.0
z011	Zone #z Low Temperature Deviation Offset	xx.x deg C	Read/ Write	0	30.0

Pump Error Codes

Pump Active Alarms Bitfield		
Bit Number	Alarm Code	Alarm Name
0	V1M_	Low Voltage P_
1	V4M_	High Voltage P_
2	T4M_	High Motor Temperature P_
3	T4J_	High Controls Temperature P_
4	WBD_	Encoder Hardware P_
5	WMN_	Software Mismatch P_
6	CCN_	Control Board P_
7	A4N_	High Motor Current P_
8	WMC_	Control Board P_
9	A4J_	High Motor Current P_
10	DD4_	Pump Diving P_
11	P4C_	High Pressure P_
12	P1C_	Low Pressure P_
13	F4D_	High Flow Rate P_
14	F1D_	Low Flow Rate P_
15	P6D_	Outlet Pressure Sensor P_
16	DKC_	Crossover Error P_
17	L1C_	Drum Empty P_
18	DB1_	Pump Not Primed P_
19	CCG_	Fieldbus Comm. Error P_
20	CAC_	Display Comm. Error P_
21	P6V_	Valve Pressure Sensor P_
22	WSN_	Invalidated Style P_
23	WNC_	iQ Software Not Selected P_
24	WMH_	Control Board Off P_
25	-	Reserved
26	-	Reserved
27	-	Reserved
28	-	Reserved
29	-	Reserved
30	-	Reserved
31	-	Reserved

Pump Active Deviations Bitfield		
Bit Number	Deviation Code	Deviation Name
0	T2J_	Motor Temperatures Sensor P_
1	T3J_	Temperature Cutback P_
2	WSC_	Encoder Calibration P_
3	DD3_	Pump Diving P_
4	P3C_	High Pressure P_
5	P2C_	Low Pressure P_
6	F3D_	High Flow Rate P_
7	F2D_	Low Flow Rate P_
8	P6D_	Outlet Pressure Sensor P_
9	L2C_	Drum Low P_
10	DB2_	Pump Not Primed P_
11	-	Reserved
12	-	Reserved
13	-	Reserved
14	-	Reserved
15	-	Reserved
16	-	Reserved
17	-	Reserved
18	-	Reserved
19	-	Reserved
20	-	Reserved
21	-	Reserved
22	-	Reserved
23	-	Reserved
24	-	Reserved
25	-	Reserved
26	-	Reserved
27	-	Reserved
28	-	Reserved
29	-	Reserved
30	-	Reserved
31	-	Reserved

Pump Active Advisories Bitfield		
Bit Number	Advisory Code	Advisory Name
0	MBD_	Maint. Due Driver P_
1	MAD_	Maint. Due Pump P_
2	MLC_	Rebuild Platen Seals P_
3	MG2_	Low Filter Pressure P_
4	MG3_	High Filter Pressure P_
5	MLD_	Maint. Due Platen Valve P_
6	MED_	Maint. Due Dispense Valve P_
7	-	Reserved
8	-	Reserved
9	-	Reserved
10	-	Reserved
11	-	Reserved
12	-	Reserved
13	-	Reserved
14	-	Reserved
15	-	Reserved
16	-	Reserved
17	-	Reserved
18	-	Reserved
19	-	Reserved
20	-	Reserved
21	-	Reserved
22	-	Reserved
23	-	Reserved
24	-	Reserved
25	-	Reserved
26	-	Reserved
27	-	Reserved
28	-	Reserved
29	-	Reserved
30	-	Reserved
31	-	Reserved

Heat Error Codes

AMZ Active Module Alarms Bitfield		
Bit Number	Alarm Code	Alarm Name
0	V6H_	Wiring Error H_
1	V4H_	High Voltage H_
2	-	Reserved
3	-	Reserved
4	-	Reserved
5	-	Reserved
6	-	Reserved
7	-	Reserved
8	-	Reserved
9	-	Reserved
10	-	Reserved
11	-	Reserved
12	-	Reserved
13	-	Reserved
14	-	Reserved
15	-	Reserved
16	-	Reserved
17	-	Reserved
18	-	Reserved
19	-	Reserved
20	-	Reserved
21	-	Reserved
22	-	Reserved
23	-	Reserved
24	-	Reserved
25	-	Reserved
26	-	Reserved
27	-	Reserved
28	-	Reserved
29	-	Reserved
30	-	Reserved
31	-	Reserved

AMZ Active Module Deviation Bitfield		
Bit Number	Deviation Code	Deviation Name
0	V2H_	Low Voltage H_
1	-	Reserved
2	-	Reserved
3	-	Reserved
4	-	Reserved
5	-	Reserved
6	-	Reserved
7	-	Reserved
8	-	Reserved
9	-	Reserved
10	-	Reserved
11	-	Reserved
12	-	Reserved
13	-	Reserved
14	-	Reserved
15	-	Reserved
16	-	Reserved
17	-	Reserved
18	-	Reserved
19	-	Reserved
20	-	Reserved
21	-	Reserved
22	-	Reserved
23	-	Reserved
24	-	Reserved
25	-	Reserved
26	-	Reserved
27	-	Reserved
28	-	Reserved
29	-	Reserved
30	-	Reserved
31	-	Reserved

AMZ Active Module Advisories Bitfield		
Bit Number	Advisory Code	Advisory Name
0	-	Reserved
1	-	Reserved
2	-	Reserved
3	-	Reserved
4	-	Reserved
5	-	Reserved
6	-	Reserved
7	-	Reserved
8	-	Reserved
9	-	Reserved
10	-	Reserved
11	-	Reserved
12	-	Reserved
13	-	Reserved
14	-	Reserved
15	-	Reserved
16	-	Reserved
17	-	Reserved
18	-	Reserved
19	-	Reserved
20	-	Reserved
21	-	Reserved
22	-	Reserved
23	-	Reserved
24	-	Reserved
25	-	Reserved
26	-	Reserved
27	-	Reserved
28	-	Reserved
29	-	Reserved
30	-	Reserved
31	-	Reserved

I/O Daughter Board Active Module Alarms Bitfield		
Bit Number	Alarm Code	Alarm Name
0	TA1_	Heat Zone Offline Z1 H_
1	TA2_	Heat Zone Offline Z2 H_
2	TA3_	Heat Zone Offline Z3 H_
3	TA4_	Heat Zone Offline Z4 H_
4	TA5_	Heat Zone Offline Z5 H_
5	TA6_	Heat Zone Offline Z6 H_
6	TA7_	Heat Zone Offline Z7 H_
7	TA8_	Heat Zone Offline Z8 H_
8	TA9_	Heat Zone Offline Z9 H_
9	TAA_	Heat Zone Offline Z10 H_
10	CCH_	Fieldbus Comm. Error H_
11	-	Reserved
12	-	Reserved
13	-	Reserved
14	-	Reserved
15	-	Reserved
16	-	Reserved
17	-	Reserved
18	-	Reserved
19	-	Reserved
20	-	Reserved
21	-	Reserved
22	-	Reserved
23	-	Reserved
24	-	Reserved
25	-	Reserved
26	-	Reserved
27	-	Reserved
28	-	Reserved
29	-	Reserved
30	-	Reserved
31	-	Reserved

I/O Daughter Board Active Module Deviations Bitfield		
Bit Number	Deviation Code	Deviation Name
0	-	Reserved
1	-	Reserved
2	-	Reserved
3	-	Reserved
4	-	Reserved
5	-	Reserved
6	-	Reserved
7	-	Reserved
8	-	Reserved
9	-	Reserved
10	-	Reserved
11	-	Reserved
12	-	Reserved
13	-	Reserved
14	-	Reserved
15	-	Reserved
16	-	Reserved
17	-	Reserved
18	-	Reserved
19	-	Reserved
20	-	Reserved
21	-	Reserved
22	-	Reserved
23	-	Reserved
24	-	Reserved
25	-	Reserved
26	-	Reserved
27	-	Reserved
28	-	Reserved
29	-	Reserved
30	-	Reserved
31	-	Reserved

I/O Daughter Board Active Module Advisories Bitfield		
Bit Number	Advisory Code	Advisory Name
0	-	Reserved
1	-	Reserved
2	-	Reserved
3	-	Reserved
4	-	Reserved
5	-	Reserved
6	-	Reserved
7	-	Reserved
8	-	Reserved
9	-	Reserved
10	-	Reserved
11	-	Reserved
12	-	Reserved
13	-	Reserved
14	-	Reserved
15	-	Reserved
16	-	Reserved
17	-	Reserved
18	-	Reserved
19	-	Reserved
20	-	Reserved
21	-	Reserved
22	-	Reserved
23	-	Reserved
24	-	Reserved
25	-	Reserved
26	-	Reserved
27	-	Reserved
28	-	Reserved
29	-	Reserved
30	-	Reserved
31	-	Reserved

AMZ Active Zone #z Alarms Bitfield		
Bit Number	Alarm Code	Alarm Name
0	T4__	High Temperature H_Z_
1	T4__	High Temperature H_Z_
2	T1__	Low Temperature H_Z_
3	T8__	No Temperature Rise H_Z_
4	T4__	High Temperature H_Z_
5	A4__	High Current H_Z_
6	A1__	Low Current H_Z_
7	A8__	No Current H_Z_
8	A7__	Unexpected Current H_Z_
9	T6__	Sensor Error H_Z_
10	-	Reserved
11	-	Reserved
12	-	Reserved
13	-	Reserved
14	-	Reserved
15	-	Reserved
16	-	Reserved
17	-	Reserved
18	-	Reserved
19	-	Reserved
20	-	Reserved
21	-	Reserved
22	-	Reserved
23	-	Reserved
24	-	Reserved
25	-	Reserved
26	-	Reserved
27	-	Reserved
28	-	Reserved
29	-	Reserved
30	-	Reserved
31	-	Reserved

AMZ Active Zone #z Deviations Bitfield		
Bit Number	Deviation Code	Deviation Name
0	-	Reserved
1	-	Reserved
2	-	Reserved
3	-	Reserved
4	-	Reserved
5	-	Reserved
6	-	Reserved
7	-	Reserved
8	-	Reserved
9	-	Reserved
10	-	Reserved
11	-	Reserved
12	-	Reserved
13	-	Reserved
14	-	Reserved
15	-	Reserved
16	-	Reserved
17	-	Reserved
18	-	Reserved
19	-	Reserved
20	-	Reserved
21	-	Reserved
22	-	Reserved
23	-	Reserved
24	-	Reserved
25	-	Reserved
26	-	Reserved
27	-	Reserved
28	-	Reserved
29	-	Reserved
30	-	Reserved
31	-	Reserved

AMZ Active Zone #x Advisories		
Bit Number	Advisory Code	Advisory Name
0	T3__	High Temperature H_Z_
1	T3__	High Temperature H_Z_
2	T2__	Low Temperature H_Z_
3	-	Reserved
4	A3__	High Current H_Z_
5	A2__	Low Current H_Z_
6	-	Reserved
7	-	Reserved
8	-	Reserved
9	-	Reserved
10	-	Reserved
11	-	Reserved
12	-	Reserved
13	-	Reserved
14	-	Reserved
15	-	Reserved
16	-	Reserved
17	-	Reserved
18	-	Reserved
19	-	Reserved
20	-	Reserved
21	-	Reserved
22	-	Reserved
23	-	Reserved
24	-	Reserved
25	-	Reserved
26	-	Reserved
27	-	Reserved
28	-	Reserved
29	-	Reserved
30	-	Reserved
31	-	reserved

Prime Diagram

Prime

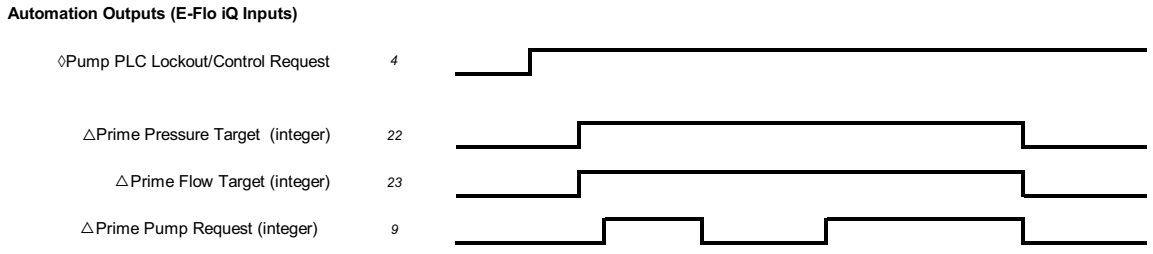
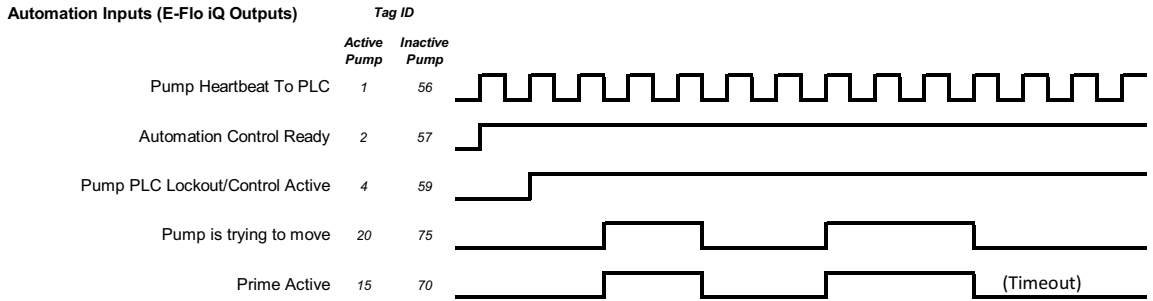

Can all be enabled at once.

Notes:

- △ If the unit is a Tandem unit, the priming can **only** be done on the inactive pump.
- ◇ When in Tandem mode, sending this Automation Output bit will result in the information being sent to both active and inactive pumps.

Depressurize Diagram

Depressurization

Dispense Valve Depressurization

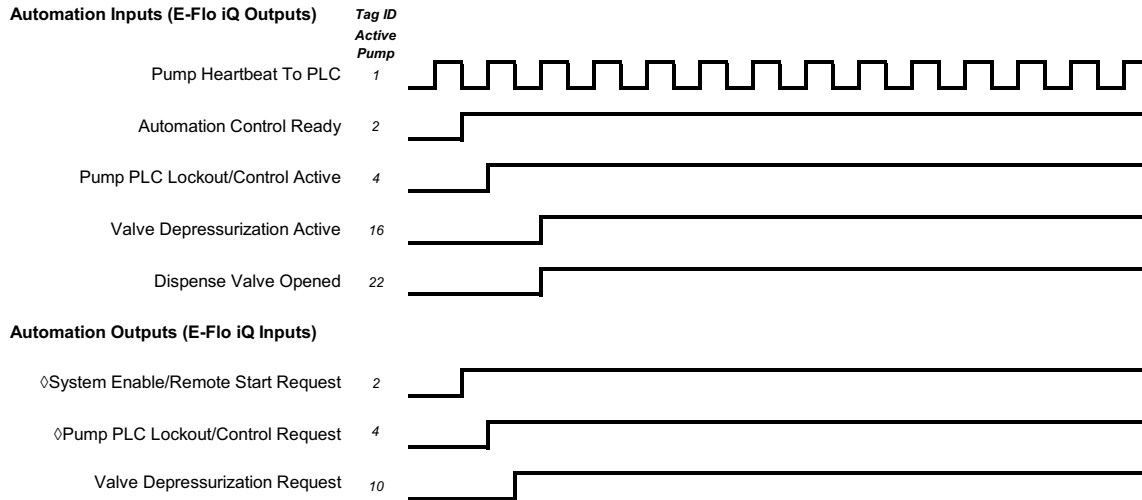

Platen Valve Depressurization

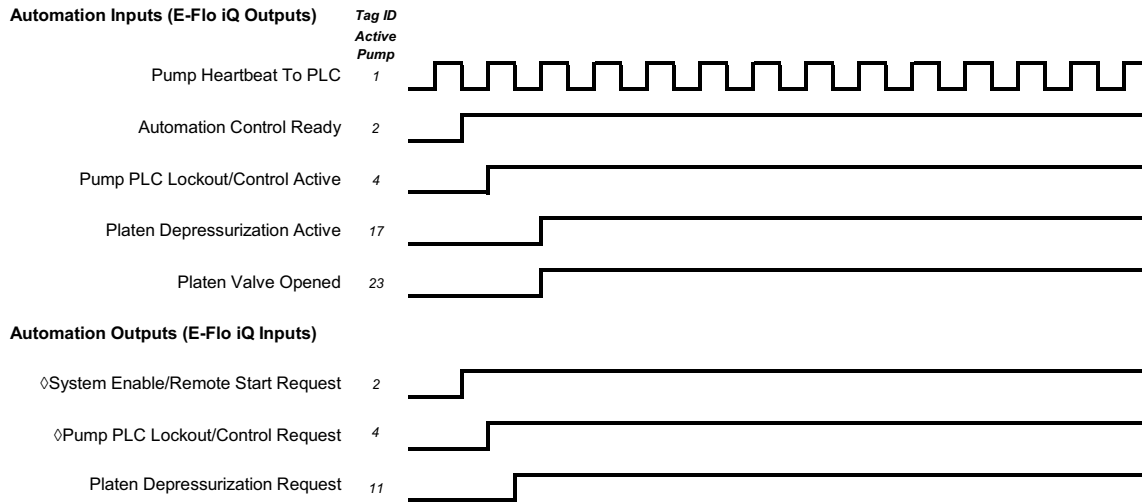

Notes:

- ◇ When in Tandem mode, sending this Automation Output bit will result in the information being sent to both active and inactive pumps.

System Enable - Remote Start Diagram

System Enable-Remote Start

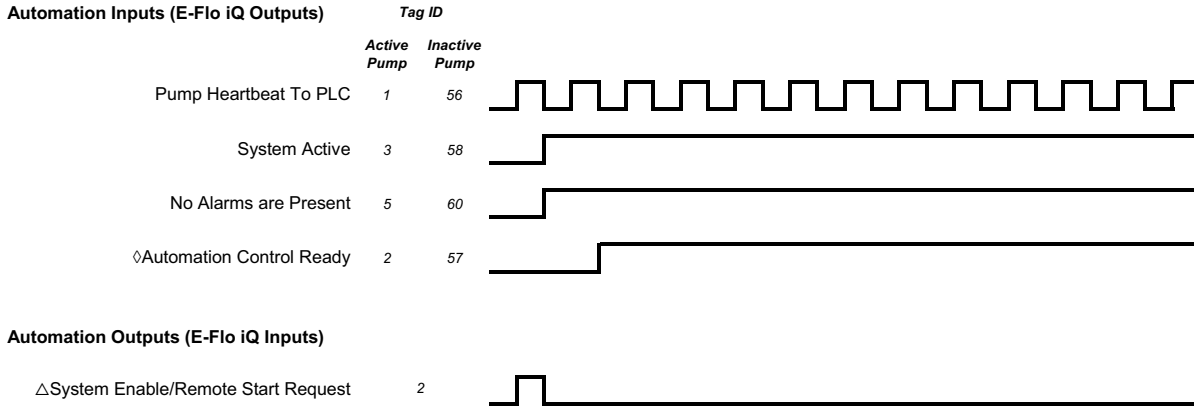

Note:

- ◇ The system must be in remote mode and the pump is enabled with no alarms.
- △ When in Tandem mode, sending this Automation Output bit will result in the information being sent to both active and inactive pumps.

Acknowledge - Clear Error Diagram

Ack-Clear Error

Alarms

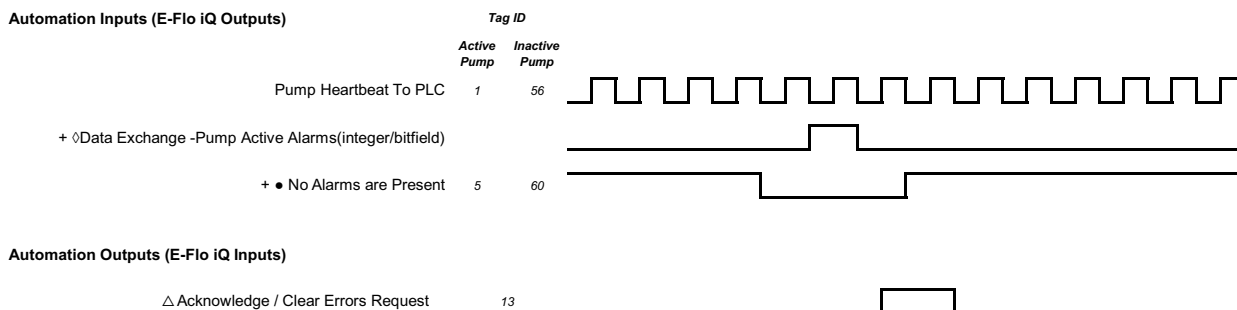

Deviations

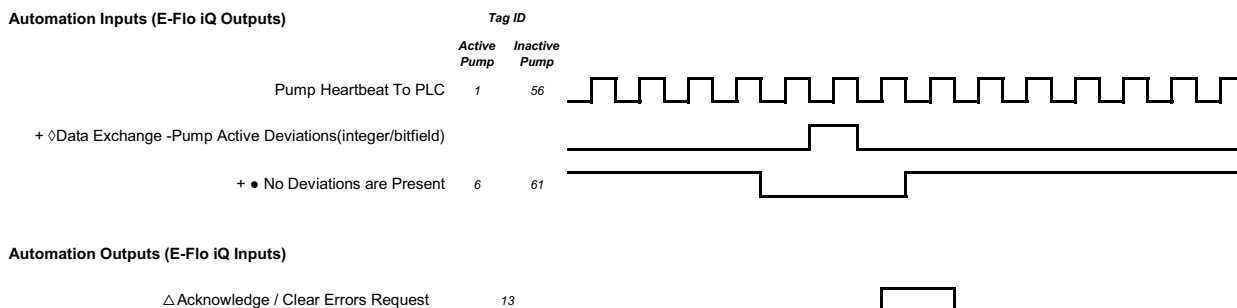

Advisories

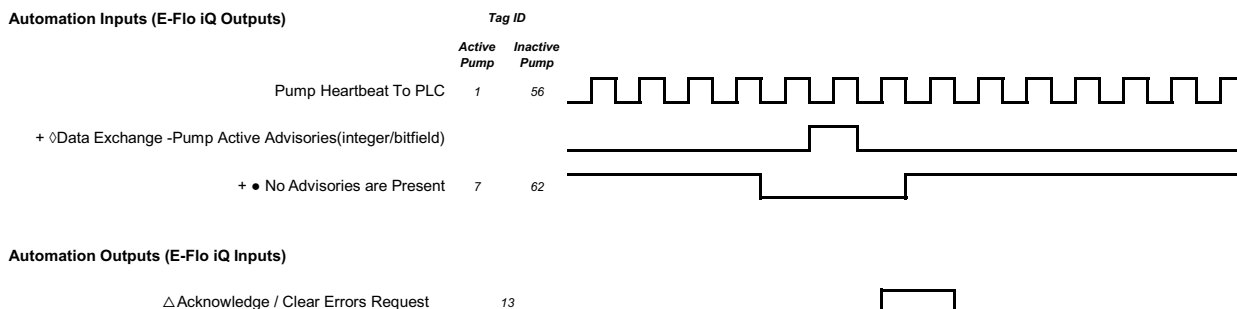

Notes:

- + Each pump has to be checked for errors. If there is an error, the corresponding error bitfield has to be pulled before sending the Acknowledge/clear errors bit.
- If errors are not successfully resolved the bit will remain high, once the system has successfully seen that the error has been resolved, the bit will go low.
- ◊ Use the Pump CGM Data Exchange Timing Diagram along with the corresponding command in the heat data exchange list to get the current error bitfield. Once the current bitfield is pulled, use the corresponding pump error code bitfield to decode which errors are active.
- △ When in Tandem mode, sending this Automation Output bit will result in the information being sent to both active and inactive pumps.

Manual Crossover Diagram

Manual Cross Over

Tandem Systems Only

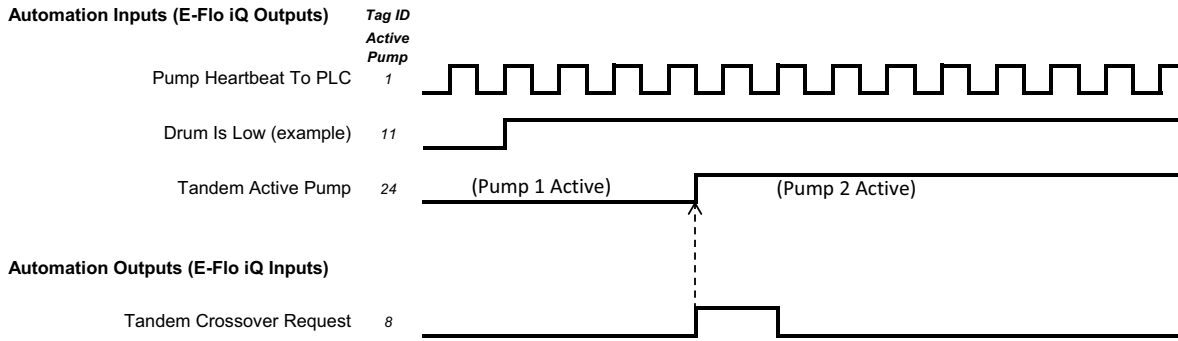

Data Exchange Diagram

Data Exchange

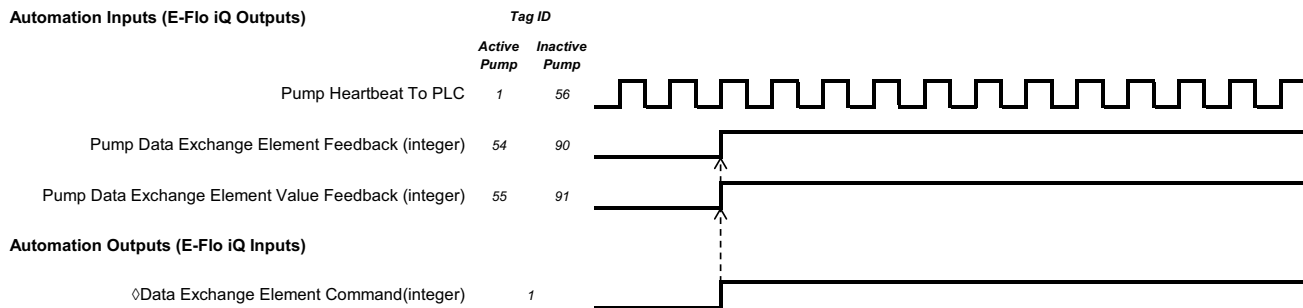

Notes:

- ◇ When in Tandem mode, sending the Automation Output will result in the information being sent to both active and inactive pumps.

Power Reset Diagram

Power Reset

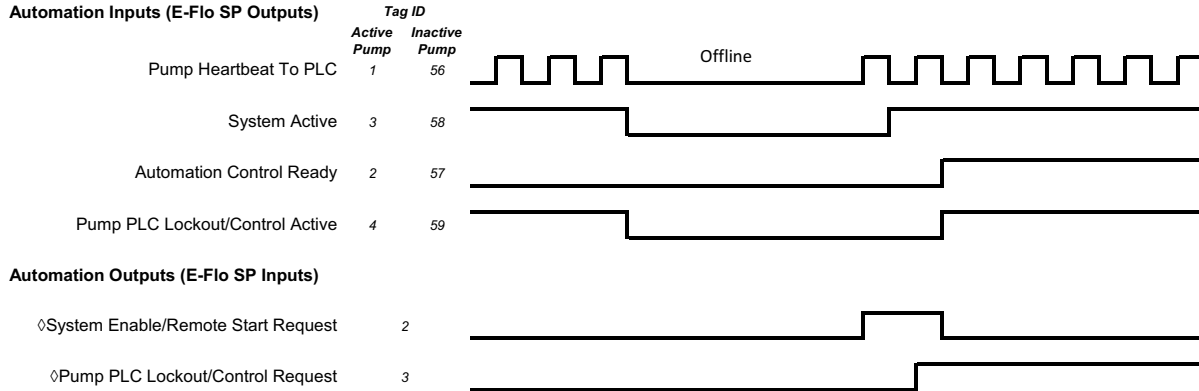

- Notes:**
- ◇ When in Tandem mode, sending the Automation Output will result in the information being sent to both active and inactive pumps.

Heat CGM Timing Diagram

Heat CGM Timing

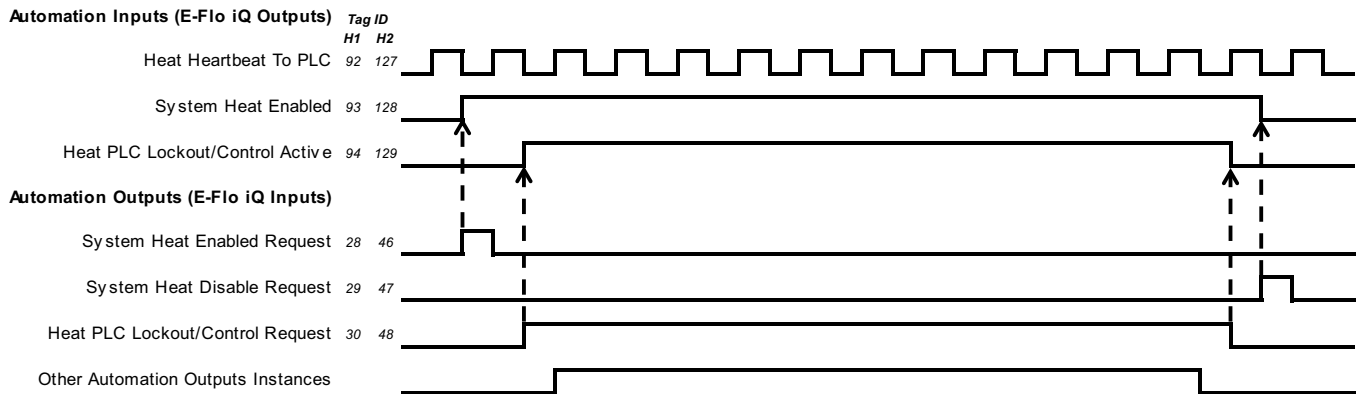

- Notes:**
- "System Heat Enabled Request", "System Heat Disable Request" and "Heat Module Data Exchange Desired Element" will be accepted without the "Heat PLC Lockout/Control" set high, any other Automation Outputs Instance needs to have the "Heat PLC Lockout/Control" set high for the Automation Output Instance to be accepted by the iQ Heat Controller
 - Other Automation Output Instances includes, "Heat On Request", "Heat Off Request", "Heat Setback Request", "Acknowledge/Clear Heat Errors", and "Heat Module Data Exchanged Desired Element Value"

Heat Module Acknowledge-Clear Error Diagram

Heat Module Ack-Clear Error

Alarms

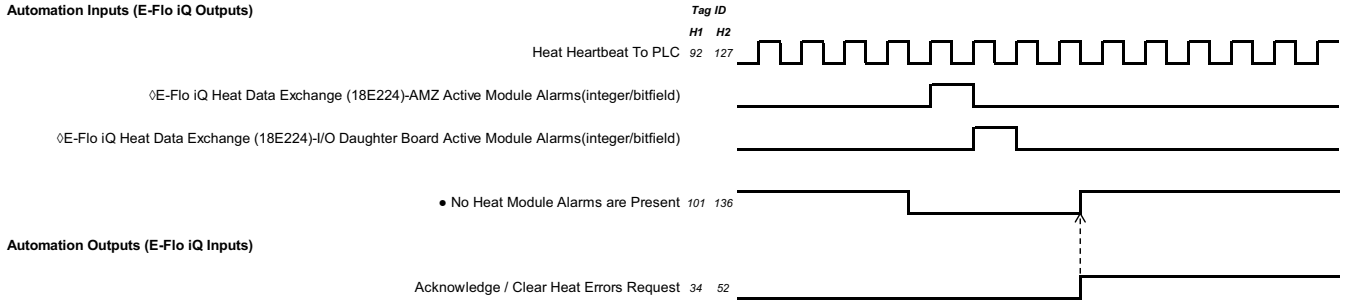

Deviations

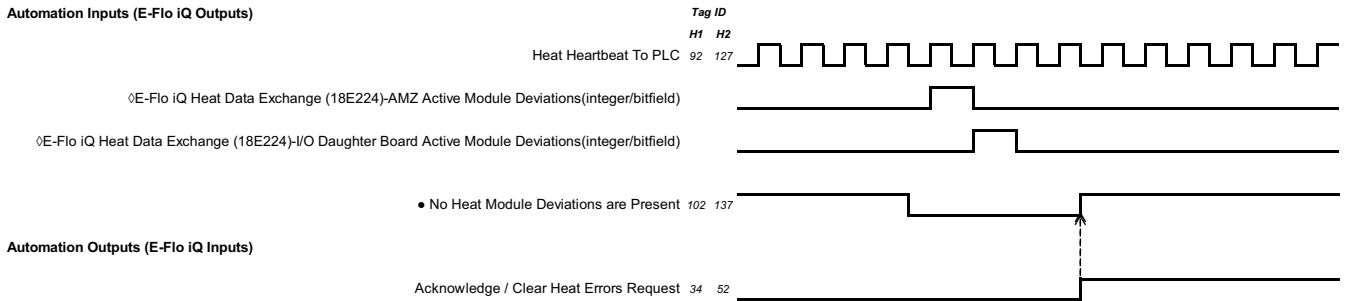

Advisories

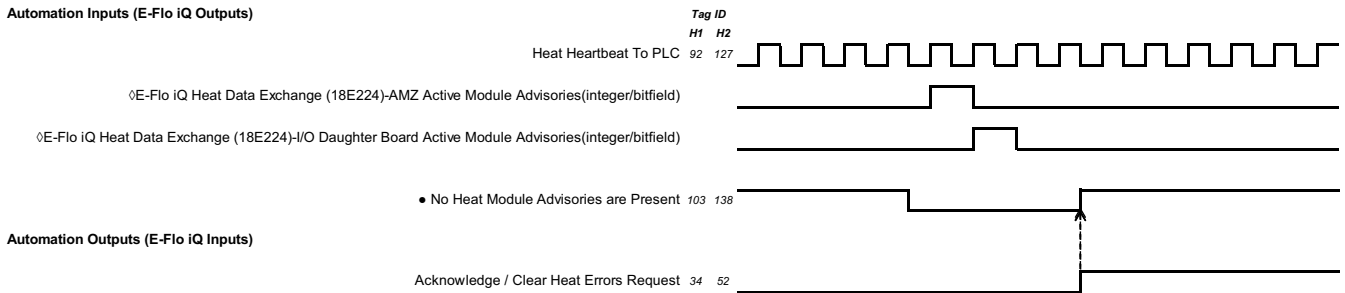

Notes:

- If errors are not successfully resolved/fixes the bit will remain high, once the system has successfully seen that the error has been resolved, the bit will go low
- ◊ Use the Heat CGM Data Exchange Timing Diagram along with the corresponding command in the heat data exchange list to get the current error bitmask. Once current bitmask is pulled, use the corresponding heat error code bitmask to decode which errors are active.

Heat Zone Acknowledge-Clear Error Diagram

Heat Zone Ack-Clear Error

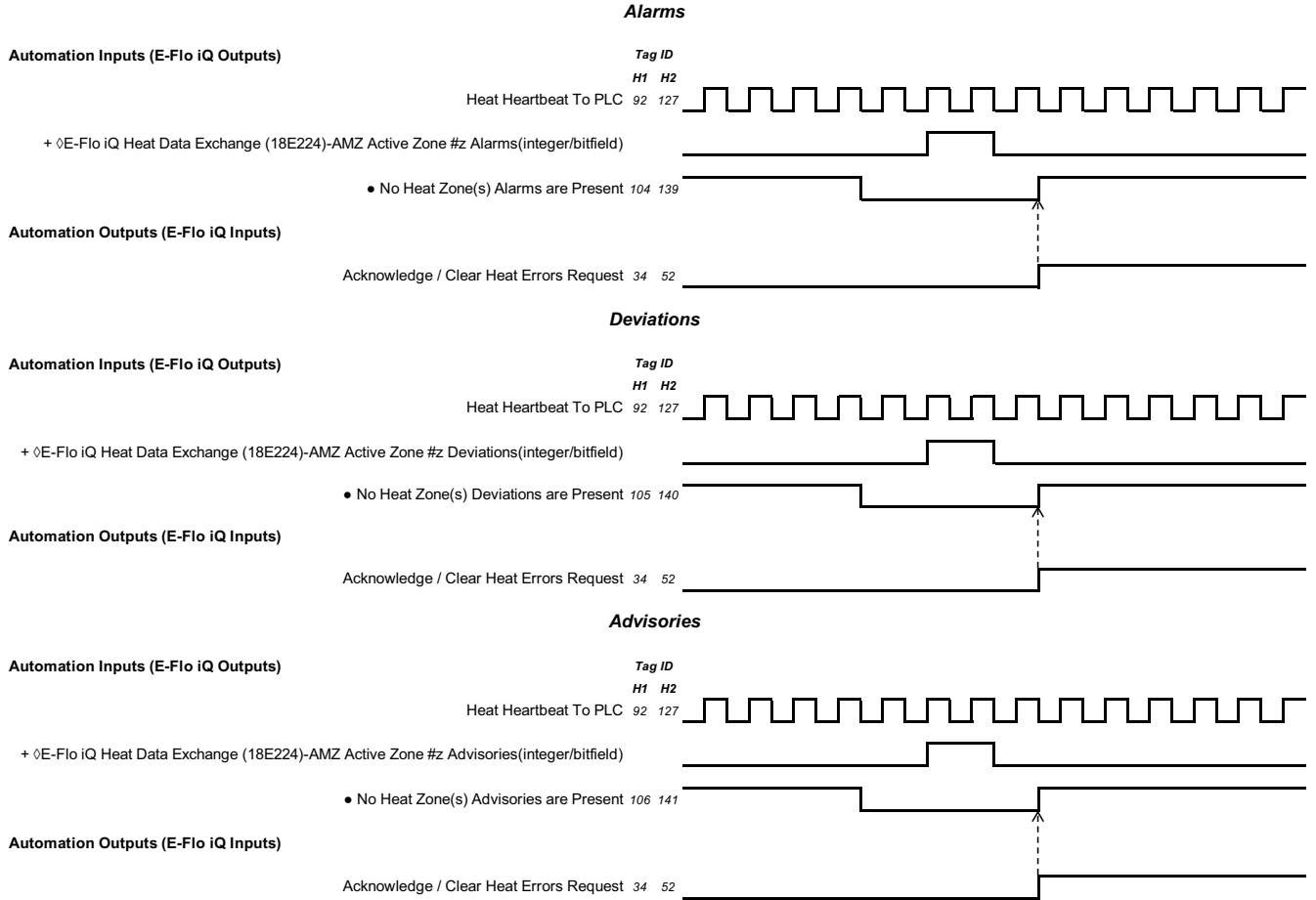

Notes:

- + Each zone has to be scanned for errors before send the Acknowledge/clear errors bit
- If errors are not successfully resolved/fixd the bit will reminder high, once the system has successfully seen that the error has been resolved, the bit will go low
- ◊ Use the Heat CGM Data Exchange Timing Diagram along with the corresponding command in the heat data exchange list to get the current error bitfield. Once current bitfield is pulled, use the corresponding heat error code bitfield to decode which errors are active.

Heat CGM Data Exchange Diagram

Heat CGM Data Exchange

Automation Inputs (E-Flo iQ Outputs)



Automation Outputs (E-Flo iQ Inputs)



Note:

* Important, ensure that desired element is set before changing the desired element value.

Connection Details

Fieldbus

Connect cables to the fieldbus per fieldbus standards.

PROFINET

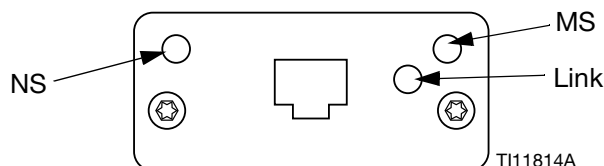

The EtherNet interface operates at 100M bit, full duplex, as required by PROFINET. The EtherNet interface is auto-polarity sensing and auto-crossover capable.

Network Status (NS)

State	Description	Comments
Off	Off-line	<ul style="list-style-type: none"> No power No connection with IO Controller
Green	On-line, (RUN)	<ul style="list-style-type: none"> Connection with IO Controller established IO Controller with RUN state
Flashing Green	On-line, (STOP)	<ul style="list-style-type: none"> Connection with IO Controller established IO Controller in STOP state

Module Status (MS)

State	Description	Comments
Off	Not initialized	No power or module in "SETUP" or "NW_INIT" state
Green	Normal operation	Diagnostic event(s) present
Flashing Green	Initialized, diagnostic event(s) present	Used by engineering tools to identify node on network
Red	Exception error	Module in state "EXCEPTION"
Red (1 flash)	Configuration error	Expected Identification differs from Real Identification
Red (2 flashes)	IP Address not set	Set IP address via system monitor or DNS server
Red (3 flashes)	Station Name not set	Set Station Name via system monitor
Red (4 flashes)	Major Internal Error	Cycle system power; replace module

Link/Activity (Link)

State	Description
Off	No Link, no communication present
Green	Link established, no communication present
Green, flashing	Link established, communication present

EtherNet/IP

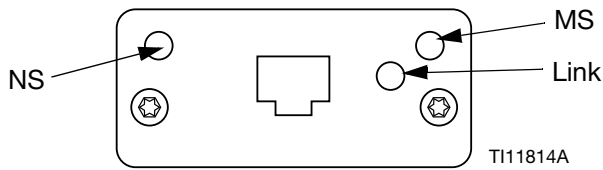

The Ethernet interface operates at 100Mbit, full duplex, as required by PROFINET. The Ethernet interface is auto-polarity sensing and auto-crossover capable.

Network Status (NS)

State	Description
Off	No power or no IP address
Green	On-line, one or more connections established (CIP Class 1 or 3)
Flashing Green	On-line, no connections established
Red	Duplicate IP address, FATAL error
Flashing Red	One or more connections timed out (CIP Class 1 or 3)

Module Status (MS)

State	Description
Off	No power
Green	Controlled by a Scanner in Run state
Flashing Green	Not configured, or Scanner in Idle state
Red	Major fault (EXCEPTION-state, FATAL error etc.)
Flashing Red	Recoverable fault(s)

LINK/Activity (Link)

State	Description
Off	No link, no activity
Green	Link established
Flashing Green	Activity

DeviceNet

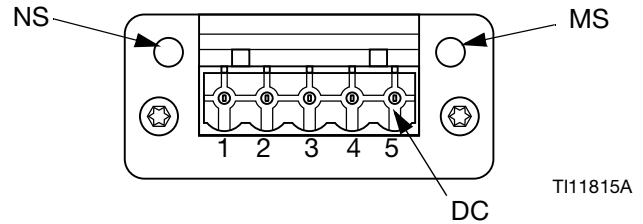

Network Status (NS)

State	Description
Off	Not online / No power
Green	On-line, one or more connections are established
Flashing Green (1 Hz)	On-line, no connections established
Red	Critical link failure
Flashing Red (1 Hz)	One or more connections timed-out
Alternating Red/Green	Self test

Module Status (MS)

State	Description
Off	No power or not initialized
Green	Initialized
Flashing Green (1 Hz)	Missing or incomplete configuration, device needs commissioning
Red	Unrecoverable Fault(s)
Flashing Red (1 Hz)	Recoverable Fault(s)
Alternating Red/Green	Self test

DeviceNet Connector (DC)

Pin	Signal	Description
1	V-	Negative bus supply voltage
2	CAN_L	CAN low bus line
3	SHIELD	Cable shield
4	CAN_H	CAN high bus line
5	V+	Positive bus supply voltage

PROFIBUS

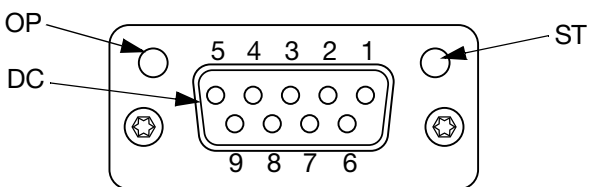

TI11816A

Operation Mode (OP)

State	Description
Off	Not online / No power
Green	On-line, data exchange
Flashing Green	On-line, clear
Flashing Red (1 flash)	Parameterization error
Flashing Red (2 flashes)	PROFIBUS Configuration error

Status Mode (ST)

State	Description
Off	No power or not initialized
Green	Initialized
Flashing Green	Initialized, diagnostic event(s) present
Red	Exception error

PROFIBUS Connector (DC)

Pin	Signal	Description
1	-	-
2	-	-
3	B Line	Positive RxD/TxD, RS485 level
4	RTS	Request to send
5	GND Bus	Ground (isolated)
6	+5V Bus Output	+5V termination power (isolated)
7	-	-
8	A Line	Negative RxD/TxD, RS485 level
9	-	-
Housing	Cable Shield	Internally connected to the Anybus protective earth via cable shield filters according to the PROFIBUS standard.

Gateway Setup Screens

Press the  soft key at the iQ Menu screen 2 to access the Fieldbus screens. The Fieldbus screens are shown only if a Fieldbus CGM is installed. If one is not installed, a Fieldbus Comm Error screen will be displayed.

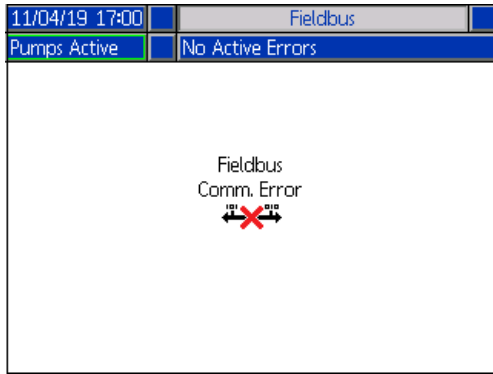

NOTE: The screens that will be shown here depend on the type of network you are using.

Some screens are informational only. For those that can be edited, press the  soft key to enter editing mode. Use the Directional Keypad (CH) and Numeric Keypad (CJ) to make changes.

PROFINET

PROFINET Screen 1

This screen allows you to set the IP Address, DHCP settings, Subnet Mask, Gateway, and DNS information.

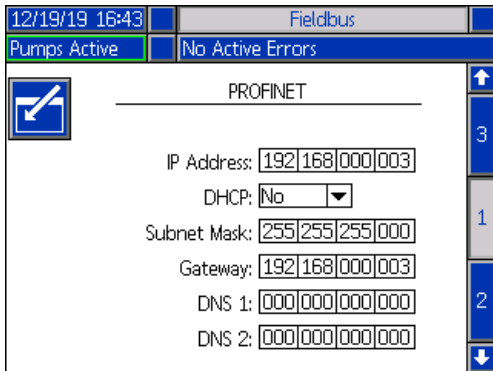

PROFINET Screen 2

This screen allows you to set the Station Name, Install Date, Location Tag, Function Tag, and Description.

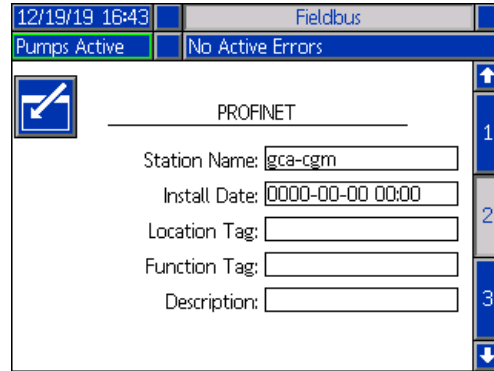

PROFINET Screen 3

This screen displays the Hardware Revision, System Serial number, and data map identification information.

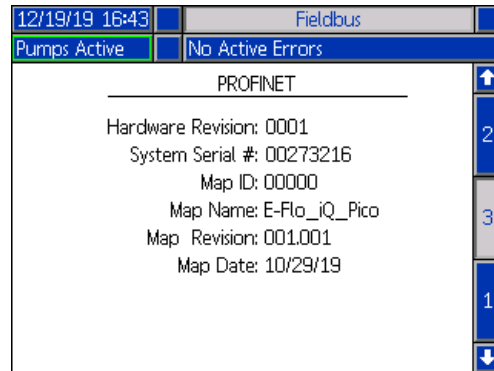

EtherNet/IP

EtherNet Screen 1

This screen allows you to set the IP Address, DHCP settings, subnet mask, gateway, and DNS information.

EtherNet Screen 2

You can view the Hardware Revision, System Serial number, and data map identification information at this screen.

PROFIBUS

PROFIBUS Screen 1

This screen allows you to set the Device Address, Install Date, Location Tag, Function Tag, and Description.

PROFIBUS Screen 2

You can view the Hardware Revision, System Serial number, and data map identification information at this screen.

DeviceNet

At this screen, you can set the Device Address and Baud Rate and view the Hardware Revision, System Serial number, and data map identification information



Integration Feedback Screens

Press the  soft key at the iQ Menu screen 2 to access the Integration Feedback screens. These are informational screens only. No changes can be made to the fields. See **Available Internal Data** on page 72.

Discrete Integration Screen

This screen shows the discrete integration robot signals that can be used when integrating the E-Flo iQ. The numbers to the right of each signal represent the connector and pin number on the E-Flo iQ driver. See **Connector Identification** on page 69. The colors to the left of the connector-pin numbers represent the wiring colors for the connection.

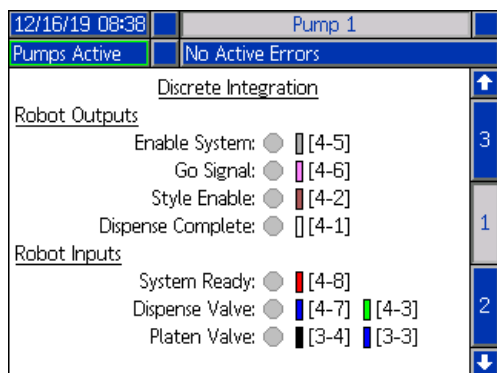

Fieldbus Integration Inputs Screen

This screen shows the status of the fieldbus integration robot input signals that can be used when integrating the E-Flo iQ.

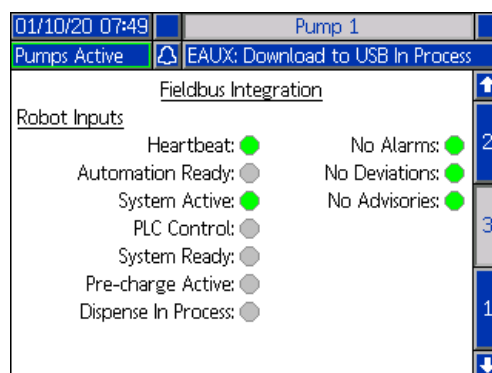

Fieldbus Integration Robot Outputs Screen

This screen shows the status of the fieldbus integration robot output signals that can be used when integrating the E-Flo iQ.

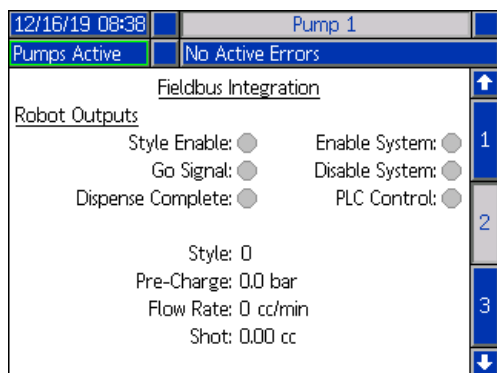

Technical Specifications

E-Flo iQ Dispense Systems		
	US	Metric
Maximum fluid operating temperature	158°F	70°C
Maximum working pressure	4000 psi	28 MPa, 276 bar
Maximum driver cycle rate	25 cycles per minute	
Air inlet size (supply system)	3/4 npt(f)	
Ambient operating temperature range (supply system)	32-120°F	0-49°C
Displacement pump effective area	See pump manual.	
Wetted parts	See component manual. See Related Manuals on page 3.	
Platen wetted materials		
25R096, 5 gal. (20 L)	Electroless nickel plated ductile iron, Neoprene, PTFE coated aluminum, 6061 aluminum, Buna, Viton, Zinc plated steel, 316 stainless steel, 17-4 stainless steel	
25R098, 5 gal. (20 L)	Electroless nickel plated ductile iron, Neoprene, PTFE coated aluminum, 6061 aluminum, Buna, Viton, Zinc plated steel, 316 stainless steel, 17-4 stainless steel	
25R097, 5 gal. (20 L)	Electroless nickel plated ductile iron, EPDM, PTFE coated aluminum, 6061 aluminum, Buna, Viton, Zinc plated steel, 316 stainless steel, 17-4 stainless steel	
25R099, 5 gal. (20 L)	Electroless nickel plated ductile iron, EPDM, PTFE coated aluminum, 6061 aluminum, Buna, Viton, Zinc plated steel, 316 stainless steel, 17-4 stainless steel	
255663, 55 gal. (200 L)	319 cast aluminum, EPDM, zinc plated carbon steel, 316 stainless steel, 17-4 stainless steel	
255664, 55 gal. (200 L)	319 cast aluminum, neoprene, zinc plated carbon steel, 316 stainless steel, 17-4 stainless steel	
Sound pressure, measured per EN ISO 11202:2010		
Normal operation (dispensing)	< 70 dBA	
Drum Change	77 dBA	
Electrical requirements		
Ambient system electrical ratings	200-240 VAC, 1 phase, 50/60 Hz, 20 A	
Heated system electrical ratings	200-240 VAC, 1 phase, 50/60 Hz, 60 A	
	200-240/400 VAC, 3 phase, 50/60 Hz, 38 A	
	380-420 VAC, 3 phase (YN), 50/60 Hz, 38 A	
Fluid outlet size		
Check-Mate 200	1 in. NPT female	
Maximum air input pressure (supply system)		
D60 - 3 in. dual post, 5 gal. (20 L)	150 psi	1.0 MPa, 10 bar
D200 - 3 in. dual post, 55 gal. (200 L)	150 psi	1.0 MPa, 10 bar
D200s - 6.5 in. dual post, 55 gal. (200 L)	125 psi	0.9 MPa, 9 bar

Recycling and Disposal

End of Product Life

At the end of a product's useful life, recycle it in a responsible manner. For additional information refer to the E-Flo iQ Dispense System Installation-Parts manual. See **Related Manuals** on page 3.

California Proposition 65

CALIFORNIA RESIDENTS

 **WARNING:** Cancer and reproductive harm – www.P65warnings.ca.gov.

Graco Standard Warranty

Graco warrants all equipment referenced in this document which is manufactured by Graco and bearing its name to be free from defects in material and workmanship on the date of sale to the original purchaser for use. With the exception of any special, extended, or limited warranty published by Graco, Graco will, for a period of twelve months from the date of sale, repair or replace any part of the equipment determined by Graco to be defective. This warranty applies only when the equipment is installed, operated and maintained in accordance with Graco's written recommendations.

This warranty does not cover, and Graco shall not be liable for general wear and tear, or any malfunction, damage or wear caused by faulty installation, misapplication, abrasion, corrosion, inadequate or improper maintenance, negligence, accident, tampering, or substitution of non-Graco component parts. Nor shall Graco be liable for malfunction, damage or wear caused by the incompatibility of Graco equipment with structures, accessories, equipment or materials not supplied by Graco, or the improper design, manufacture, installation, operation or maintenance of structures, accessories, equipment or materials not supplied by Graco.

This warranty is conditioned upon the prepaid return of the equipment claimed to be defective to an authorized Graco distributor for verification of the claimed defect. If the claimed defect is verified, Graco will repair or replace free of charge any defective parts. The equipment will be returned to the original purchaser transportation prepaid. If inspection of the equipment does not disclose any defect in material or workmanship, repairs will be made at a reasonable charge, which charges may include the costs of parts, labor, and transportation.

THIS WARRANTY IS EXCLUSIVE, AND IS IN LIEU OF ANY OTHER WARRANTIES, EXPRESS OR IMPLIED, INCLUDING BUT NOT LIMITED TO WARRANTY OF MERCHANTABILITY OR WARRANTY OF FITNESS FOR A PARTICULAR PURPOSE.

Graco's sole obligation and buyer's sole remedy for any breach of warranty shall be as set forth above. The buyer agrees that no other remedy (including, but not limited to, incidental or consequential damages for lost profits, lost sales, injury to person or property, or any other incidental or consequential loss) shall be available. Any action for breach of warranty must be brought within two (2) years of the date of sale.

GRACO MAKES NO WARRANTY, AND DISCLAIMS ALL IMPLIED WARRANTIES OF MERCHANTABILITY AND FITNESS FOR A PARTICULAR PURPOSE, IN CONNECTION WITH ACCESSORIES, EQUIPMENT, MATERIALS OR COMPONENTS SOLD BUT NOT MANUFACTURED BY GRACO. These items sold, but not manufactured by Graco (such as electric motors, switches, hose, etc.), are subject to the warranty, if any, of their manufacturer. Graco will provide purchaser with reasonable assistance in making any claim for breach of these warranties.

In no event will Graco be liable for indirect, incidental, special or consequential damages resulting from Graco supplying equipment hereunder, or the furnishing, performance, or use of any products or other goods sold hereto, whether due to a breach of contract, breach of warranty, the negligence of Graco, or otherwise.

FOR GRACO CANADA CUSTOMERS

The Parties acknowledge that they have required that the present document, as well as all documents, notices and legal proceedings entered into, given or instituted pursuant hereto or relating directly or indirectly hereto, be drawn up in English. Les parties reconnaissent avoir convenu que la rédaction du présente document sera en Anglais, ainsi que tous documents, avis et procédures judiciaires exécutés, donnés ou intentés, à la suite de ou en rapport, directement ou indirectement, avec les procédures concernées.

Graco Information

Sealant and Adhesive Dispensing Equipment

For the latest information about Graco products, visit www.graco.com.

For patent information, see www.graco.com/patents.

TO PLACE AN ORDER, contact your Graco distributor, go to www.graco.com, or call to identify the nearest distributor.

If calling from the USA: 1-800-746-1334

If calling from outside the USA: 0-1-330-966-3000

All written and visual data contained in this document reflects the latest product information available at the time of publication. Graco reserves the right to make changes at any time without notice.

Original instructions. This manual contains English. MM 333587

Graco Headquarters: Minneapolis

International Offices: Belgium, China, Japan, Korea

GRACO INC. AND SUBSIDIARIES • P.O. BOX 1441 • MINNEAPOLIS MN 55440-1441 • USA
Copyright 2020, Graco Inc. All Graco manufacturing locations are registered to ISO 9001.

www.graco.com
Revision E, October 2022