

InvisiPacTM Heated Hose

332072T
EN

For use with Graco InvisiPac systems. For professional use only.

Not approved for use in explosive atmospheres or hazardous locations.

1500 psi (10 MPa, 103 bar) Maximum Fluid Working Pressure

400° F (204° C) Maximum Hose Operating Temperature.

Available for dry or wash-down environments.

See page 2 for model information.



Important Safety Instructions

Read all warnings and instructions in this manual. Save these instructions.

! WARNING

The operating and safety features of these hoses are designed for use only with Graco InvisiPac systems. To reduce the risk of fire and serious injury, never connect these hoses to any other device.

Standard Style Shown



Contents

Contents	2	Parts	12
Standard Model Hoses	2	Heated Hose Instruction Tag, 120051	12
Water-wash Model Hoses	2	Heated Hose Warning Label, 196694	12
Warnings	3	Water-wash Heated Hose	
Overview	5	Instruction Tag, 17A202	12
Installation	6	Accessories	12
Pressure Relief Procedure	8	Self-Sealing Silicone Rubber Tape, 16Y938 (12 yd /	
Operation	8	11 m roll)	12
Maintenance	9	Hose Hanger Spring Kit, 253283	12
Washing Instructions	9	Technical Data	13
Troubleshooting	10	Graco Standard Warranty	14
		Graco Information	14

Standard Model Hoses

Standard model hoses are meant for dry environments only. Standard model hoses have a gray braided scuff guard.

Part No.	Length ft (m)	Hose Core Size	Swivel Fitting	Watts per foot
127401	4 (1.2)	No. 6 (0.308" ID)	0.31 ID (9/16-18 JIC(f))	60
127402	6 (1.8)	No. 6 (0.308" ID)	0.31 ID (9/16-18 JIC(f))	60
127404	8 (2.4)	No. 6 (0.308" ID)	0.31 ID (9/16-18 JIC(f))	60
126389	10 (3.0)	No. 6 (0.308" ID)	0.31 ID (9/16-18 JIC(f))	60
127405	12 (3.6)	No. 6 (0.308" ID)	0.31 ID (9/16-18 JIC(f))	60
127406	14 (4.2)	No. 6 (0.308" ID)	0.31 ID (9/16-18 JIC(f))	60
127407	16 (4.8)	No. 6 (0.308" ID)	0.31 ID (9/16-18 JIC(f))	60
127408	18 (5.4)	No. 6 (0.308" ID)	0.31 ID (9/16-18 JIC(f))	60
126483	20 (6.0)	No. 6 (0.308" ID)	0.31 ID (9/16-18 JIC(f))	60
127409	22 (6.7)	No. 6 (0.308" ID)	0.31 ID (9/16-18 JIC(f))	50
126534	25 (7.6)	No. 6 (0.308" ID)	0.31 ID (9/16-18 JIC(f))	50



Intertek
9902471

Conforms to UL 499
Certified to CSA C22.2 No. 88





Water-wash Model Hoses

Water-wash model hoses are meant for wash-down environments. Water-wash models have a black rubber scuff guard. Water-wash hoses are IPx6 rated.



Part No.	Length ft (m)	Hose Core Size	Swivel Fitting	Watts per foot
24U763	4 (1.2)	No. 6 (0.308" ID)	0.31 ID (9/16-18 JIC(f))	60
24U765	6 (1.8)	No. 6 (0.308" ID)	0.31 ID (9/16-18 JIC(f))	60
24U766	8 (2.4)	No. 6 (0.308" ID)	0.31 ID (9/16-18 JIC(f))	60
24U767	10 (3.0)	No. 6 (0.308" ID)	0.31 ID (9/16-18 JIC(f))	60
24U768	12 (3.6)	No. 6 (0.308" ID)	0.31 ID (9/16-18 JIC(f))	60
24U769	14 (4.2)	No. 6 (0.308" ID)	0.31 ID (9/16-18 JIC(f))	60
24U771	16 (4.8)	No. 6 (0.308" ID)	0.31 ID (9/16-18 JIC(f))	60
24U772	18 (5.4)	No. 6 (0.308" ID)	0.31 ID (9/16-18 JIC(f))	60
24U773	20 (6.0)	No. 6 (0.308" ID)	0.31 ID (9/16-18 JIC(f))	60
24U774	22 (6.7)	No. 6 (0.308" ID)	0.31 ID (9/16-18 JIC(f))	50
24U776	25 (7.6)	No. 6 (0.308" ID)	0.31 ID (9/16-18 JIC(f))	50

Warnings

The following warnings are for the setup, use, grounding, maintenance, and repair of this equipment. The exclamation point symbol alerts you to a general warning and the hazard symbols refer to procedure-specific risks. When these symbols appear in the body of this manual or on warning labels, refer back to these Warnings. Product-specific hazard symbols and warnings not covered in this section may appear throughout the body of this manual where applicable.

 WARNING	
	<p>ELECTRIC SHOCK HAZARD</p> <p>The hoses must be grounded. Improper grounding, set-up, or usage of hoses can cause electric shock.</p> <ul style="list-style-type: none"> • Turn off and disconnect power before installing or servicing hoses. • Connect only to grounded power source. • All electrical wiring must be done by a qualified electrician and comply with all local codes and regulations. • Never cut or puncture a hose cover. • Do not expose to rain. Store indoors. • Do not wash Standard hoses. Standard hoses are intended to be dry at all times. • Always follow the Washing Instructions in this manual for the Water-wash hoses.
	<p>SKIN INJECTION HAZARD</p> <p>High-pressure fluid from hose leaks, or ruptured components will pierce skin. This may look like just a cut, but it is a serious injury that can result in amputation. Get immediate surgical treatment.</p> <ul style="list-style-type: none"> • Inspect hose before each use for cuts, bulges, kinks or any other damage. • Replace damaged hose immediately. • Replace hoses proactively at regular intervals based on your operating conditions. • Tighten all fluid connections before operating the equipment. • Keep clear of leaks. • Do not stop or deflect leaks with your hand, body, glove, or rag. • Never exceed hose Maximum Pressure or Temperature ratings. • Only use chemicals that are compatible with wetted parts. See Technical Data in this manual. Read MSDSs and fluid and solvent manufacturer's recommendations. • Follow the Pressure Relief Procedure when you stop spraying/dispensing and before cleaning, checking, or servicing equipment.
	<p>BURN HAZARD</p> <p>Equipment surfaces and fluid that's heated can become very hot during operation. To avoid severe burns:</p> <ul style="list-style-type: none"> • Do not touch hot fluid or equipment.
	<p>TOXIC FLUID OR FUMES HAZARD</p> <p>Toxic fluids or fumes can cause serious injury or death if splashed in the eyes or on skin, inhaled, or swallowed.</p> <ul style="list-style-type: none"> • Read MSDSs to know the specific hazards of the fluids you are using. • Store hazardous fluid in approved containers, and dispose of it according to applicable guidelines. • Always wear chemically impermeable gloves when spraying, dispensing, or cleaning equipment.

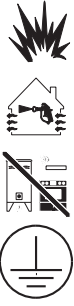
WARNING

	<p>FIRE AND EXPLOSION HAZARD</p> <p>Flammable fumes, such as solvent and paint fumes, in work area can ignite or explode. To help prevent fire and explosion:</p> <ul style="list-style-type: none"> • Use equipment only in well ventilated area. • Eliminate all ignition sources; such as pilot lights, cigarettes, portable electric lamps, and plastic drop cloths (potential static arc). • Keep work area free of debris, including solvent, rags and gasoline. • Do not plug or unplug power cords, or turn power or light switches on or off when flammable fumes are present. • Ground all equipment in the work area. See Grounding instructions. • Use only grounded hoses. • Hold gun firmly to side of grounded pail when triggering into pail. Do not use pail liners unless they are antistatic or conductive. • Stop operation immediately if static sparking occurs or you feel a shock. Do not use equipment until you identify and correct the problem. • Keep a working fire extinguisher in the work area.
	<p>EQUIPMENT MISUSE HAZARD</p> <p>Misuse can cause death or serious injury.</p> <ul style="list-style-type: none"> • Do not operate the unit when fatigued or under the influence of drugs or alcohol. • Do not exceed the maximum working pressure or temperature rating of the lowest rated system component. See Technical Data in all equipment manuals. • Use fluids and solvents that are compatible with equipment wetted parts. See Technical Data in all equipment manuals. Read fluid and solvent manufacturer's warnings. For complete information about your material, request MSDS from distributor or retailer. • Do not leave the work area while equipment is energized or under pressure. • Turn off all equipment and follow the Pressure Relief Procedure when equipment is not in use. • Check equipment daily. Repair or replace worn or damaged parts immediately with genuine manufacturer's replacement parts only. • Do not alter or modify equipment. Alterations or modifications may void agency approvals and create safety hazards. • Make sure all equipment is rated and approved for the environment in which you are using it. • Use equipment only for its intended purpose. Call your distributor for information. • Route hoses and cables away from traffic areas, sharp edges, moving parts, and hot surfaces. • Do not kink or over bend hoses or use hoses to pull equipment. • Keep children and animals away from work area. • Comply with all applicable safety regulations.
	<p>PERSONAL PROTECTIVE EQUIPMENT</p> <p>Wear appropriate protective equipment when in the work area to help prevent serious injury, including eye injury, hearing loss, inhalation of toxic fumes, and burns. This protective equipment includes but is not limited to:</p> <ul style="list-style-type: none"> • Protective eyewear, and hearing protection. • Respirators, protective clothing, and gloves as recommended by the fluid and solvent manufacturer.

Overview

Each hose assembly must be used with and controlled by a Graco temperature controller. See system manual for Graco temperature controller part number.

The heated hose maintains proper fluid temperature while dispensing. The hose has two electrical connectors with cables, each extending from the end of the hose.

The large round connector is the melter end and has 2 feet (0.6 m) of cable (see Fig. 1). The small round connector is the gun end and has 2 feet (0.6 m) of cable (see Fig. 2).

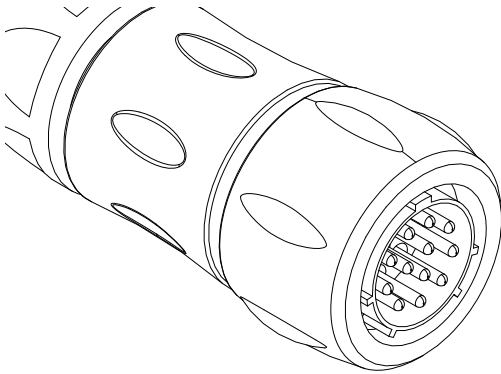

FIG. 1: Melter Connection

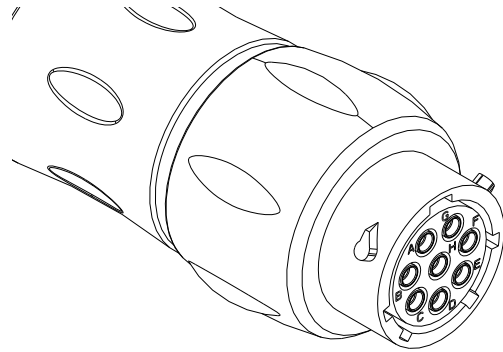

FIG. 2: Gun Connection

Installation

--	--	--	--	--	--	--

To reduce the risk of skin injection, follow the **Pressure Relief Procedure** on page 8 whenever you are instructed to relieve pressure.

--	--	--	--	--	--	--

To reduce the risk of electric shock, do not allow Standard hoses to come into contact with liquids of any kind. Only use Water-wash hoses with Water-wash cord sets and valves.

NOTE: Pressure check the hose assemblies. Refer to your system operation manual for priming and pressurizing the fluid hoses. Check carefully for leaks at the hose connections. If there are leaks, relieve the pressure as instructed on page 8. Tighten all hose connections and check for leaks by pressurizing the system.

NOTE: InvisiPac hose diameter may be larger than previously installed hose. Verify all items used during installation, including any re-used items such as hose supports, mounts, and hose routings, meet all of the following requirements.

1. Do not use hose to pull the equipment.

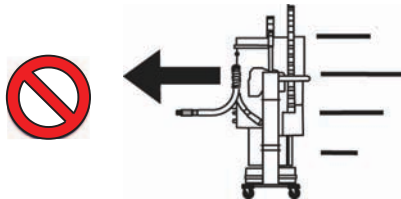

2. Use 2 wrenches to tighten. Torque to specification:

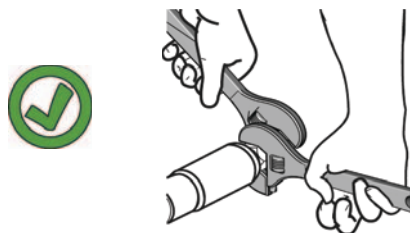

Torque	
Fitting	in-lb (N•m)
-6	300 (33.9)

3. Do not tape or cover hose.

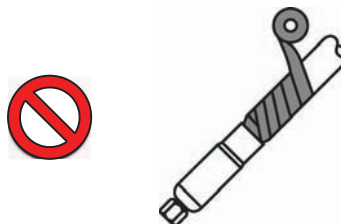

4. Do not flex hose when cold.

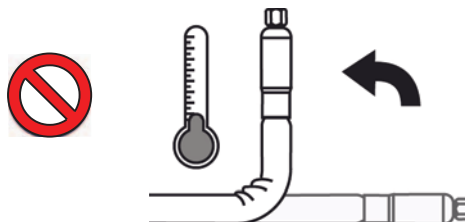

5. Use hose support spring.

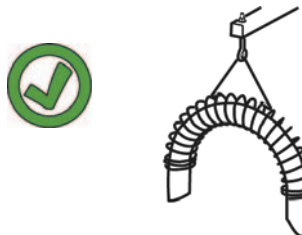

6. Do not clamp, squeeze, or zip tie hose.

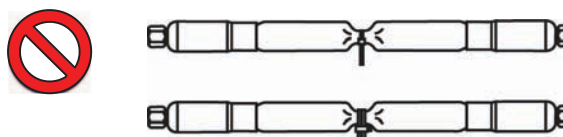

7. Minimum bend radius:

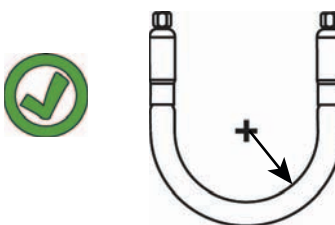

Fitting	Radius in. (mm)
-6	8 (203)

8. Do not bend or crimp hose.



9. Do not twist hose.



10. Use proper length hose.

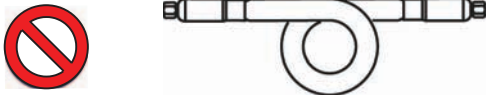
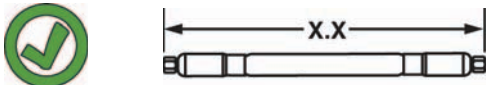

11. Minimum hose spacing.

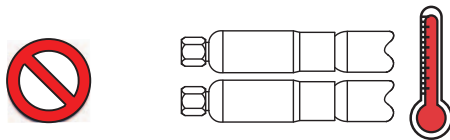
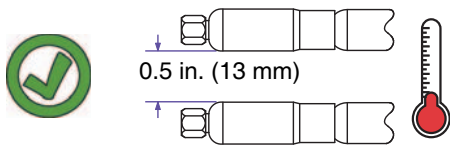

12. Provide protection against dripping, splashing, and seepage of liquids.

13. Connect the melter end connector to the Graco temperature controller by pushing the connector on the mating receptacle of the system and turning the threads until it is tight.

14. Connect the gun end connector to the hot melt manifold/dispense valve.

15. Avoid kinking and twisting the melter and gun connector cables. Route away from sharp edges and ensure that any straps or ties do not pinch the cables. Damage to internal wiring can result from improper handling.

16. Route and suspend hoses away from the ground, combustible materials, and damp surfaces.

For Water-wash hose only:

<p>To reduce the risk of electric shock, route the Water-wash hose so water cannot run back into the hotmelt control system.</p>						
<small>ti23415a</small>						

Pressure Relief Procedure

Operation

Refer to your system operation manual for complete startup and operating instructions.



This equipment stays pressurized until pressure is manually relieved. To help prevent serious injury from pressurized fluid, such as skin injection, splashing fluid and moving parts, follow the Pressure Relief Procedure when you stop spraying and before cleaning, checking, or servicing the equipment.

1. Turn off the power (air) to the InvisiPac System.
2. Hold a metal part of the gun firmly to the side of a grounded metal pail, then trigger the gun to relieve pressure.
3. *If you suspect that the dispense valve or hose is completely clogged, or that pressure has not been fully relieved after following the steps above, very slowly loosen the tip retaining nut or hose end coupling to relieve pressure gradually, then loosen completely. Wear protective gloves to avoid burns. Now clear the tip/nozzle or hose using a wire brush.*
4. Be sure the fluid is cool before disconnecting the hoses.

Maintenance



Do not mend or repair any part of a hose assembly. If the hose is damaged, replace it immediately to avoid serious injury from fluid injection and electric shock.

If the hose is not heating, be sure the connector at the hose control box is firmly plugged in. If that does not correct the problem, relieve the fluid pressure in the pump and hoses as instructed in your system operation manual. If the problem is not corrected, replace the hose. See **Troubleshooting** on page 10 for electrical measurements.

Washing Instructions (Water-wash Hoses only)



To help prevent serious injuries such as burns, skin injection, and electric shock, always perform the following before washing the hose:

- Disconnect power to InvisiPac System.
- Perform **Pressure Relief Procedure**, page 8.
- Allow hose to cool.

Clean hoses by spraying low pressure water onto the surface of the hose. The hoses are not intended to be immersed or submerged.

NOTE: Water-wash hoses are IPx6 rated.

NOTICE

Do not immerse or submerge any part of the hose. Damage to equipment can occur.

The diagram illustrates two methods of cleaning a hose. The top method shows a green checkmark icon next to a hose being sprayed with water droplets, indicating this is the correct procedure. The bottom method shows a red prohibition sign (a circle with a diagonal line) next to a hose submerged in a tank of water, indicating that immersion or submersion is prohibited.

ti23414a

Troubleshooting



1. **Check the continuity of the hose components to verify proper resistance of the heater cable.**
 - a. Use an ohmmeter to check the electrical resistance at the heating element pins between pins C and D of the melter end connector that attaches to the heated hose control. See FIG. 1. The resistance of the heating element for the various lengths of coupled hose assemblies is given in the following coupled hose chart.

Part	Length ft (m)	Pins C & D Resistance (ohms) +/- 10%
127401, 24U763	4 (1.2)	252
127402, 24U765	6 (1.8)	165
127404, 24U766	8 (2.4)	123
126389, 24U767	10 (3.0)	97
127405, 24U768	12 (3.6)	81
127406, 24U769	14 (4.2)	69
127407, 24U771	16 (4.8)	60
127408, 24U772	18 (5.4)	54
126483, 24U773	20 (6.0)	48
127409, 24U774	22 (6.7)	53
126534, 24U776	25 (7.6)	46

Any resistance reading outside the range indicates that the hose must be replaced.

The resistance values of the RTD will vary with temperature. An approximation of hose temperature must be made to verify the resistance reading of the RTD across pin M and K is correct.

- b. Between pins M and K of the large melter end connector, the RTD resistance must be within the range of the following chart.

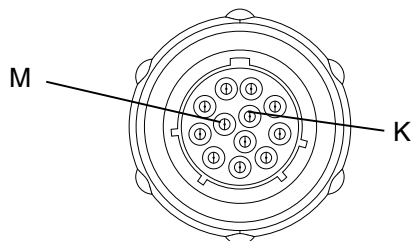

Approximate RTD resistance values at various temperatures.

Temperature		Pins M and K Approximate Resistance Values (ohms)
°C	°F	
16	60	106
27	80	110
38	100	115
49	120	119
60	140	123
71	160	128
82	180	132
93	200	136
104	220	140
116	240	144
127	260	149
138	280	153
149	300	160
160	320	161
171	340	165
182	360	170
193	380	174
204	400	177

2. **Check all hose connections** to be sure they are securely tightened.
3. **Ground the system.** See system manual for instructions.
4. Make sure there is electrical continuity (<10 Ω) between the following pins of the large melter end connector and the small gun end connector.
5. Lack of electrical continuity between any of these pins indicates the hose must be replaced.

Continuity Between Connectors	
Melter End	Gun End
J	A
A	C
K	E
G	D
GND	GND

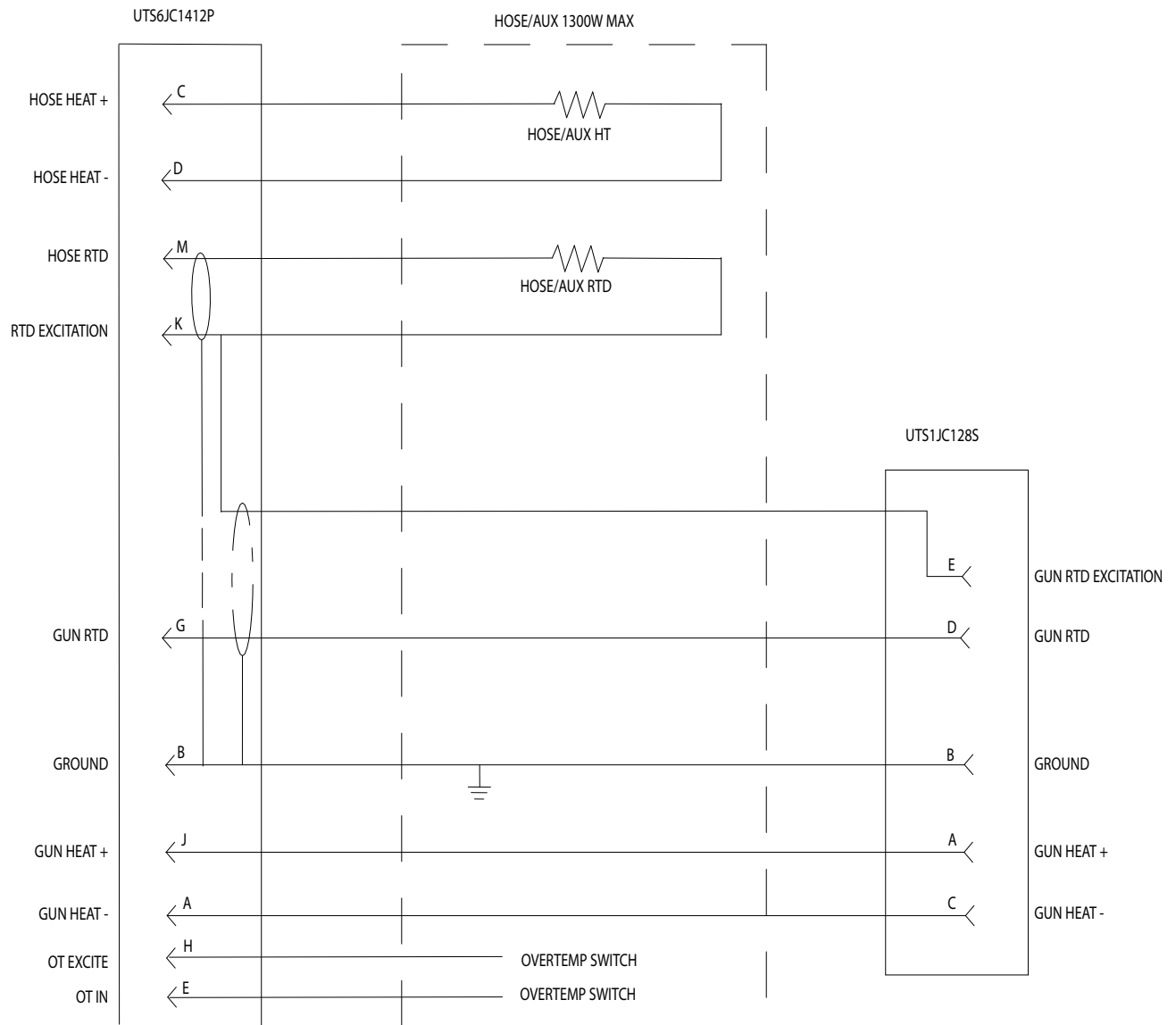
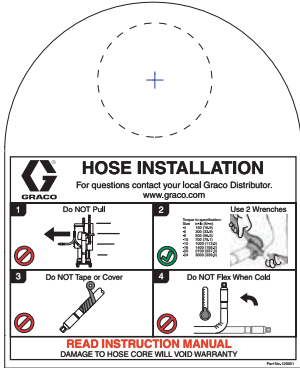

FIG. 3

Parts

Replacement Warning labels, signs, tags, and cards are available at no cost.

Heated Hose Instruction Tag, 120051



Heated Hose Warning Label, 196694

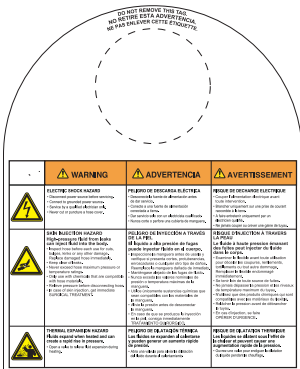

Water-wash Heated Hose Instruction Tag, 17A202

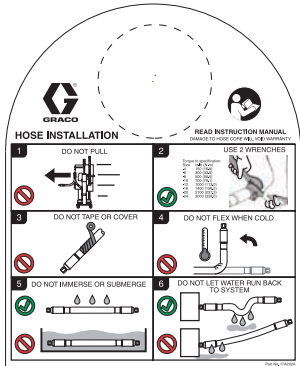

Accessories

Self-Sealing Silicone Rubber Tape, 16Y938 (12 yd / 11 m roll)

Wrap around Water-wash cable connectors to provide an extra level of protection.

Instructions: Remove plastic backing and wrap tightly around electrical cable connectors. Silicone rubber tape will adhere to itself and fuse with a cure time 24 hours at room temperature to provide a strong, fluid-tight seal.

Hose Hanger Spring Kit, 253283

Use spring kit to hang hose overhead without kinking.

Ref.	Part	Description	Qty.
1	C34132	HANGER	1
2	119958	SPRING, hose hanger	1

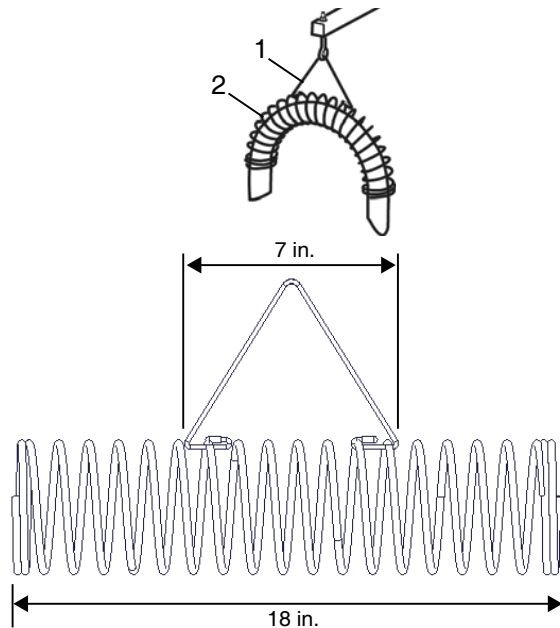

Retaining Strap Kit

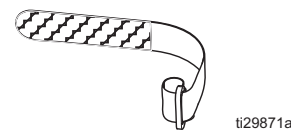

Part	Description	Qty.
114271	RETAINING STRAP, individual	1
240296	KIT, retaining strap	4

Technical Data

InvisiPac Heated Hose		
	US	Metric
Maximum fluid working pressure	1500 psi	10 MPa, 103 bar
Maximum hose operating temperature	400° F	204° C
Hose fluid fittings	0.31 ID (9/16-18 JIC(f))	
Power required	230 VAC, 50/60 Hz	
Wetted Parts	PTFE core, SST couplings	
Power consumption	See Standard Model Hoses on page 2	
Minimum bend radius	8 in. (203 mm)	

Graco Standard Warranty

Graco warrants all equipment referenced in this document which is manufactured by Graco and bearing its name to be free from defects in material and workmanship on the date of sale to the original purchaser for use. With the exception of any special, extended, or limited warranty published by Graco, Graco will, for a period of eighteen months from the date of sale, repair or replace any part of the equipment determined by Graco to be defective. This warranty applies only when the equipment is installed, operated and maintained in accordance with Graco's written recommendations.

This warranty does not cover, and Graco shall not be liable for general wear and tear, or any malfunction, damage or wear caused by faulty installation, misapplication, abrasion, corrosion, inadequate or improper maintenance, negligence, accident, tampering, or substitution of non-Graco component parts. Nor shall Graco be liable for malfunction, damage or wear caused by the incompatibility of Graco equipment with structures, accessories, equipment or materials not supplied by Graco, or the improper design, manufacture, installation, operation or maintenance of structures, accessories, equipment or materials not supplied by Graco.

This warranty is conditioned upon the prepaid return of the equipment claimed to be defective to an authorized Graco distributor for verification of the claimed defect. If the claimed defect is verified, Graco will repair or replace free of charge any defective parts. The equipment will be returned to the original purchaser transportation prepaid. If inspection of the equipment does not disclose any defect in material or workmanship, repairs will be made at a reasonable charge, which charges may include the costs of parts, labor, and transportation.

THIS WARRANTY IS EXCLUSIVE, AND IS IN LIEU OF ANY OTHER WARRANTIES, EXPRESS OR IMPLIED, INCLUDING BUT NOT LIMITED TO WARRANTY OF MERCHANTABILITY OR WARRANTY OF FITNESS FOR A PARTICULAR PURPOSE.

Graco's sole obligation and buyer's sole remedy for any breach of warranty shall be as set forth above. The buyer agrees that no other remedy (including, but not limited to, incidental or consequential damages for lost profits, lost sales, injury to person or property, or any other incidental or consequential loss) shall be available. Any action for breach of warranty must be brought within two (2) years of the date of sale.

GRACO MAKES NO WARRANTY, AND DISCLAIMS ALL IMPLIED WARRANTIES OF MERCHANTABILITY AND FITNESS FOR A PARTICULAR PURPOSE, IN CONNECTION WITH ACCESSORIES, EQUIPMENT, MATERIALS OR COMPONENTS SOLD BUT NOT MANUFACTURED BY GRACO. These items sold, but not manufactured by Graco (such as electric motors, switches, hose, etc.), are subject to the warranty, if any, of their manufacturer. Graco will provide purchaser with reasonable assistance in making any claim for breach of these warranties.

In no event will Graco be liable for indirect, incidental, special or consequential damages resulting from Graco supplying equipment hereunder, or the furnishing, performance, or use of any products or other goods sold hereto, whether due to a breach of contract, breach of warranty, the negligence of Graco, or otherwise.

FOR GRACO CANADA CUSTOMERS

The Parties acknowledge that they have required that the present document, as well as all documents, notices and legal proceedings entered into, given or instituted pursuant hereto or relating directly or indirectly hereto, be drawn up in English. Les parties reconnaissent avoir convenu que la rédaction du présente document sera en Anglais, ainsi que tous documents, avis et procédures judiciaires exécutés, donnés ou intentés, à la suite de ou en rapport, directement ou indirectement, avec les procédures concernées.

Graco Information

For more information about InvisiPac, visit www.InvisiPac.com or email InvisiPac@graco.com.

TO PLACE AN ORDER, contact your Graco distributor or call to identify the nearest distributor.

For technical assistance or customer service, call toll free: 1-800-458-2133.

*All written and visual data contained in this document reflects the latest product information available at the time of publication.
Graco reserves the right to make changes at any time without notice.*

Original instructions. This manual contains English. MM 332072

Graco Headquarters: Minneapolis

International Offices: Belgium, China, Japan, Korea

GRACO INC. AND SUBSIDIARIES • P.O. BOX 1441 • MINNEAPOLIS MN 55440-1441 • USA

Copyright 2012, Graco Inc. All Graco manufacturing locations are registered to ISO 9001.

www.graco.com

Revision T, July 2021