

AIR-DRIVEN

Twistork[®] Helix Agitator

308175T

EN

***Air driven agitator for mixing and maintaining suspension of industrial coatings.
For professional use only.***

100 psi (0.7 MPa, 7 bar) Maximum Working Pressure

See page 2 for model information.



Important Safety Instructions

Read all warnings and instructions in this manual before using the equipment.
Save these instructions.

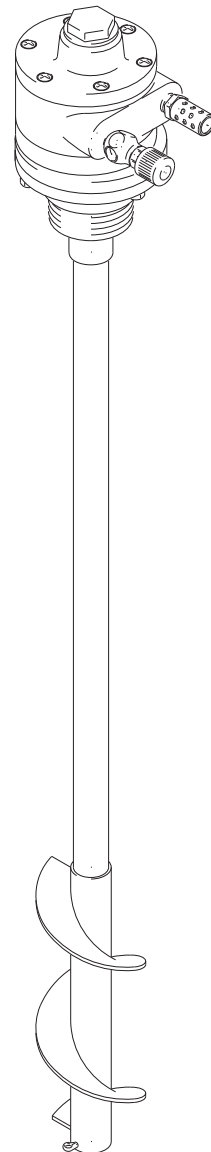

II 1/2 G Ex h IIB T3 Ga/Gb
ITS03ATEX11226X
ITS21UKEX0224X

Contents









Models	2	Maintenance	8
Warnings	3	Flush the Air Motor	8
Installation	5	Agitator Blades	8
Air Requirements	5	Lubricate the Air Motor	8
Air Line Accessories	5	Service	9
Install the Agitator	6	Align the Outlet Housing	9
Grounding	6	Parts	10
Operation	7	Model 224854 Twistork Helix Agitator	10
Find the Proper Agitator Speed	7	Model 235534 Twistork Helix Agitator	12
Pressure Relief Procedure	7	Dimensions	14
Operate the Agitator	7	Technical Specifications	15
Check Fluid Viscosity	7	California Proposition 65	15
		Graco Standard Warranty	16

Models





Part	Series	Description
224854	D	Carbon Steel Agitator
235534	D	Stainless Steel Agitator

Warnings

The following warnings are for the setup, use, grounding, maintenance, and repair of this equipment. The exclamation point symbol alerts you to a general warning and the hazard symbols refer to procedure-specific risks. When these symbols appear in the body of this manual or on warning labels, refer back to these Warnings. Product-specific hazard symbols and warnings not covered in this section may appear throughout the body of this manual where applicable.

 <h1 style="margin: 0;">WARNING</h1>	
   	<p>FIRE AND EXPLOSION HAZARD</p> <p>Flammable fumes, such as solvent and paint fumes, in work area can ignite or explode. Paint or solvent flowing through the equipment can cause static sparking. To help prevent fire and explosion:</p> <ul style="list-style-type: none"> • Use equipment only in well-ventilated area. • Eliminate all ignition sources, such as pilot lights, cigarettes, portable electric lamps, and plastic drop cloths (potential static sparking). • Ground all equipment in the work area. See Grounding instructions. • Never spray or flush solvent at high pressure. • Keep work area free of debris, including solvent, rags and gasoline. • Do not plug or unplug power cords, or turn power or light switches on or off when flammable fumes are present. • Use only grounded hoses. • Hold gun firmly to side of grounded pail when triggering into pail. Do not use pail liners unless they are anti-static or conductive. • Stop operation immediately if static sparking occurs or you feel a shock. Do not use equipment until you identify and correct the problem. • Keep a working fire extinguisher in the work area.
 	<p>MOVING PARTS HAZARD</p> <p>Moving parts can pinch, cut or amputate fingers and other body parts.</p> <ul style="list-style-type: none"> • Keep clear of moving parts. • Do not operate equipment with protective guards or covers removed. • Do not wear loose clothing, jewelry or long hair while operating equipment. • Equipment can start without warning. Before checking, moving, or servicing equipment, follow the Pressure Relief Procedure and disconnect all power sources.
	<p>SPECIAL CONDITIONS FOR SAFE USE</p> <ul style="list-style-type: none"> • Electrostatic charging hazard. Clean surfaces with a damp cloth and read instructions for additional techniques to mitigate risk of electrostatic discharge. • The Ambient Temperature Range of each agitator depends on the air motor included in the assembly. Refer to Models and Technical Specifications in Instruction manual for additional information.

WARNING

 	<p>EQUIPMENT MISUSE HAZARD</p> <p>Misuse can cause death or serious injury.</p> <ul style="list-style-type: none"> • Do not operate the unit when fatigued or under the influence of drugs or alcohol. • Do not exceed the maximum working pressure or temperature rating of the lowest rated system component. See Technical Specifications in all equipment manuals. • Use fluids and solvents that are compatible with equipment wetted parts. See Technical Specifications in all equipment manuals. Read fluid and solvent manufacturer's warnings. For complete information about your material, request Safety Data Sheets (SDSs) from distributor or retailer. • Do not leave the work area while equipment is energized or under pressure. • Turn off all equipment and follow the Pressure Relief Procedure when equipment is not in use. • Check equipment daily. Repair or replace worn or damaged parts immediately with genuine manufacturer's replacement parts only. • Do not alter or modify equipment. Alterations or modifications may void agency approvals and create safety hazards. • Make sure all equipment is rated and approved for the environment in which you are using it. • Use equipment only for its intended purpose. Call your distributor for information. • Route hoses and cables away from traffic areas, sharp edges, moving parts, and hot surfaces. • Do not kink or over bend hoses or use hoses to pull equipment. • Keep children and animals away from work area. • Comply with all applicable safety regulations.
 	<p>TOXIC FLUID OR FUMES HAZARD</p> <p>Toxic fluids or fumes can cause serious injury or death if splashed in the eyes or on skin, inhaled, or swallowed.</p> <ul style="list-style-type: none"> • Read Safety Data Sheets (SDSs) to know the specific hazards of the fluids you are using. • Store hazardous fluid in approved containers, and dispose of it according to applicable guidelines.
	<p>PERSONAL PROTECTIVE EQUIPMENT</p> <p>Wear appropriate protective equipment when in the work area to help prevent serious injury, including eye injury, hearing loss, inhalation of toxic fumes, and burns. Protective equipment includes but is not limited to:</p> <ul style="list-style-type: none"> • Protective eyewear and hearing protection. • Respirators, protective clothing, and gloves as recommended by the fluid and solvent manufacturer.

Installation

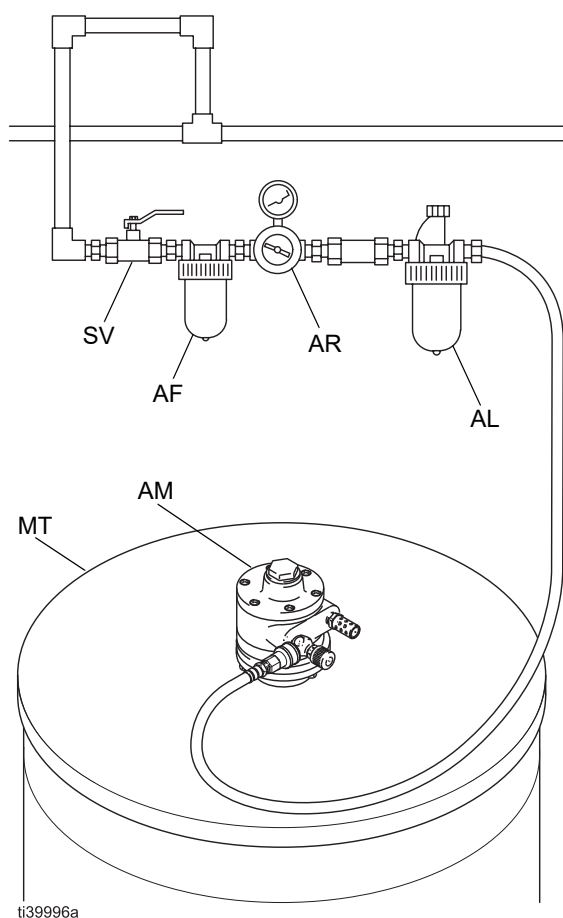
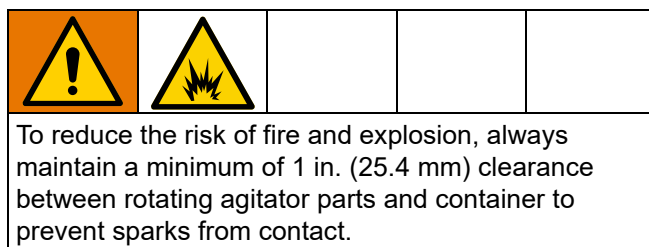

FIG. 1: Typical Installation

Key:

- SV: Bleed-type air shutoff valve
- AF: Air line filter
- AR: Air regulator and gauge
- AL: Air line lubricator
- AM: Agitator motor
- MT: Mix tank (reference only)

NOTE: Reference numbers and letters in parentheses refer to the callouts in the figures and in **Parts**, page 10.

Air Requirements

For continuous use, the 1/2 HP agitator air motor typically requires 2 scfm (0.06 m³/min.) of air at 400 rpm and with 100 psi (7 bar) inlet pressure.

Air Line Accessories

A bleed-type air shutoff valve (SV) is required; it isolates the air line components for servicing. The air shutoff valve should be installed in the supply line and can be used to stop and start the agitator. If the valve is used to stop and start the agitator, you do not need to set the agitator speed each time it is used.

Order air shutoff valves by the part numbers listed below:

- 110223** 1/4" npt(f) x 1/4" npt(f)
- 110224** 3/8" npt(f) x 3/8" npt(f)
- 113333** 3/8" npt(m) x 3/8" npt(f)

Install an air line filter (AF) to remove harmful dirt and moisture from the air supply. To order an air line filter, order by the part numbers listed below:

- 106148** 3/8" npt, 20-micron element, 5 oz. bowl, without gauge
- 106146** 1/2" npt, 40-micron element, 40 oz. bowl, 0 to 200 psi (0 to 14 bar) regulated pressure range

NOTICE

Not lubricating the air motor will cause air motor failure.

Downstream from the filter, install an air line lubricator (AL) for automatic air motor lubrication. Set the lubricator feed rate at 1 drop of oil per minute for high speed or continuous duty usage. Do not overfeed oil or exhaust air may become contaminated. To manually lubricate the air motor, see **Lubricate the Air Motor**, page 8. To order a 3/8" npt air line lubricator, order part number 214847.

Install the Agitator

1. Install the agitator on the container cover by screwing the helix through the drum bung hole and screwing the agitator housing into the bung hole. Refer to **Dimensions**, page 14.

NOTICE

Keep the agitator tightly mounted to the drum bung to prevent damage to the threads from vibration.

When using a modified drum, check that there is no interference between the base of the drum and the shaft of the agitator.

2. Position the air motor so the air line can easily be attached to the needle valve's 1/8 npt inlet, without obstructing any other system components. See FIG. 2.
3. Attach a bleed-type air shutoff valve (SV) for main air shutoff. Optionally, attach an air line disconnect valve. Order part number 208536, coupler and 169969 fitting, quick disconnect air line fitting.
4. Attach the air line between the needle valve's 1/8 npt inlet and the 1/8 npt air supply manifold outlet.

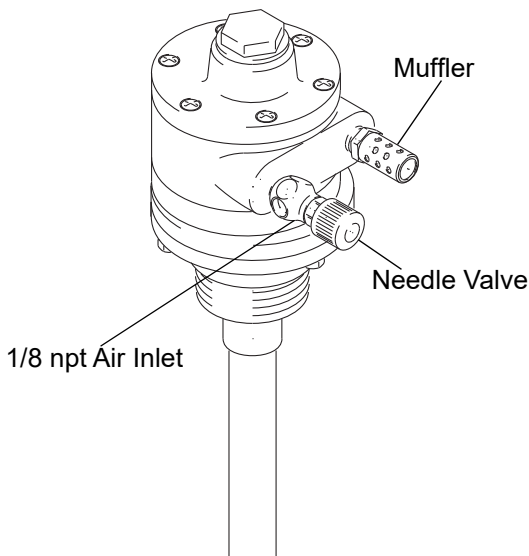

FIG. 2: Agitator Installation

Grounding



The equipment must be grounded to reduce the risk of static sparking. Static sparking can cause fumes to ignite or explode. To reduce the risk of static sparking, all electrically conductive objects or devices in the spray area must be properly grounded.

Check your local electrical code for detailed grounding instructions for your area and type of equipment.

Remove the grounding screw (A) and lockwasher (B). See FIG. 3. Secure the ground wire terminal (C) to the agitator with the screw and lockwasher. Connect the other end of the ground wire to a true earth ground.

Order part number 222011, ground wire and clamp.

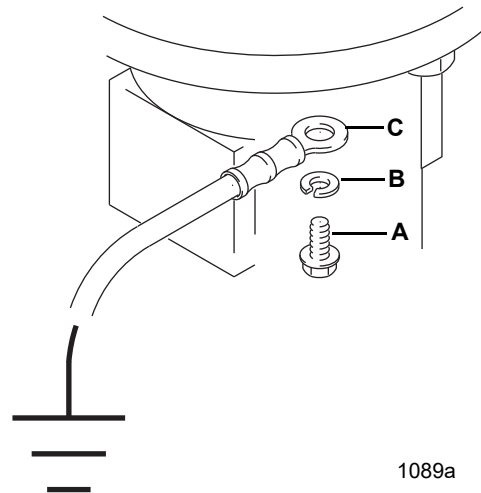





FIG. 3: Ground the Agitator

Operation





				
<p>Moving parts, such as an impeller blade, can cut or amputate fingers. To reduce the risk of serious injury, always shut off the agitator and disconnect the air line before moving, checking, or repairing the agitator.</p>				

Find the Proper Agitator Speed

NOTE: Attach ground wire before using agitator.

1. Fill the fluid supply container to about 3–4 inches (75–100 mm) above the agitator blade.
2. Start the agitator, and gradually increase the speed by turning the needle valve (11) until a vortex begins to form in the paint.
3. Reduce the speed slightly, then fill the fluid container. Use the lowest agitator speed needed for thorough agitation of the paint. Excessive agitator speed may cause the paint to foam.

Pressure Relief Procedure

				
<p>This equipment stays pressurized until pressure is manually relieved. To help prevent serious injury from splashing fluid and moving parts, follow the Pressure Relief Procedure before cleaning, checking, or servicing the equipment.</p>				

1. Close the bleed-type air shutoff valve (SV) to relieve pressure to the air motor.
2. Disconnect the air line.

Operate the Agitator

NOTICE
<p>To avoid damaging the equipment, do not operate the agitator at a high speed for a long period of time. Excessive agitator speed can cause foaming of fluid (making the fluid unusable), vibration, and increased wear on parts. Only agitate the fluid enough to maintain even mixing.</p>

Operate the agitator continuously while supplying paints or other fluids to the system. Use the needle valve (11) to regulate the agitator speed. Set the agitator speed to thoroughly mix the paint, using the lowest speed possible.

To stop the agitator, close the bleed-type air shutoff valve (SV) or close the needle valve (11).



Stop the agitator and disconnect the air line before removing it from the container.





Check Fluid Viscosity

If the agitator is in a closed drum, the agitator must be removed to check the fluid viscosity or the fluid must be siphoned from the 3/4 npt drum port.

Maintenance

Flush the Air Motor

				
Do not use kerosene or other flammable solvents to flush the air motor. Flushing with flammable solvents could cause fire or explosion and result in serious injury or property damage.				



				
Hazardous fluids or toxic fumes can cause serious injury or death if splashed in the eyes or on the skin, swallowed, or inhaled. When flushing the air motor:				
<ul style="list-style-type: none"> • Perform the procedure in a well ventilated area. • Keep your face away from the exhaust port. • Wear the appropriate protective clothing, gloves, eyewear, and respirator. 				

If the air motor is sluggish or inefficient, follow this procedure.

The recommended solvent for air motors and lubricated pumps is Gast[®] Flushing Solvent (Gast part number AH255 or AH255A) or Inhibisol[®] Safety Solvent.

1. Disconnect the air line and muffler (1a). See **Parts** on page 10.
2. Add several teaspoons of solvent, or spray the solvent directly into the motor.
3. Rotate the shaft by hand in both directions for a few minutes.
4. Reconnect the air line, and slowly increase the air pressure until there is not trace of solvent in the exhaust air.
5. Re-lubricate the motor with a squirt of lightweight oil in the chamber.

Agitator Blades

				
Materials can become electrostatically charged when stirred or blended. To prevent fire and explosion, ground equipment and do not allow material to build up on agitator. Dried material could allow static build up and interfere with grounding.				

Regularly check the agitator for dried material buildup. Clean using a rag soaked in solvent that is compatible with the spray material and the surfaces being cleaned. Additionally, extra precautions need to be taken if using lower conductive materials (<1000 pS/m) such as:

- Avoid stirring/mixing at high speeds.
- Avoid insoluble mixtures.
- When possible, increase the material conductivity with additives.
- Use liquids with a high conductivity (>1000 pS/m)

Lubricate the Air Motor

NOTICE
Not lubricating the air motor will cause air motor failure.

If an air line lubricator (AL) is not installed, the air motor must be manually lubricated every 8 hours. Lubricate the agitator air motor by placing 10–20 drops of SAE #10 light oil in the motor's air inlet. Oil must have an auto-ignition rating of 365°F (185°C) or greater. Run the agitator for about 30 seconds.

Service

If the unit requires more than installation of a service kit, it is usually quickest and easiest to send the unit to the Graco distributor for repair or replacement.

NOTICE

Do not pry with a screwdriver. It will dent the surface of the plate and body, causing leaks. Use a puller tool, which will remove the end plate while maintaining the position of the shaft.

- If the vanes need replacing or foreign material is present in the motor chamber, an experienced mechanic may remove the end plate opposite the drive shaft end.
- New vanes should have the edges with cut corners (or the notched edges, if the vanes are reversible) pointing toward the bottom of the vane slot.

NOTE: An Air Motor Repair Kit is available. Order part number 224954.

Align the Outlet Housing

NOTICE

Improper installation of the outlet housing could cause the agitator shaft to bind against the outlet housing bearing and damage it.

Follow these steps after performing any of the following:

- Replacing the outlet housing (4).
 - Replacing the air motor (1).
 - Repairing the agitator.
1. Place the agitator in a vertical position and loosen the three outlet housing screws (17). See **Parts**, page 10.
 2. Apply 25 psi (1.7 bar) minimum air pressure to the air motor. Adjust the needle valve so the agitator is barely turning.
 3. While the agitator shaft is turning, torque the three outlet housing screws to 80 to 100 in-lbs (9 to 11.3 N•m).
 4. If the agitator shaft still binds, repeat steps 1 to 3 above.

Parts



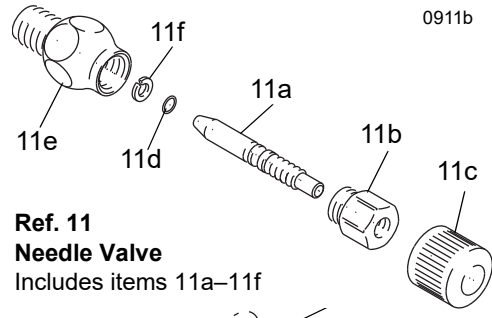
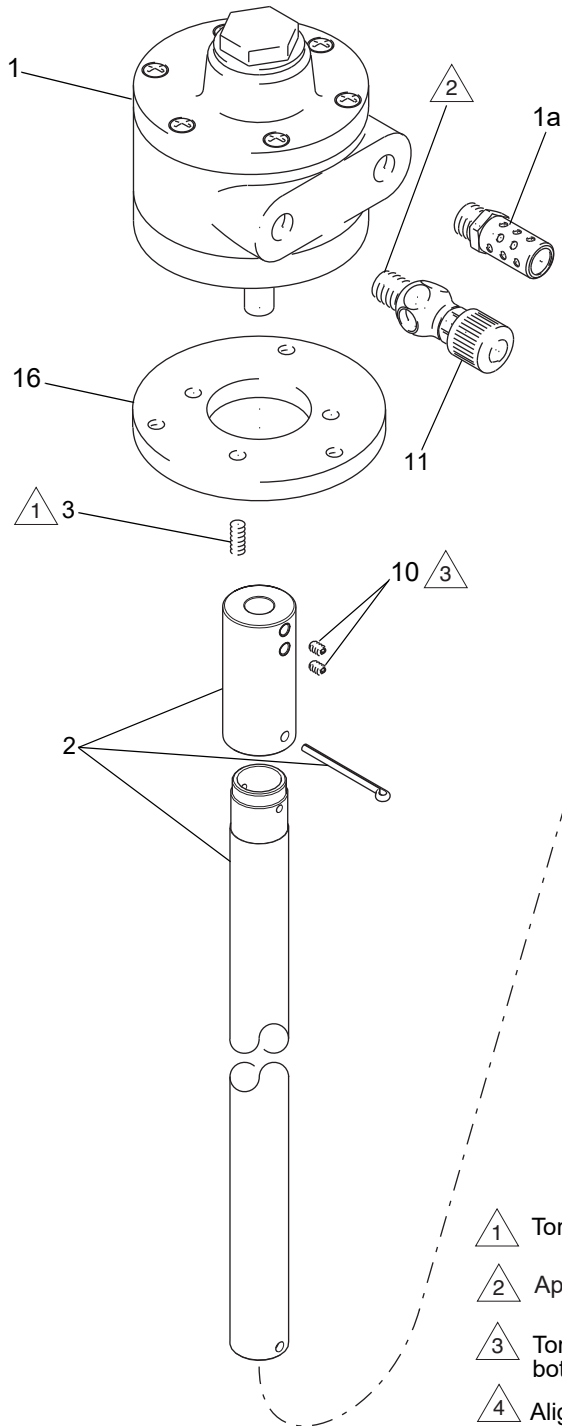

Model 224854 Twistork Helix Agitator

Carbon Steel, Includes items 1 to 22



**Ref. 11
Needle Valve**
Includes items 11a-11f

0911b

-  Torque to 80-100 in-lbs (9-11.3 N•m).
-  Apply medium grade sealant to external threads.
-  Torque to 34-40 in-lbs (4-4.5 N•m). Be sure air motor shaft bottoms out in mounting hole before tightening.
-  Align as instructed on page 9.

907c

Model 224854 Twistork Helix Agitator

Ref.	Part	Description	Qty.
1*	111310	MOTOR, air; Includes item 1a	1
1a	113779	MUFFLER, exhaust	1
2	224852	SHAFT, agitator	1
3	101550	SCREW, cap, sch; 1/2-20 X 0.5	3
4	224876	HOUSING, outlet, carbon steel	1
6	224393	HELIX, agitator	1
7	187054	PLUG, fluid tube	1
8^	101946	PIN, cotter	1
9^	111312	O-RING, Fluoroelastomer	1
10	112364	SCREW, set, socket; 1/4-20 UNC 3A	2
11	206264	VALVE, needle Includes items 11a to 11f	1
11a	166529	VALVE, needle	1
11b	166532	NUT, packing	1
11c	164698	KNOB, adjusting	1
11d	157628	O-RING, packing	1
11e	165722	BODY, valve	1
11f	166531	WASHER	1
16	187577	PLATE, motor mounting	1
17	102023	SCREW, cap, hex hd; 1/4-20 x 0.75	3
20	111593	SCREW, grounding; hex, No. 8-32	1
22	157021	WASHER, lock	1
29▲	17P806	KIT, safety tag (not shown)	1

* *Repair Kit 224954 used to rebuild air motor 111310, may be purchased separately.*

^ *Keep these spare parts on hand to reduce down time.*

▲ *Replacement safety labels, tags, and cards are available at no cost.*

Model 235534 Twistork Helix Agitator



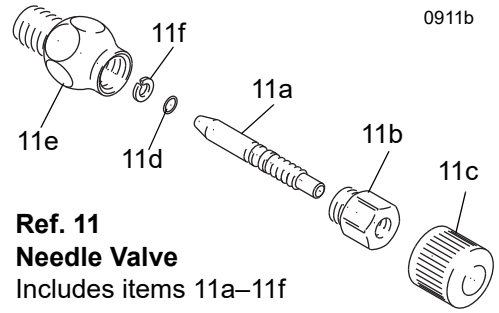
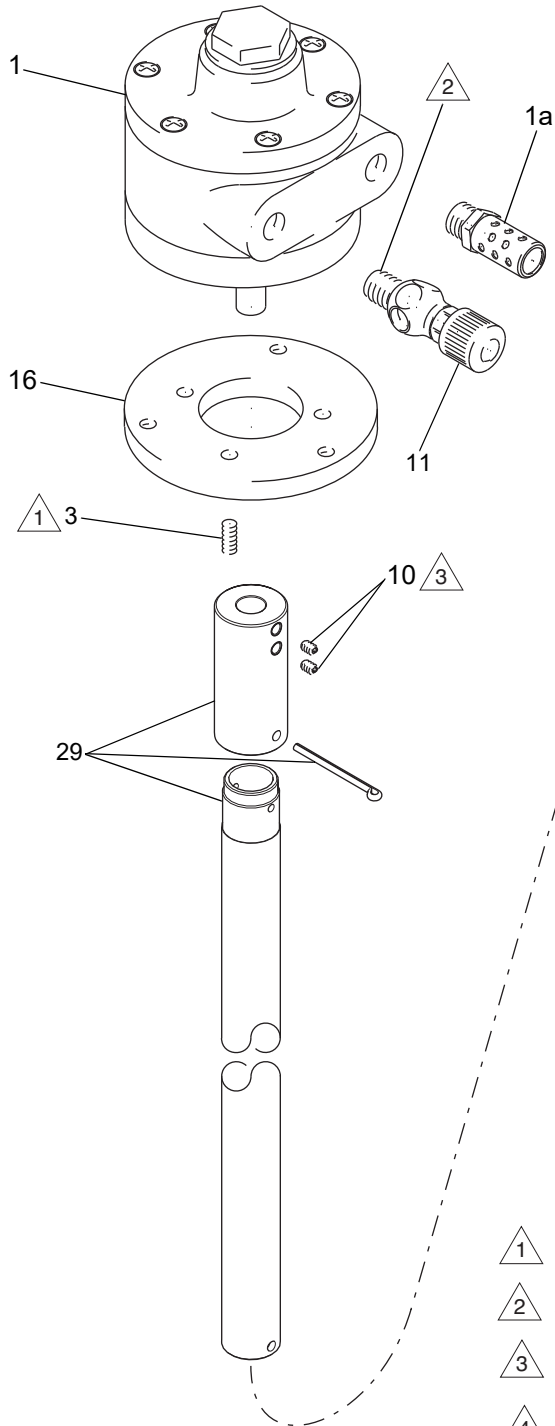

Stainless Steel, Includes items 1 to 29

0911b

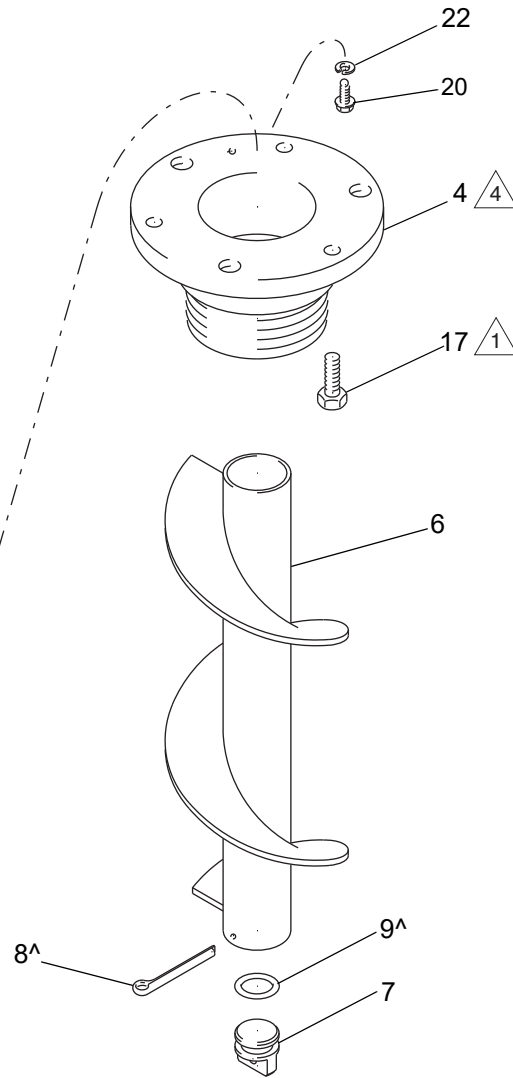

**Ref. 11
Needle Valve**
Includes items 11a–11f



-  Torque to 80-100 in-lbs (9-11.3 N•m).
-  Apply medium grade sealant to external threads.
-  Torque to 34-40 in-lbs (4-4.5 N•m). Be sure air motor shaft bottoms out in mounting hole before tightening.
-  Align as instructed on page 9. 907c

Model 235534 Twistork Helix Agitator

Ref.	Part	Description	Qty.
1*	111310	MOTOR, air; Includes item 1a	1
1a	113779	MUFFLER, exhaust	1
3	101550	SCREW, cap, sch; 1/2-20 X 0.5	3
4	235535	HOUSING, outlet, carbon steel	1
6	224393	HELIX, agitator	1
7	187054	PLUG, fluid tube	1
8^	101946	PIN, cotter	1
9^	111312	O-RING, Fluoroelastomer	1
10	112364	SCREW, set, socket; 1/4-20 UNC 3A	2
11	206264	VALVE, needle Includes items 11a to 11f	1
11a	166529	VALVE, needle	1
11b	166532	NUT, packing	1
11c	164698	KNOB, adjusting	1
11d	157628	O-RING, packing	1
11e	165722	BODY, valve	1
11f	166531	WASHER	1
16	187577	PLATE, motor mounting	1
17	102023	SCREW, cap, hex hd; 1/4-20 x 0.75	3
20	111593	SCREW, grounding; hex, No. 8-32	1
22	157021	WASHER, lock	1
26▲	17P806	KIT, safety tag (not shown)	1
29	235530	SHAFT, agitator	1

* *Repair Kit 224954 used to rebuild air motor 111310, may be purchased separately.*

^ *Keep these spare parts on hand to reduce down time.*

▲ *Replacement safety labels, tags, and cards are available at no cost.*

Dimensions

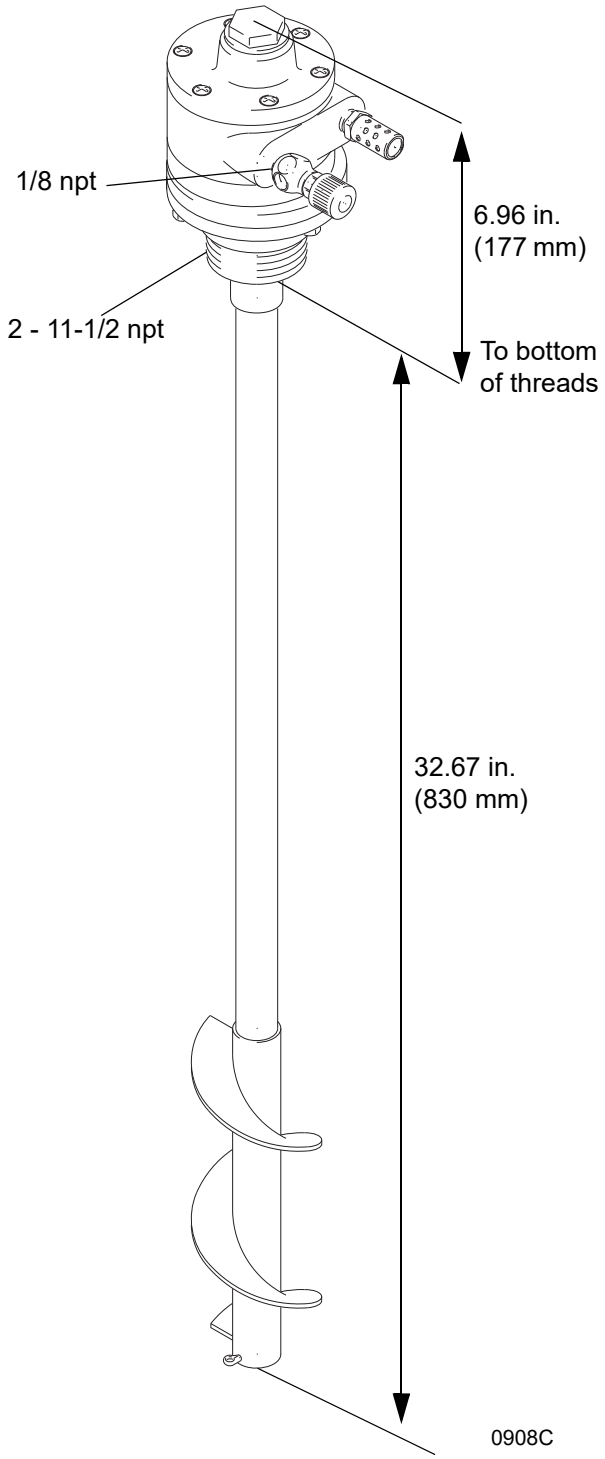

Technical Specifications

Air-Driven Twistork Helix Agitator	US	Metric
Maximum working pressure	100 psi	0.7 MPa, 7 bar
Maximum recommended agitator speed	800 rpm	800 rpm
Air consumption at 800 rpm with 100 psi (7 bar) air inlet pressure	5 scfm	0.14 m3/min.
Air consumption at 400 rpm with 100 psi (7 bar) air inlet pressure	2 scfm	0.06 m3/min.
Ambient operating temperature range	+33.8° F < Ta < +104° F	+1° C < Ta < +40° C
Wetted Parts		
Model 224854	Carbon Steel, Fluoroelastomer, Acetal	
Model 235534	304 & 316 Stainless Steel, Fluoroelastomer, Acetal	
Noise (dBA)	Pressure	Power
Noise level at 100 psi normal load at 800 rpm*	71.3 dB(A)	84.6 dB(A)
Noise level at 100 psi at no load at max rpm*	84.1 dB(A)	97.4 dB(A)
*Tested to CAGI-PNEUROP-1969		
External parts that may come in contact with fluids	Material	
Plate	Carbon Steel	
Air Motor	Aluminum	
Weight		
All models	17 lb.	8 kg
Notes		
<i>Gast® is a registered trademark of Gast Manufacturing.</i> <i>Inhibisol® is a registered trademark of Penetone Corp.</i>		

California Proposition 65

CALIFORNIA RESIDENTS

 **WARNING:** Cancer and reproductive harm – www.P65warnings.ca.gov.

Graco Standard Warranty

Graco warrants all equipment referenced in this document which is manufactured by Graco and bearing its name to be free from defects in material and workmanship on the date of sale to the original purchaser for use. With the exception of any special, extended, or limited warranty published by Graco, Graco will, for a period of twelve months from the date of sale, repair or replace any part of the equipment determined by Graco to be defective. This warranty applies only when the equipment is installed, operated and maintained in accordance with Graco's written recommendations.

This warranty does not cover, and Graco shall not be liable for general wear and tear, or any malfunction, damage or wear caused by faulty installation, misapplication, abrasion, corrosion, inadequate or improper maintenance, negligence, accident, tampering, or substitution of non-Graco component parts. Nor shall Graco be liable for malfunction, damage or wear caused by the incompatibility of Graco equipment with structures, accessories, equipment or materials not supplied by Graco, or the improper design, manufacture, installation, operation or maintenance of structures, accessories, equipment or materials not supplied by Graco.

This warranty is conditioned upon the prepaid return of the equipment claimed to be defective to an authorized Graco distributor for verification of the claimed defect. If the claimed defect is verified, Graco will repair or replace free of charge any defective parts. The equipment will be returned to the original purchaser transportation prepaid. If inspection of the equipment does not disclose any defect in material or workmanship, repairs will be made at a reasonable charge, which charges may include the costs of parts, labor, and transportation.

THIS WARRANTY IS EXCLUSIVE, AND IS IN LIEU OF ANY OTHER WARRANTIES, EXPRESS OR IMPLIED, INCLUDING BUT NOT LIMITED TO WARRANTY OF MERCHANTABILITY OR WARRANTY OF FITNESS FOR A PARTICULAR PURPOSE.

Graco's sole obligation and buyer's sole remedy for any breach of warranty shall be as set forth above. The buyer agrees that no other remedy (including, but not limited to, incidental or consequential damages for lost profits, lost sales, injury to person or property, or any other incidental or consequential loss) shall be available. Any action for breach of warranty must be brought within two (2) years of the date of sale.

GRACO MAKES NO WARRANTY, AND DISCLAIMS ALL IMPLIED WARRANTIES OF MERCHANTABILITY AND FITNESS FOR A PARTICULAR PURPOSE, IN CONNECTION WITH ACCESSORIES, EQUIPMENT, MATERIALS OR COMPONENTS SOLD BUT NOT MANUFACTURED BY GRACO. These items sold, but not manufactured by Graco (such as electric motors, switches, hose, etc.), are subject to the warranty, if any, of their manufacturer. Graco will provide purchaser with reasonable assistance in making any claim for breach of these warranties.

In no event will Graco be liable for indirect, incidental, special or consequential damages resulting from Graco supplying equipment hereunder, or the furnishing, performance, or use of any products or other goods sold hereto, whether due to a breach of contract, breach of warranty, the negligence of Graco, or otherwise.

FOR GRACO CANADA CUSTOMERS

The Parties acknowledge that they have required that the present document, as well as all documents, notices and legal proceedings entered into, given or instituted pursuant hereto or relating directly or indirectly hereto, be drawn up in English. Les parties reconnaissent avoir convenu que la rédaction du présente document sera en Anglais, ainsi que tous documents, avis et procédures judiciaires exécutés, donnés ou intentés, à la suite de ou en rapport, directement ou indirectement, avec les procédures concernées.

Graco Information

For the latest information about Graco products, visit www.graco.com.

For patent information, see www.graco.com/patents.

TO PLACE AN ORDER, contact your Graco distributor or call to identify the nearest distributor.

Phone: 612-623-6921 **or Toll Free:** 1-800-328-0211, **Fax:** 612-378-350

*All written and visual data contained in this document reflects the latest product information available at the time of publication.
Graco reserves the right to make changes at any time without notice.*

Original instructions. This manual contains English. MM 308175

Graco Headquarters: Minneapolis

International Offices: Belgium, China, Japan, Korea

GRACO INC. AND SUBSIDIARIES • P.O. BOX 1441 • MINNEAPOLIS MN 55440-1441 • USA
Copyright 1991, Graco Inc. All Graco manufacturing locations are registered to ISO 9001.

www.graco.com
Revision T, August 2021